

# Surgical Instrument Catalogue

Version 4



Proud to be a family-run,  
British manufacturer based  
in Southend-on-Sea, Essex,  
trading for over 30 years

## Working in close partnership with our customers, we manufacture innovative and bespoke instrumentation.

We have over 50 years of knowledge and experience in our workshop. Our team of highly skilled technicians undertake a minimum apprenticeship of 5 years and are trained to manufacture instruments, rather than just repair them. This gives us 360 degree understanding of the challenge and the importance of correctly functioning medical devices.



We care immensely about the work we do, never forgetting that instruments we create and repair are responsible for saving lives.

We insist on controlling the quality of every item we manufacture, from the materials used to the rigorous procedures we apply to testing. Our range of supporting products are serviced and repaired in-house, ensuring we are always able to exceed our customers' expectations.

Customers can receive training, participate in factory visits or simply call their local representative for guidance with instrumentation or management.

Skill-sharing has been at the heart of our business for four generations and we frequently arrange workshops and attend events at which we can educate others.

## Our Team Values, Vision and Mission:



**TEAMWORK**  
Maintain a family team atmosphere



**PASSION**  
Work with passion and accountability



**SAFETY**  
Demand a clean and safe working environment



**AMBITION**  
Have ambition for innovative growth



**ADAPTABILITY**  
Be adaptable to customer requirements



**QUALITY**  
Uphold commitment for quality and improvement



**EDUCATION**  
Foster skilfulness and share education



**ACCURACY**  
Deliver full and accurate information

## Contents

About Surgical Holdings	2
Our Services	5
Case Study	8
General Instruments	9
Dental	46
Diathermy/Bipolar	54
ENT	59
Gynaecology	89
Intestinal	109
Neuro/Spinal Surgery	114
Ophthalmic/Micro	131
Orthopaedic	139
Plastic/Oral	180
Post Mortem/Autopsy	193
Proctology	205
Thoracic	211
Urology	228
Index	233

## Quality Assurance

We are an ISO 13485 accredited company.

Our comprehensive quality management system is in accordance with the requirements of the Medical Device Directive 93/42/EEC - Annex I & II, for temporary orthopaedic surgical implants - skeletal pins, wires, staples, guide wires - and all associated instrumentation.

All Surgical Holdings products undergo rigorous testing and inspection to applicable harmonised standards before leaving the factory. We offer CE marking on all Class I instrumentation, Class IIa and IIb implants, and can provide certificates of conformity for all materials used. Complete traceability throughout all aspects of the production process provides our customers with a fully documented quality control system.

All instrumentation carries a lifetime guarantee from the date of purchase on any fault found as a result of poor materials. This warranty is void, however, if repairs are carried out by anyone other than Surgical Holdings repair personnel, or if it is deemed to have been misused.

Please contact us or visit our website for current reprocessing instruction.



## Visit Us

We are always happy to invite visitors to come and see our strong family ethos in action at our Southend-on-Sea workshop.

We're in an excellent location for export customers, just 40 miles from London, at the mouth of the Thames Estuary.

**By road:** A13 or A127 to M25  
Dartford Tunnel and south coast ports

**By rail:** Direct links to London  
Liverpool Street, London Fenchurch Street & St Pancras International  
via Stratford

**By air:** International flights from Heathrow or Gatwick 90 minutes away, Stansted 60 minutes, and Southend airport is just 10 minutes away with direct flights to major cities across Europe



**Surgical Holdings, Parkside Centre,  
Temple Farm Industrial Estate,  
Southend-on-Sea, Essex, SS2 5SJ**

## How To Order

- 1 Choose your desired product from our extensive range or send your detailed tray list to us and we'll do the work.
- 2 Email [info@surgicalholdings.co.uk](mailto:info@surgicalholdings.co.uk) or call +44 (0)1702 602050 with the product codes and we will provide you with a quote.
- 3 Upon approval of the quote we will process your order.



**NEED A BESPOKE INSTRUMENT?**  
CONTACT OUR FRIENDLY TEAM TO DISCUSS YOUR REQUIREMENTS

## How To Pay

30 days credit is available (subject to status checks) or we accept Visa, Mastercard, Amex cards and cheque payments.

**30 DAYS CREDIT**



## Our Company History

Proud family heritage and an enduring commitment to quality



George's nephew **Fred Coole**, began his own ophthalmic business around 1940.

1910

Our story begins around 1910, when **George Poole\*** set up a successful business making high quality surgical instruments. George educated his two nephews in the fine art of surgical instrument crafting, and this was a passion that filtered its way through the family.



\*Unfortunately we don't have a photo of George available but we think he would have looked like this!

1940



Philip stays on as Chairman, while his son **Daniel Coole** takes the helm as Managing Director, having joined the business in 1995.

1988

Fred Coole passed his intricate skills on to his son **Philip Coole**, who in 1988 founded Surgical Holdings.



1995

Today Surgical Holdings is proud to be CE accredited for manufacture and supply of instruments and orthopaedic implants. We employ a focussed team of the highest-skilled surgical instrument technicians, selling finely-crafted instruments directly to both the NHS and private sector organisations.

2020

Each one of our close-knit team is treated as a valued family member. This is why we attract the best people, and why our team members stay with us for many years. Our customers benefit with unrivalled service, along with four generations of finely-honed expertise.



## Our Services

Instruments are repaired to BS 5194 where possible, OEM specification in accordance with the recommendations laid out in MHRA 'Managing Medical Devices,' ensuring CE marking remains valid.



### REPAIRED

High quality materials are used, providing full traceability as every part is recorded. Replacing instruments is avoided wherever possible.



### TESTED

Independent testing helps benchmark repairs against industry standards.



### UPCYCLED

If an instrument is not to our high standards or we can't repair it, we will replace it with a brand new one for the cost of a repair\*. This ensures continual upcycling of your trays.



### MARKED

Instruments can be laser marked, encoded and GS1 2D matrix marked at the same time as a repair.



### ACCREDITED

Repairs are ISO 13485 accredited.



### GUARANTEED

Customers receive an industry leading 18 month warranty as standard on all instrument repairs.



### INSURED

We carry full product, professional liability and transit insurance.



### DELIVERED

Standard turnaround times are 1 week, an express 2 day service is available.

+ Our instrument technicians carry out a minimum apprenticeship of 5 years and are trained to manufacture instruments rather than simply repair them. This gives us 360 degree understanding of the challenge and the importance of correctly functioning medical devices.

\*Applies to selected instruments only, please get in touch for full details.

## The Repair Process



Request a collection by contacting Surgical Holdings or by using the Surgifix Repair Portal



Complete paperwork, pack the decontaminated instruments and call Surgical Holdings to arrange a courier or sales representative collection



Quotation is raised



Provide purchase order details to Surgical Holdings



Instrument is repaired, polished, laser marked for traceability and passivated



Returned by courier within 7 days, with a repair report (for scopes and air tools)

Our expertise means that instruments can be modified or remanufactured if required. Customers can also receive training, participate in factory visits or simply call their local representative for guidance with instrumentation or management.

## Our Services

### Instrument and Power Tool Repair

We repair General Instruments, Laparoscopic and Electrosurgery Instruments

- Instruments are repaired by an experienced instrument 'maker', not just trained on repairs
- All market brands of leading Power, Battery and Pneumatic tools repaired
- Brand new parts with full traceability
- Full tracking of devices from handover to return through Surgifix
- Option for free personal pick up and delivery through our team



## Our Services

### Instrument Refurbishment

Refurbishing instruments can save up to **80%** of the cost of buying new, with compelling evidence to demonstrate effectiveness

Independent research<sup>1</sup> showed that instruments refurbished by Surgical Holdings had a 4x reduction in the amount of residual protein.

The smooth and polished surface has an increased cleaning efficacy, and all refurbishments come with an 18 month warranty as standard. Standard turnaround times are 1 week, and an express 2 day service available.



Reference: <sup>1</sup>Data available on file.

### Endoscope Repair

All major brands of rigid endoscope can be repaired at Surgical Holdings workshop in Southend-on-Sea. Using the latest optical technology, Surgical Holdings' highly skilled and experienced technicians will return scopes to the manufacturer's original specification. All parts are brand new and have full traceability. Surgical Holdings also manufacture their own fibre optic light bundles.



- 18 month guarantee on the repair
- OEM optical specification followed where possible
- Personal collection and delivery
- Laser welding for sheaths

- ISO 13485 accredited As recommended by MHRA\* advice around endoscope storage and care
- Free educational visits to our scope workshop and see all our repair facilities

+ We also repair the **Olympus ENDOEYE**



**Proactive Management of Endoscopes**  
Surgical Holdings can set up and manage a 'check and repair' service for rigid endoscopes. This ensures scopes are regularly checked, refurbished, repaired and maintained to a high standard. We will catalogue your scopes and create a maintenance schedule for you.

### Surgifix Repair Portal

An easy-to-use online system with up-to-date information on all your repairs

- ✓ The only company offering you the ability to manage and monitor your repairs online, with direct access to communicate with the repairs team
- ✓ View pricing, run reports and see the progress of repairs
- ✓ Instant notifications allow the repairs team to advise which of your instruments need a repair or refurbishment



**View pricing and create quotes**  
These can be printed or saved

**View historical endoscope repair reports**

**Receive instant automatic notifications**  
Allows the repair team to know what needs repairing and ultimately saves time and effort when managing repairs and refurbishments

**Run reports**

**View live progress of repairs**

SMART

If we can't repair your instrument, we'll replace it for the price of the repair

\*MHRA Managing Medical Devices - April 2016

## Case Study

### Surgical Instrument Set Refurbishment at North Devon District Hospital

Surgical Holdings have been recently managing a refurbishment programme for North Devon District Hospital. Here is their report on the implementation and success of their refurbishment programme so far.

#### Background

North Devon District Hospital is part of the Northern Devon Healthcare NHS Trust and the theatre complex has an inventory in excess of 1000 sets. The majority of sets are owned by the trust but this is supplemented with "Loan and Consignment" Orthopaedic sets.

#### Need for Change

With the need for clinical efficiency and productivity in the theatres instrumentation is required to be efficient and fit for purpose.

Limited sets are being used with a high turnover affecting compliance, sharpness, tension, etc. New instruments are available to replace old, well used stock but the capital required for the instrumentation is hard to obtain.

#### Implementation

To offset the need for capital to fund instrument replacements the CSSD and Theatres took the decision to try the Surgical Holdings option of refurbishing the instruments sets rather than disposing and purchasing new instruments. Instruments will either be refurbished back to new quality or replaced with new items for an inclusive price.

A "Basic" set was delivered to Surgical Holdings on the understanding the returned set would be assessed by the theatre staff to ensure the returned items met the requirements of the clinical team; e.g. sharpness, tension, colour, glare (lack of), etc.

The set passed the test and the remaining 22 "Basic" sets were refurbished on a rolling plan, the benefit of sending one set away at a time ensured a maximum stock level was available for clinical use.

Following the success of the 22 "Basic" sets a further 10 Oral Surgery Sets have been refurbished to the same standard.

Currently we have a Large Ortho Basic back after refurbishment awaiting theatre approval.

#### Implications

##### Finance

- No capital required to fund purchase
- Revenue spend to fund refurbishment

##### CSSD

- Minimum of sets out of service due to rolling programme
- Less incomplete sets as items are like new on refurbished sets, not needing further repairs

##### Theatre Staff

- Increased Clinical confidence – instruments like new
- Not subject to shortage of sets during process
- Reduction in procurement process – process agreed then rolling work plan
- Clinical staff sign-off regarding quality

## General Instruments

Artery Forceps	10
Clamps	13
Spring Forceps	14
Tissue Forceps	16
Sponge Holding and Sterilising Forceps	18
Other Forceps	19
Scissors	20
Needle Holders	25
Combined Scissor and Needle Holders	29
Bag and Towel Clips	30
Retractors	31
Dissectors and Probes	39
Miscellaneous	40
Hollow Ware	41
Silicone Matting	42
Wire Sterilising Baskets	42
Optical Fibre Cables	44



*The refurbishment of the theatre sets has allowed high usage instrumentation to be brought back up to a standard equal to new, this has been met with appreciation from theatre staff and has ensured clinical requirement for sets has not been compromised.*

Fraser Bishop, Facilities Clinical Services Manager Trust Decontamination Lead, North Devon District Hospital

# Artery Forceps

## Adson Artery Forceps

Box joint, 180mm long

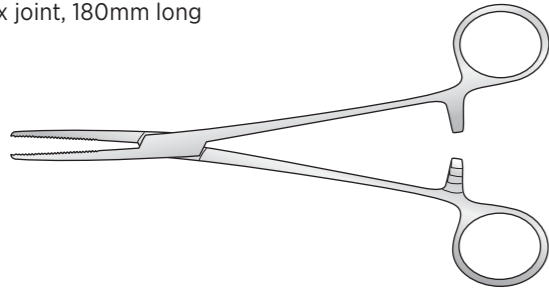

Serrated jaws		1-2 teeth	
Code	Description	Code	Description
SC-GI/034	Straight	SC-GI/034b	Straight
SC-GI/034a	Curved	SC-GI/034c	Curved

## Cairns Artery Forceps

Box joint, half serrated jaws  
145mm long

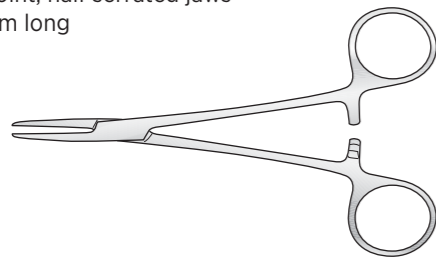

Serrated jaws		1-2 teeth	
Code	Description	Code	Description
SC-GI/415	Straight	SC-GI/020	Curved
		SC-GI/021	Curved to side

## Crile Artery Forceps

Box joint, serrated jaws

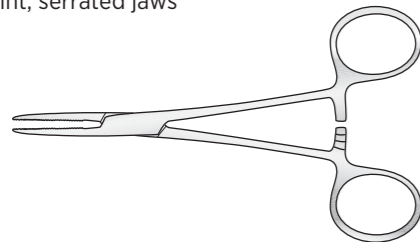

Straight		Curved	
Code	Description	Code	Description
SC-GI/014	140mm long	SC-GI/015	140mm long
SC-GI/014a	160mm long	SC-GI/015a	160mm long

## Cushing Artery Forceps

Box joint, fine, half serrated jaws, 140mm long

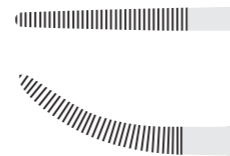
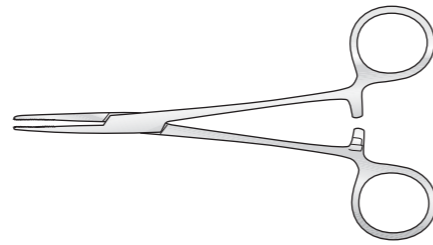

Code	Description
SC-GI/001	Straight
SC-GI/002	Curved

## Dunhill Artery Forceps

Box joint, fine serrations

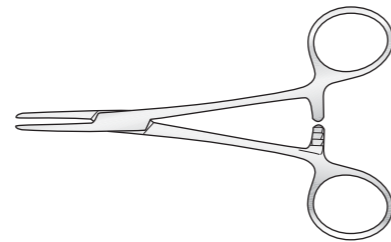

Straight		Curved	
Code	Description	Code	Description
SC-GI/065	135mm long	SC-GI/043	135mm long
SC-GI/065a	190mm long	SC-GI/468	180mm long

## Lawson Tait Artery Forcep

Box joint, straight jaw

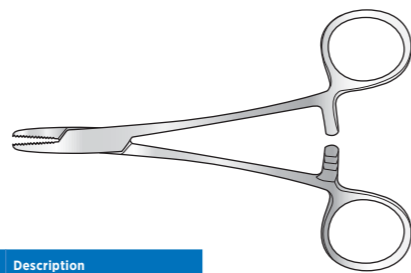

Code	Description
SC-GI/SH5924	140mm long

## Halstead Mosquito Forceps

Standard pattern, haemostatic, box joint

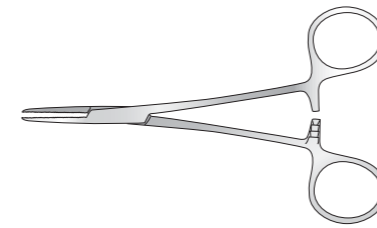

Serrated jaw		Micro, 100mm long	
Code	Description	Code	Description
SC-GI/007	Straight 125mm long	SC-GI/003	Straight, serrated
SC-GI/008	Curved 125mm long	SC-GI/004	Curved, serrated
SC-GI/009	Fully curved 125mm long	SC-GI/005	Straight, 1-2 teeth
		SC-GI/006	Curved, 1-2 teeth

1-2 teeth	
Code	Description
SC-GI/010	Straight 125mm long
SC-GI/012	Straight 190mm long
SC-GI/011	Curved 125mm long
SC-GI/013	Curved 190mm long

## Heiss Artery Forceps

Box joint, 205mm long

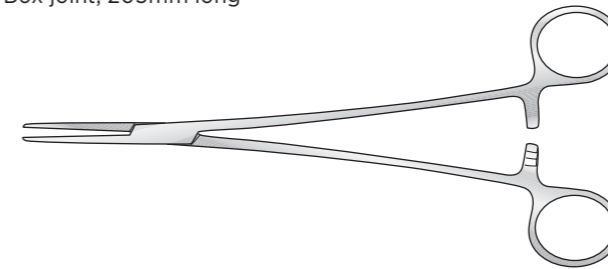

Serrated jaws		1-2 teeth	
Code	Description	Code	Description
SC-GI/016	Straight	SC-GI/016a	Straight
SC-GI/017	Curved	SC-GI/017b	Curved

# Artery Forceps

## Kelly Artery Forceps

Box joint, half serrated jaws



Straight		Curved	
Code	Description	Code	Description
SC-GI/022	140mm long	SC-GI/024	140mm long
SC-GI/023	160mm long	SC-GI/025	160mm long

## Fraser Kelly Artery Forceps Curved

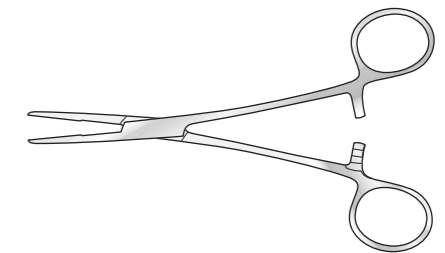

Straight	
Code	Description
SC-GI/468a	180mm

## Kocher Artery Forceps

Box joint, 1-2 teeth

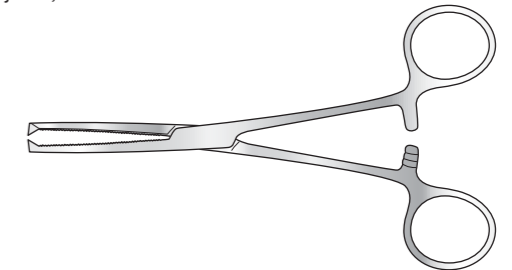

Straight		Curved	
Code	Description	Code	Description
SC-GI/052	130mm long	SC-GI/057	150mm long
SC-GI/053	150mm long	SC-GI/058	180mm long
SC-GI/054	180mm long	SC-GI/059	200mm long
SC-GI/055	200mm long	SC-GI/060	230mm long
SC-GI/056	230mm long		

## Moynihan Artery Forceps

Box joint, half-serrated jaws

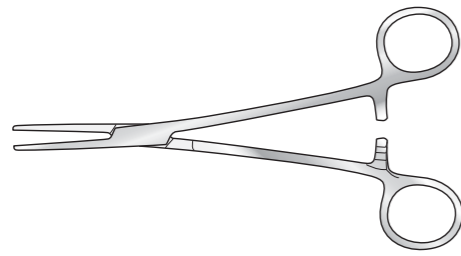

### Straight

Code	Description
SC-GI/018	145mm long
SC-GI/068	180mm long

### Curved

Code	Description
SC-GI/019	145mm long
SC-GI/069	180mm long

## Rochester-Pean Artery Forceps

Box joint

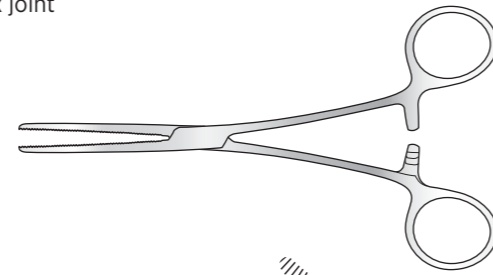

### Straight

Code	Description
SC-GI/044	165mm long
SC-GI/045	190mm long
SC-GI/046	205mm long
SC-GI/047	240mm long

### Curved

Code	Description
SC-GI/048	165mm long
SC-GI/049	180mm long
SC-GI/050	205mm long
SC-GI/051	240mm long

## Roberts Artery Forceps

Screw joint, curved on flat, serrated

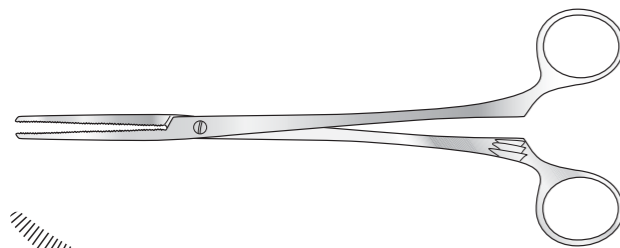

Code	Description
SC-GI/070	230mm long

## Spencer Wells Artery Forceps

Box joint, serrated jaws

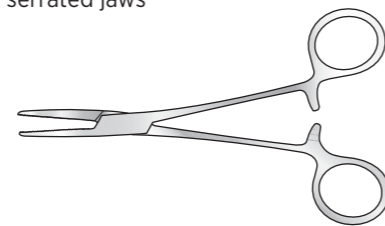

### Straight

Code	Description
SC-GI/035	127mm long
SC-GI/036	152mm long
SC-GI/037	177mm long
SC-GI/038	203mm long

### Curved

Code	Description
SC-GI/039	127mm long
SC-GI/040	152mm long
SC-GI/041	177mm long
SC-GI/042	203mm long

OTHER SIZES AVAILABLE

## Dandy Artery Forceps

Box joint, curved in plane

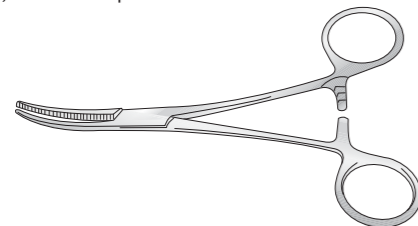

Code	Description
SC-GI/076	140mm long

## Carmalt Angiotribe Forceps

Box joint, atraumatic, light pattern

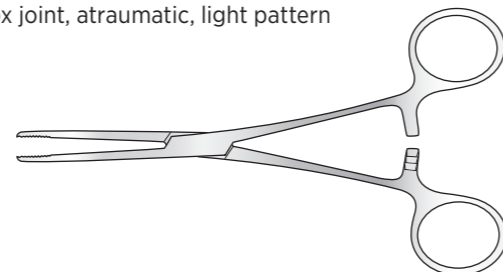

### Straight

Code	Description
SC-GI/062	165mm long
SC-GI/063	200mm long
SC-GI/064	230mm long

### Curved

Code	Description
SC-GI/061	165mm long

## Dieffenbach Bulldog Clamp

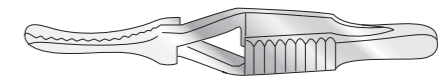
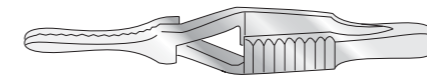

### Straight, serrated

Code	Description
SC-GI/112	1.2mm fine jaw, 40mm long
SC-GI/113	1.2mm fine jaw, 45mm long
SC-GI/108	1.8mm jaw, 30mm long
SC-GI/109	1.8mm jaw, 35mm long
SC-GI/110	2.5mm jaw, 40mm long
SC-GI/111	2.5mm jaw, 45mm long
SC-GI/107	6mm heavy jaw, 60mm long
SC-GI/455	20mm jaw, 75mm long
SC-GI/455a	30mm jaw, 85mm long
SC-GI/455b	45mm jaw, 105mm long
SC-GI/455c	65mm jaw, 120mm long

### Straight, plain

Code	Description
SC-GI/129	1.2mm fine jaw, 40mm long
SC-GI/131	1.2mm fine jaw, 45mm long
SC-GI/121	1.8mm jaw, 30mm long
SC-GI/123	1.8mm jaw, 35mm long
SC-GI/125	2.5mm jaw, 40mm long
SC-GI/127	2.5mm jaw, 45mm long

### Curved, serrated

Code	Description
SC-GI/119	1.2mm fine jaw, 40mm long
SC-GI/120	1.2mm fine jaw, 45mm long
SC-GI/115	1.8mm jaw, 30mm long
SC-GI/116	1.8mm jaw, 35mm long
SC-GI/117	2.5mm jaw, 40mm long
SC-GI/118	2.5mm jaw, 45mm long
SC-GI/114	6mm heavy jaw, 60mm long
SC-GI/456	20mm jaw, 75mm long
SC-GI/456a	30mm jaw, 85mm long
SC-GI/456b	45mm jaw, 105mm long
SC-GI/456c	65mm jaw, 120mm long

### Curved, plain

Code	Description
SC-GI/130	1.2mm fine jaw, 40mm long
SC-GI/132	1.2mm fine jaw, 45mm long
SC-GI/122	1.8mm jaw, 30mm long
SC-GI/124	1.8mm jaw, 35mm long
SC-GI/126	2.5mm jaw, 40mm long
SC-GI/128	2.5mm jaw, 45mm long

## Blalock Bulldog Clamp

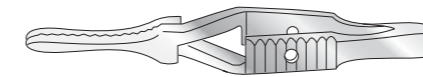

### Serrated, with hole in handle

#### Straight

Code	Description
SC-GI/480	11mm jaw, 38mm long
SC-GI/482	14mm jaw, 48mm long
SC-GI/493	17mm jaw, 60mm long
SC-GI/481	27mm jaw, 70mm long

#### Curved

Code	Description
SC-GI/478	11mm jaw, 38mm long
SC-GI/479	14mm jaw, 48mm long
SC-GI/491	17mm jaw, 60mm long
SC-GI/492	27mm jaw, 70mm long

### Plain, with hole in handle

#### Straight

Code	Description
SC-GI/486	11mm jaw, 38mm long
SC-GI/487	14mm jaw, 48mm long
SC-GI/488	17mm jaw, 60mm long
SC-GI/489	27mm jaw, 70mm long

#### Curved

Code	Description
SC-GI/483	11mm jaw, 38mm long
SC-GI/484	14mm jaw, 48mm long
SC-GI/485	17mm jaw, 60mm long
SC-GI/490	27mm jaw, 70mm long

## An Overview On

# Forcep Jaw Types

You will see that forceps in our catalogue will have either a traditional serrated jaw or a different design which is known as atraumatic (or non-traumatic).

### Traditional Serrated Jaw



The traditional serrated jaw is generally more robust and used on forceps where the areas are not as delicate.

### Atraumatic Jaw



Atraumatic jaws will be mainly found in delicate surgery areas such as vascular and cardiothoracic. The design is such, that the surface area gripped is reduced, ensuring less trauma without the loss of grip.

# Spring Forceps

## Adsons Dissecting Forceps

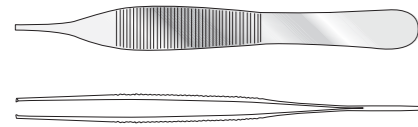

127mm long

Code	Description
SC-GI/257	1-2 teeth
SC-GI/258	Lightweight, micro
SC-GI/259	Serrated
SC-GI/260	Serrated, lightweight, micro

## Block End Dissecting Forceps

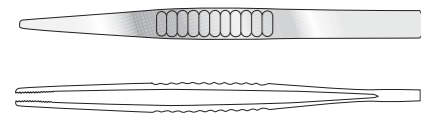

Serrated

Code	Description
SC-GI/255	127mm long
SC-GI/256	152mm long
SC-GI/256a	203mm long

## Bonney Dissecting Forceps

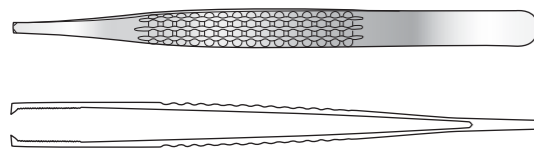

178mm long

Code	Description
SC-GI/267	Serrated, 1-2 teeth
SC-GI/268	1-2 teeth

## Charnley-McIndoe Dissecting Forceps

150mm long

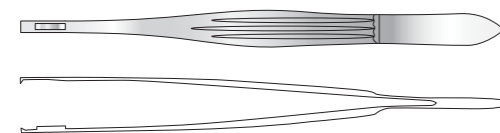

Code	Description
SC-OR/N045a	2-3 teeth

## DeBakey Atraumatic Dissecting Forceps

Straight, atraumatic jaws

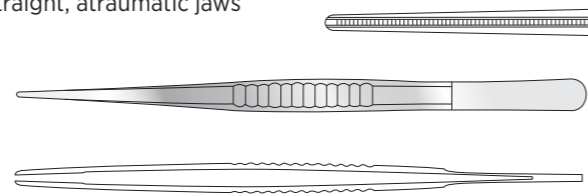

1.5mm

Code	Description
SC-GI/238a	150mm long
SC-GI/240a	240mm long

2.5mm

Code	Description
SC-GI/238b	150mm long
SC-GI/240b	240mm long

2mm

Code	Description
SC-GI/238	150mm long
SC-GI/241	180mm long

2.8mm

Code	Description
SC-GI/238c	150mm long
SC-GI/240c	240mm long
SC-GI/241c	180mm long

## Dissecting Forceps

Turnover end, serrated jaws

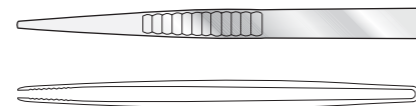

Code	Description
SC-GI/242	127mm long
SC-GI/243	152mm long

Code	Description
SC-GI/244	178mm long
SC-GI/245	203mm long

## Dunhill Dissecting Forceps

Light, fine serrated jaws



Code	Description
SC-GI/457	145mm long

## Fredrick Coole Dissecting Forceps

Extra fine serrated jaws

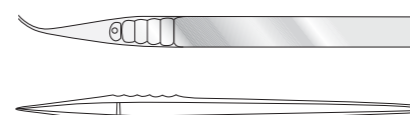

125mm long

Code	Description
SC-GI/066	Straight
SC-GI/067	Curved

## Gillies Dissecting Forceps

1-2 teeth

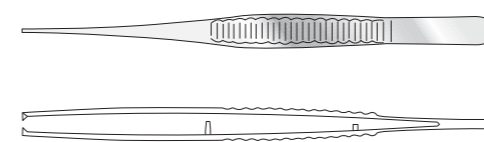

Code	Description
SC-PL/052	152mm long

## Jackson Burrows Dissecting Forceps

140mm long

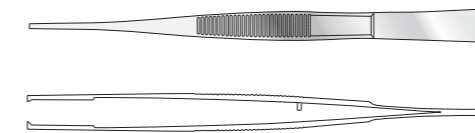

Code	Description
SC-OR/N037	Tongue and groove, 1-2 teeth
SC-OR/N037a	Tongue and groove only

## Jean Dissecting Forceps

Serrated jaws, 140mm long

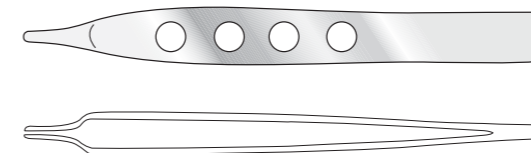

Code	Description
SC-GI/269	Fine
SC-GI/270	1-2 teeth
SC-GI/271	2-3 teeth, 178mm long

## Lanes Dissecting Forceps

1-2 teeth on serrated jaws, 140mm long

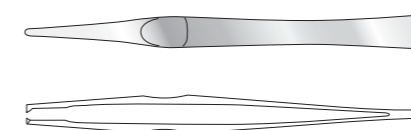

Code	Description
SC-GI/246	127mm long
SC-GI/247	152mm long
SC-GI/248	178mm long

Code	Description
SC-GI/249	2-3 teeth, 178mm long
SC-GI/250	2-3 teeth 203mm long

## McIndoe Dissecting Forceps

152mm long

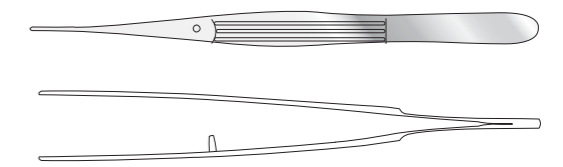

Code	Description
SC-GI/476	Serrated
SC-GI/477	1-2 teeth

## McIndoe Modified Dissecting Forceps

152mm long, 1mm tip, modified for fine powerful dissection with strong action tip

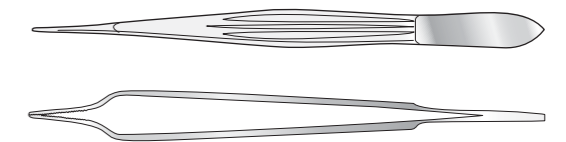

Code	Description
SH/5961	Serrated

## Treves Dissecting Forceps

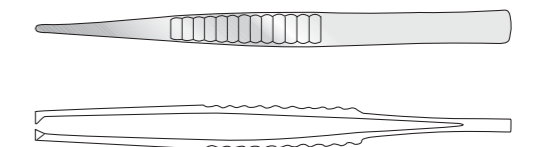

1-2 teeth

Code	Description
SC-GI/251	127mm long
SC-GI/252	152mm long

2-3 teeth

Code	Description
SC-GI/253	127mm long
SC-GI/254	152mm long

## Waugh Dissecting Forceps

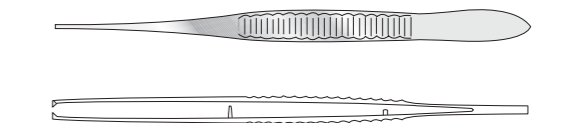

Fine, serrated

Code	Description
SC-GI/261	152mm long
SC-GI/262	178mm long
SC-GI/263	203mm long

Fine, 1-2 teeth

Code	Description
SC-GI/264	152mm long
SC-GI/265	178mm long
SC-GI/266	203mm long

# Spring Forceps



## Allis Tissue Forceps

Box joint

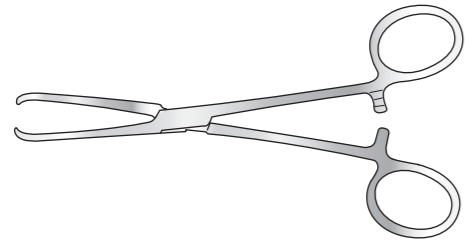

150mm long

Code	Description
SC-GI/272	3-4 teeth
SC-GI/273	4-5 teeth

190mm long

Code	Description
SC-GI/414	5-6 teeth

## Duval Tissue Forceps

Box joint

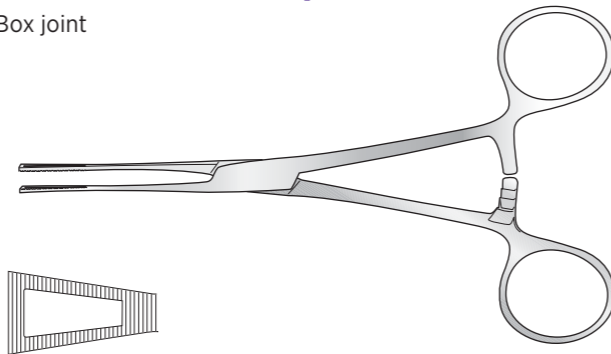

Code	Description
SC-GI/279	13mm wide, 203mm long

## Shaw Tissue Forceps

Box joint

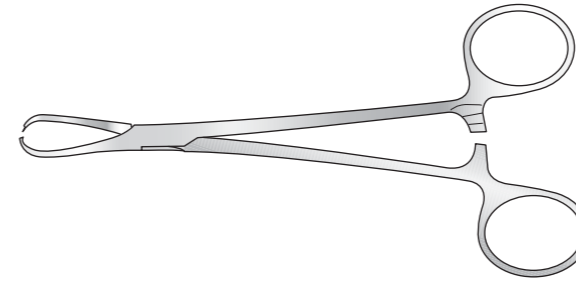

Code	Description
SC-GI/458	1-2 teeth, 178mm long

## Littlewood Tissue Forceps

Box joint, 2-3 teeth

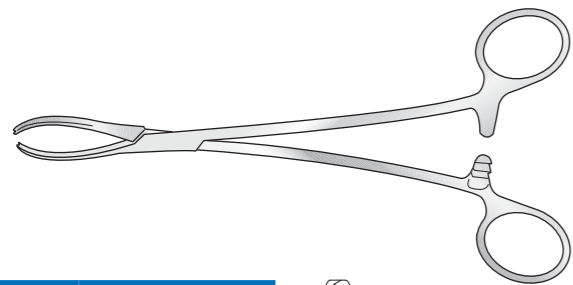

Code	Description
SC-GI/275	190mm long

## Lane Tissue Forceps

Box joint, 1-2 teeth, fenestrated

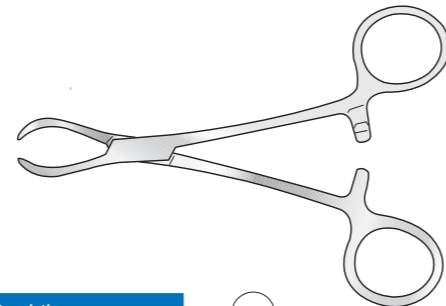

Code	Description
SC-GI/280	127mm long
SC-GI/281	152mm long
SC-GI/282	197mm long

## Babcock Tissue Forceps

Box joint, serrated jaws

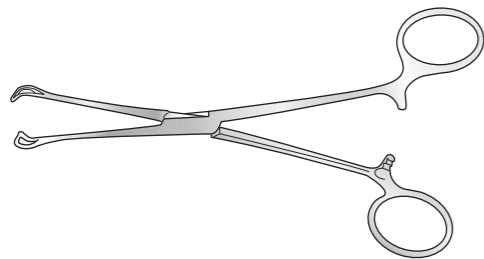

Code	Description
SC-GI/276	160mm long
SC-GI/277	200mm long
SC-GI/278	230mm long

## Rutherford Morrison Tissue Forceps

Box joint

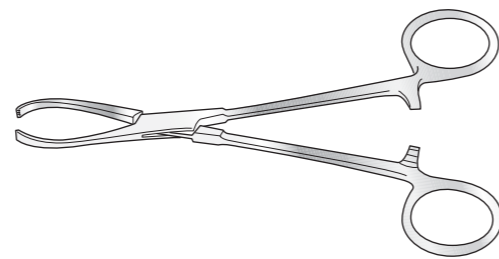

Code	Description
SC-GI/283	4-5 teeth, 152mm long

## Guys Gallabin Suture-Holding Forceps

Screw joint, angled flat blades

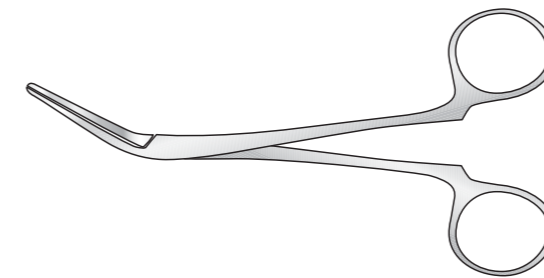

Code	Description
SC-GI/450	125mm long
SC-GI/4402	150mm long

## Russian Dissecting Forceps

With fenestrated end

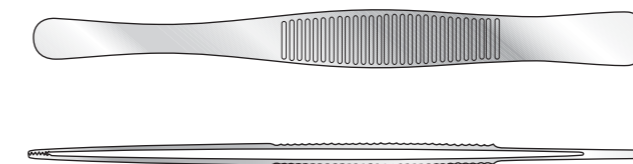

Code	Description
SC-GI/SH-5503b	150mm long
SC-GI/SH-5503	200mm long
SC-GI/403	230mm long
SC-GI/SH-5503a	250mm long

## Special Offer

on SSD Essentials Pack

Top up your trays with these essentials...

CONTACT US FOR OUR OFFER PRICE

### Halstead Mosquito Forceps

Straight/Curved  
125mm (5")

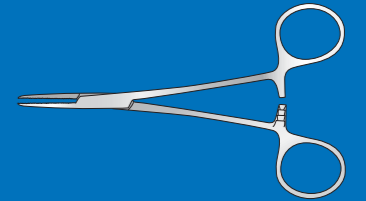

### Ramsey Sponge Holding Forceps

Straight, Serrated  
Jaws 241mm  
(9½")

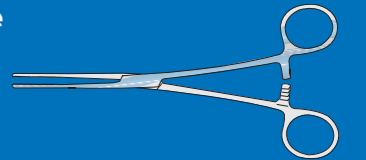

### Scalpel Blade Handle

No. 3



### Spring Clip

Serrated Pattern,  
Stainless Steel for  
Fixing Slings to Leg  
Splints, also for  
Towel Clipping  
6.3cm (2½") Wide

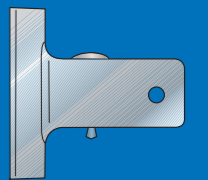

### Spencer Wells Artery Forceps

Straight, Serrated  
Jaws

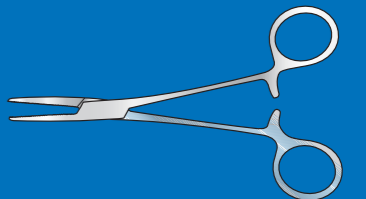

Email us to place your order

[info@surgicalholdings.co.uk](mailto:info@surgicalholdings.co.uk)

# Sponge Holding and Sterilising Forceps

## Rampley Sponge Holding Forceps

Box joint, straight, serrated jaws

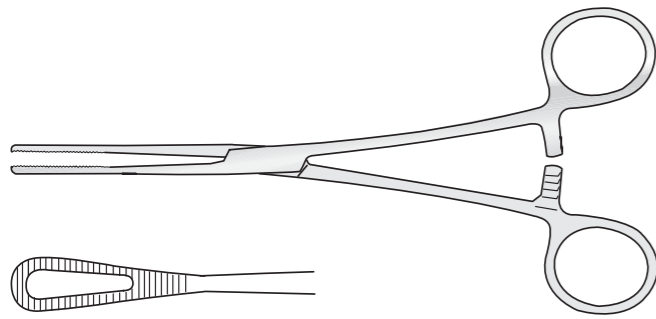

Code	Description
SC-GI/353	178mm long
SC-GI/354	241mm long

## Lister Sinus Forceps

Box joint, serrated tip

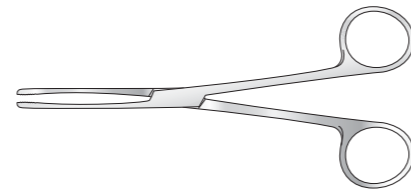

Code	Description
SC-GI/367	127mm long
SC-GI/368	152mm long
SC-GI/369	178mm long

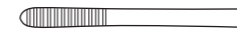

## Foerster Sponge Holding Forceps

Box joint, straight, serrated jaws

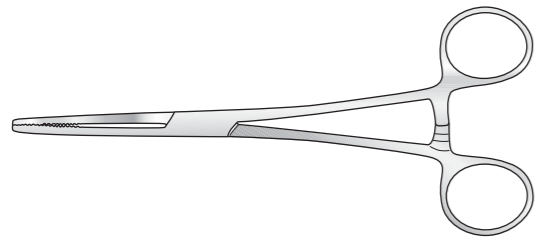

Code	Description
SC-GI/354a	178mm long

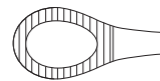

## Cheatele Sterilizer Forceps

Screw joint

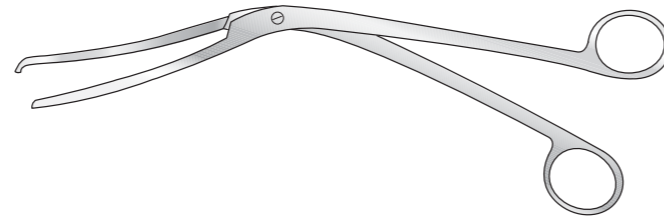

Code	Description
SC-GI/364	267mm long

## Harrison Bowl Steriliser Forceps

Screw joint, angled, double jaw

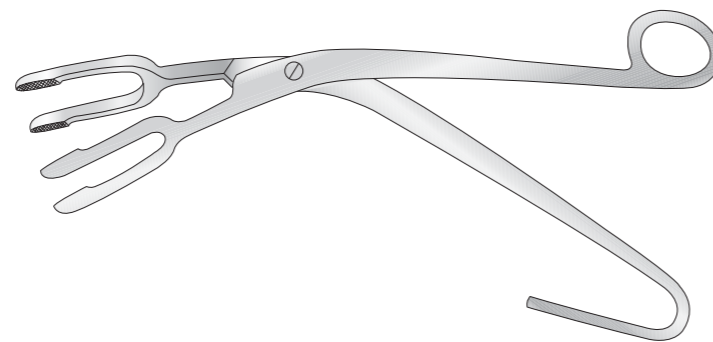

Code	Description
SC-GI/365	356mm long
SC-GI/366	457mm long

# Other Forceps

## Hunter Splinter Forceps

Serrated grooved pointed jaws



Code	Description
SC-GI/360	115mm long

## Michel Forceps

Box joint, double-ended, for inserting and removing clips stainless steel

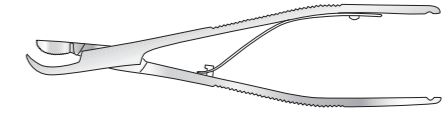

Code	Description
SC-GI/357	130mm long

## Michel Skin Holding Forceps

With magazine for Michel clips

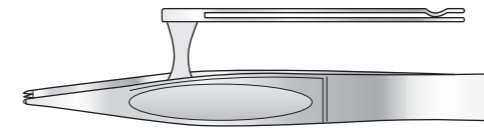

Code	Description
SC-GI/358	1-2 teeth, 127mm long

## Michel Clip Extracting Forceps

Box joint

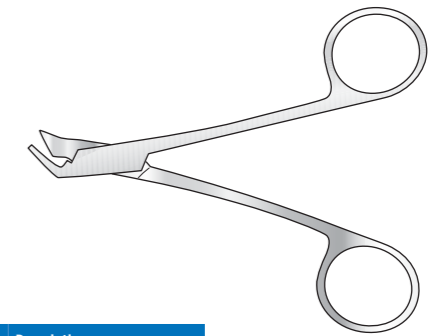

Code	Description
SC-GI/359	125mm long

## Childe Approximating Forceps

With magazine for Michel clips

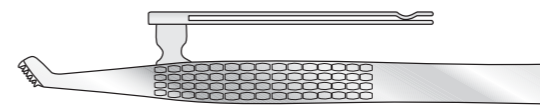

Code	Description
SC-GI/469	180mm long

## Robins Anchoring Forceps

140mm long

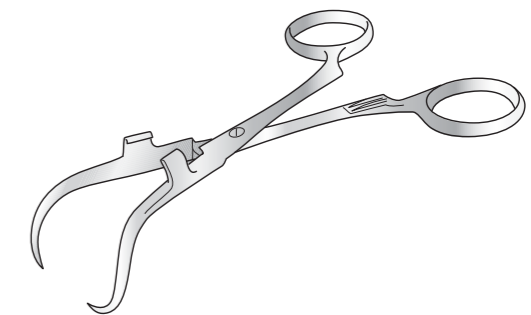

Code	Description
SC-GI/453	5mm with holder for diathermy leads
SC-GI/453a	13mm with holder for suction tubing

# Premium Quality Stainless Steel Scissors

FOR INFORMATION ON BLACK AND GOLD BOWS SEE PAGE 23

# Scissors

## Dressing Scissors



### Blunt/Blunt

#### Straight

Code	Description
SC-GI/133	130mm long
SC-GI/136	146mm long
SC-GI/139	165mm long

#### Curved

Code	Description
SC-GI/142	130mm long
SC-GI/143	146mm long
SC-GI/144	165mm long
SC-GI/145	185mm long
SC-GI/404	147mm long

With one serrated blade

### Blunt/Sharp

#### Straight

Code	Description
SC-GI/134	130mm long
SC-GI/137	146mm long
SC-GI/140	165mm long

### Sharp/Sharp

#### Straight

Code	Description
SC-GI/135	130mm long
SC-GI/138	146mm long
SC-GI/141	165mm long

#### Curved

Code	Description
SC-GI/146	130mm long

## Dressing Scissors, Left-Handed

With one black bow, 145mm long

### Blunt/Blunt

Code	Description
SC-GI/192	Straight
SC-GI/193	Curved

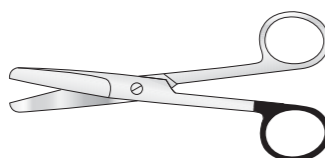

### Blunt/Sharp

Code	Description
SC-GI/194	Straight
SC-GI/195	Curved

### Sharp/Sharp

Code	Description
SC-GI/196	Straight
SC-GI/197	Curved

## Little Dissecting Scissors

Fine pattern, with eye for suture

Code	Description
SC-PL/001f	115mm long

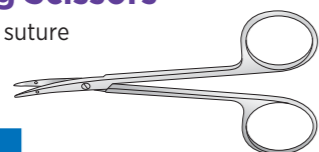

## Kilner Dissecting Scissors

Fine pattern

Code	Description
SC-PL/001a	115mm long



## Metzenbaum Scissors

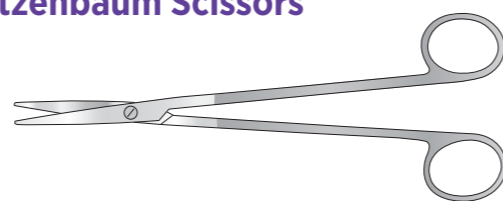

### Straight

Code	Description
SC-GI/405	180mm long
SC-GI/406	147mm long
SC-GI/406a	200mm long
SC-GI/406b	230mm long
SC-GI/406c	250mm long
SC-GI/406d	280mm long

### Curved

Code	Description
SC-GI/407	185mm long
SC-GI/408	147mm long
SC-GI/408a	200mm long
SC-GI/408b	230mm long
SC-GI/408c	250mm long
SC-GI/408d	280mm long

## Mayo Scissors



### Straight

Code	Description
SC-GI/409	140mm long
SC-GI/409a	160mm long
SC-GI/411	190mm long
SC-GI/411a	230mm long

### Curved

Code	Description
SC-GI/410	140mm long
SC-GI/410a	160mm long
SC-GI/412	190mm long
SC-GI/412a	230mm long

## Fergusson Scissors

Angled on flat

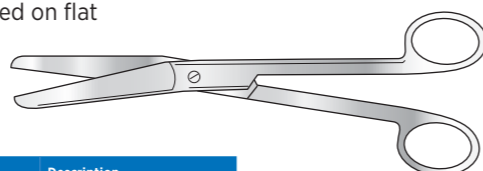

Code	Description
SC-GI/148	180mm long

## Paynes Suture Scissors

Code	Description
SC-GI/152	100mm long

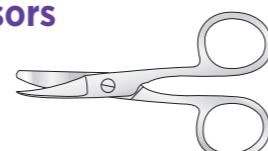

## Ligature Stitch Scissors

Fine pattern

Code	Description
SC-GI/153	115mm long

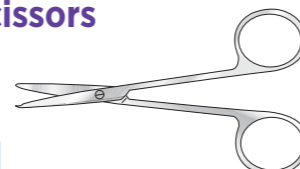

## Lister Bandage Scissors

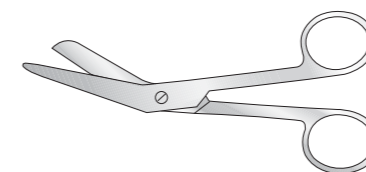

Code	Description
SC-GI/154	147mm long
SC-GI/155	178mm long

## McIndoe Scissors

178mm long

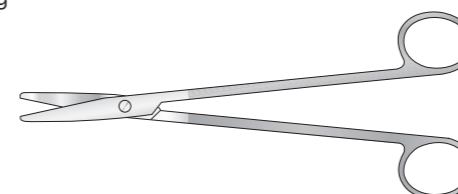

Code	Description
SC-GI/149	Straight
SC-GI/150	Curved on flat
SC-GI/150sc	Supercut, curved



## Heath Stitch Scissors

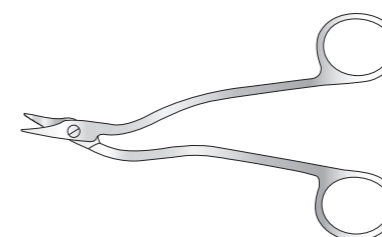

Code	Description
SC-GI/151	152mm long

## Tubing Scissors

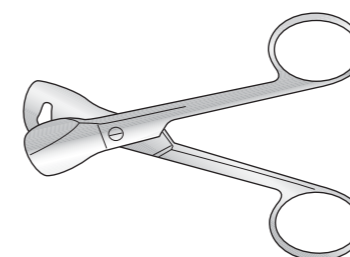

Code	Description
SC-GI/147	130mm long

## Lister Bandage Scissors

Angled, with probe end

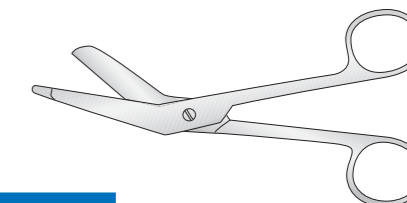

Code	Description
SC-GI/361	147mm long
SC-GI/362	178mm long

## Thomas Strabismus Scissors

114mm long

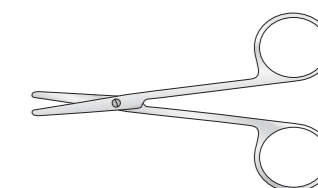

Code	Description
SC-OP/030	Straight
SC-OP/029	Curved

## "Careless" Scissors

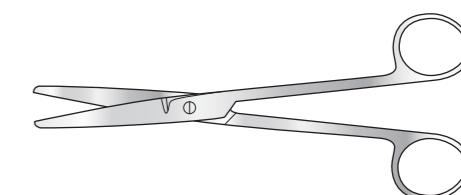

Code	Description
SC-GI/474	165mm long

## Utility Scissors



Code	Description
SC-GI/466	190mm long

# Tungsten Carbide Hard Insert Scissors

## Dressing Scissors

Tungsten carbide hard insert, blunt/blunt

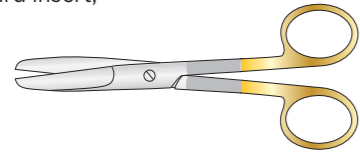

Straight		Curved	
Code	Description	Code	Description
SC-GI/430	130mm long	SC-GI/431	130mm long
SC-GI/432	145mm long	SC-GI/433	145mm long
SC-GI/434	165mm long	SC-GI/435	165mm long
SC-GI/436	185mm long		

## Mayo Dressing Scissors

Tungsten carbide hard insert

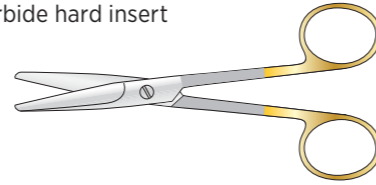

Straight		Curved	
Code	Description	Code	Description
SC-GI/419	140mm long	SC-GI/420	140mm long
SC-GI/419a	160mm long	SC-GI/420a	160mm long
SC-GI/421	190mm long	SC-GI/422	190mm long
SC-GI/421a	230mm long	SC-GI/422a	230mm long

## Dressing Scissors

Tungsten carbide hard insert, blunt/sharp

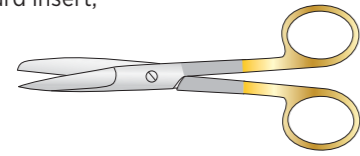

Straight		Curved	
Code	Description	Code	Description
SC-GI/423	130mm long	SC-GI/424	130mm long
SC-GI/425	145mm long	SC-GI/426	145mm long
SC-GI/427	165mm long	SC-GI/428	165mm long
SC-GI/429	185mm long		

## Mayo-Harrington Dressing Scissors

Tungsten carbide hard insert

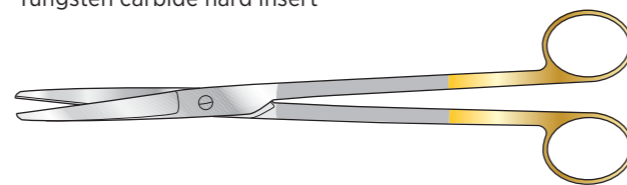

230mm long		200mm long	
Code	Description	Code	Description
SC-GI/417	Straight	SC-GI/162a	Straight
SC-GI/418	Curved	SC-GI/413b	Curved

## Dressing Scissors

Tungsten carbide hard insert sharp/sharp

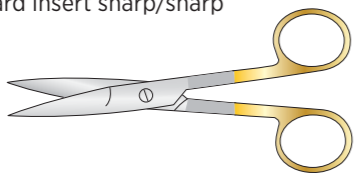

Straight		Curved	
Code	Description	Code	Description
SC-GI/437	130mm long	SC-GI/438	130mm long
SC-GI/439	145mm long	SC-GI/440	145mm long
SC-GI/441	165mm long	SC-GI/442	165mm long
SC-GI/443	185mm long		

## Metzenbaum Scissors

Tungsten carbide hard insert

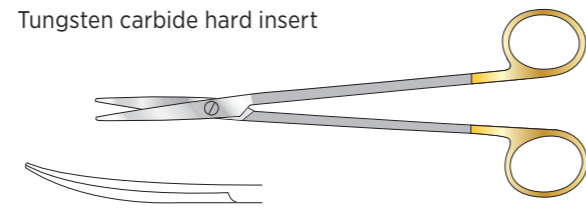

230mm long		200mm long	
Code	Description	Code	Description
SC-GI/445	145mm long	SC-GI/446	145mm long
SC-GI/448	185mm long	SC-GI/449	185mm long
SC-GI/471a	230mm long	SC-GI/449a	200mm long
SC-GI/471b	250mm long	SC-GI/449b	230mm long
SC-GI/471c	280mm long	SC-GI/449c	250mm long
		SC-GI/449d	280mm long

## Baby Metzenbaum Scissors

Tungsten carbide, hard insert, 145mm long

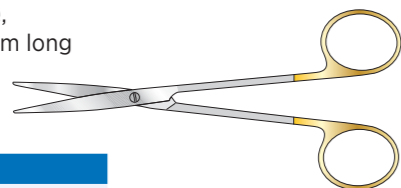

Code	Description
SC-GI/445a	Straight
SC-GI/446a	Curved

## Ligature Scissors

Tungsten carbide hard insert, curved

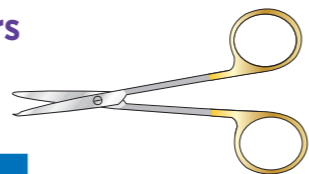

Code	Description
SC-GI/444	145mm long
SC-GI/447	185mm long

# Tungsten Carbide Supercut Scissors

## Mayo Harrington Scissors

Supercut, tungsten carbide

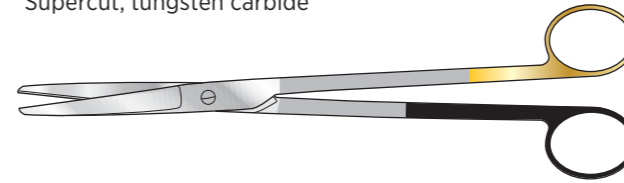

230mm long		200mm long	
Code	Description	Code	Description
SC-GI/162	Straight	SC-GI/162b	Straight
SC-GI/413	Curved	SC-GI/413b	Curved

## Mayo Scissors

Supercut, tungsten carbide

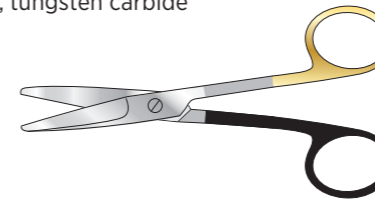

Straight		Curved	
Code	Description	Code	Description
SC-GI/163	140mm long	SC-GI/164	140mm long
SC-GI/163a	160mm long	SC-GI/164a	160mm long
SC-GI/165	190mm long	SC-GI/166	190mm long
SC-GI/165a	230mm long	SC-GI/166a	230mm long

## Metzenbaum Dissecting Scissors

Supercut, tungsten carbide

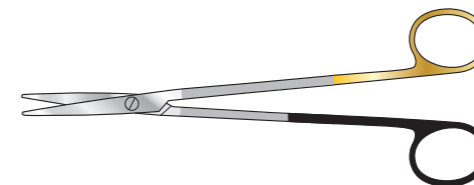

Straight		Curved	
Code	Description	Code	Description
SC-GI/188tc	185mm long	SC-GI/191tc	147mm
SC-GI/188tca	200mm long	SC-GI/189tc	185mm
SC-GI/188tcb	230mm long	SC-GI/186tca	200mm
SC-GI/188tcc	250mm long	SC-GI/188tcb	230mm
SC-GI/188tcd	280mm long	SC-GI/188tcc	250mm
		SC-GI/188tcd	280mm

## Dressing Scissors

Supercut, tungsten carbide

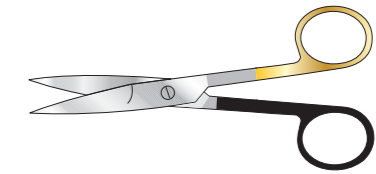

Blunt/Blunt		Curved	
Straight		Curved	
Code	Description	Code	Description
SC-GI/174	130mm long	SC-GI/175	130mm long
SC-GI/176	145mm long	SC-GI/177	145mm long
SC-GI/178	165mm long	SC-GI/179	165mm long
SC-GI/180	185mm long	SC-GI/180a	185mm long

## Blunt/Sharp

Straight		Curved	
Code	Description	Code	Description
SC-GI/167	130mm long	SC-GI/168	130mm long
SC-GI/169	145mm long	SC-GI/170	145mm long
SC-GI/171	165mm long	SC-GI/172	165mm long
SC-GI/173	185mm long	SC-GI/173a	185mm long

## Sharp/Sharp

Straight		Curved	
Code	Description	Code	Description
SC-GI/181	130mm long	SC-GI/182	130mm long
SC-GI/183	145mm long	SC-GI/184	145mm long
SC-GI/185	165mm long	SC-GI/186	165mm long
SC-GI/187	185mm long	SC-GI/187a	185mm long

## Guide for Gold and Black Bows

It's important to know the difference for the intended use of each scissor:

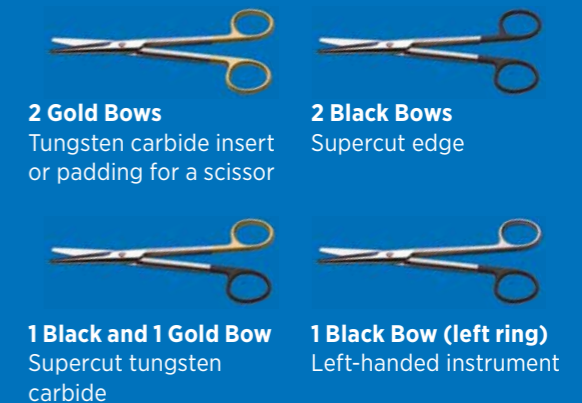

**2 Gold Bows**  
Tungsten carbide insert or padding for a scissor

**2 Black Bows**  
Supercut edge

**1 Black and 1 Gold Bow**  
Supercut tungsten carbide

**1 Black Bow (left ring)**  
Left-handed instrument carbide

# Supercut Operating Scissors

**i** WITH TWO BLACK BOWS FOR IDENTIFICATION

## Dressing Scissors

Supercut, blunt/blunt



145mm long

Code	Description
SC-GI/160	Straight
SC-GI/161	Curved

## Dressing Scissors

Supercut, blunt/sharp

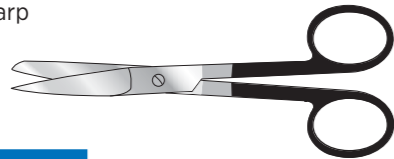

145mm long

Code	Description
SC-GI/156	Straight
SC-GI/157	Curved

## Dressing Scissors

Supercut, sharp/sharp

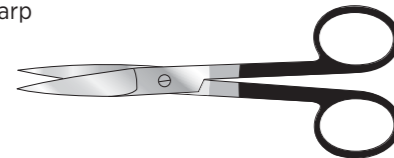

145mm long

Code	Description
SC-GI/158	Straight
SC-GI/159	Curved

## Mayo Scissors

Supercut



Straight

Code	Description
SC-GI/166a	140mm long
SC-GI/166e	160mm long
SC-GI/166b	170mm long

Curved

Code	Description
SC-GI/166c	140mm long
SC-GI/166f	160mm long
SC-GI/166d	170mm long

## Boyd Scissors

Supercut, blunt/blunt

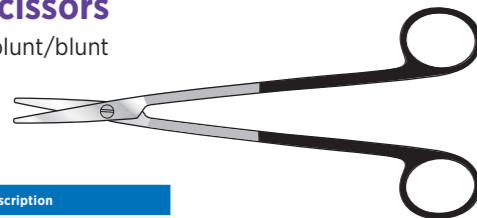

Code	Description
SC-THO/047	180mm long

## Metzenbaum Dissecting Scissors

Supercut

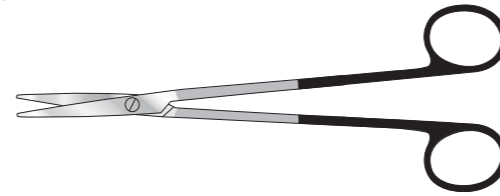

Straight (length)

Code	Description
SC-GI/190	147mm
SC-GI/188	185mm
SC-GI/188a	200mm
SC-GI/188b	230mm
SC-GI/188c	250mm
SC-GI/188d	280mm

Curved (length)

Code	Description
SC-GI/191	147mm
SC-GI/189	185mm
SC-GI/186a	200mm
SC-GI/186b	230mm
SC-GI/186c	250mm
SC-GI/186d	280mm

## Stevens Tenotomy Scissors

Supercut



Curved/blunt

Code	Description
SC-OP/424	114mm long
SC-OP/424a	125mm long
SC-OP/424gb	135mm long

Curved/sharp

Code	Description
SC-OP/425	114mm long
SC-OP/425a	140mm long
SC-OP/425b	160mm long

Code

Code	Description
SC-OP/426	Straight/blunt, 114mm long
SC-OP/427	Straight/sharp, 114mm long
SC-OP/427c	Straight/sharp, 180mm long

With cutout, 110mm long

Code	Description
SC-OP/427a	Straight/blunt
SC-OP/427b	Curved/blunt

## Strabismus Scissors

Supercut

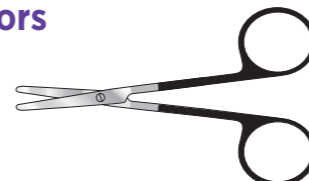

114mm long

Code	Description
SC-GI/475	Straight
SC-GI/475a	Curved

## Iris Scissors

Supercut



114mm long

Code	Description
SC-OP/476	Straight
SC-OP/476a	Curved

## Bruce Clarke Needle Holder

Screw joint

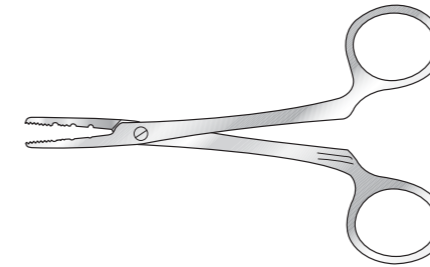

Code	Description
SC-GI/205	127mm long

## Crile-Wood Needle Holder

Straight, baby, fine

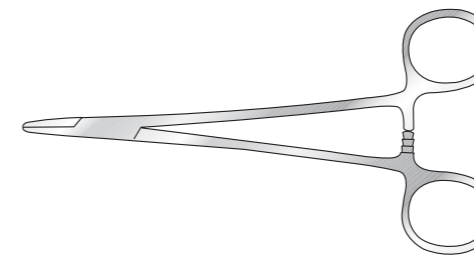

Code	Description
SC-GI/199	150mm long

## Kilner Needle Holder

Box joint, cross-serrated jaw

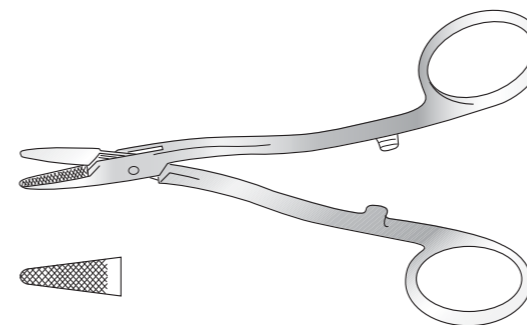

Code	Description
SC-GI/200	165mm long
SC-GI/201	133mm long

# Needle Holders

## Lawrence Needle Holder

Fine jaw, 150mm long

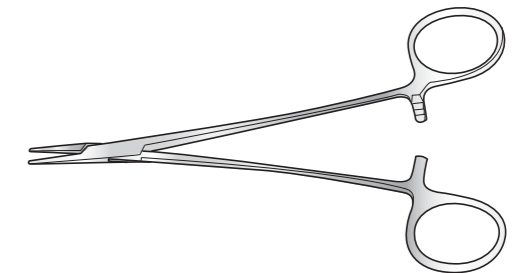

Code	Description
SC-PL/012a	
SC-PL/012b	Tungsten carbide jaw

## Needle Holder

Surgical Holdings pattern, box joint, lightweight, with curved plain jaws and one offset bow for thumb

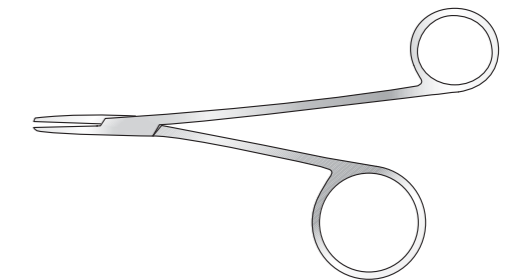

Code	Description
SC-GI/209	152mm long

## MacPhail Needle Holder

Screw joint, with one copper jaw

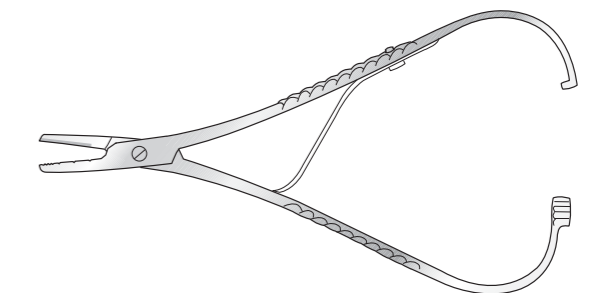

Code	Description
SC-GI/206	159mm long
SC-GI/207	178mm long
SC-GI/208	209mm long

# Needle Holders

## Mathieu Needle Holder

Screw joint

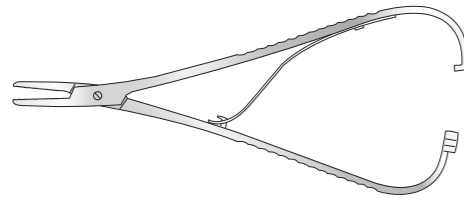

Code	Description
SC-GI/210	172mm long
SC-GI/211	209mm long
SC-GI/212	243mm long

## Mayo Needle Holder

Box joint, straight

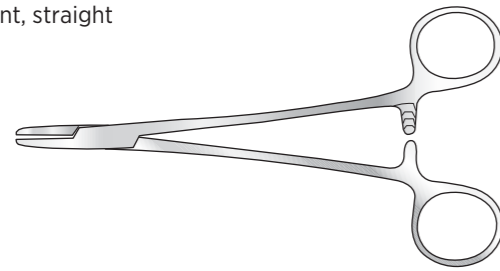

Wide cross serrated jaws

Code	Description
SC-GI/224	159mm long
SC-GI/398	203mm long

Narrow cross serrated jaws



Code	Description
SC-GI/225	159mm long

## Naughton Morgan Needle Holder

Box joints, cross serrated jaws

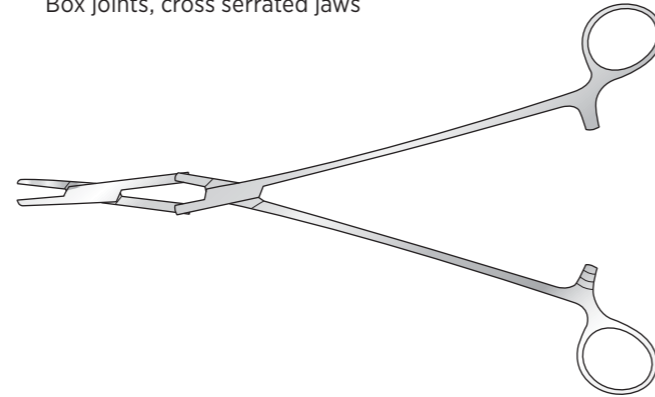

Code	Description
SC-GI/399	185mm long
SC-GI/400	254mm long

Tungsten carbide

Code	Description
SC-GI/401	185mm long
SC-GI/402	254mm long

## Rochester-Mayo Needle Holder

Screw joint

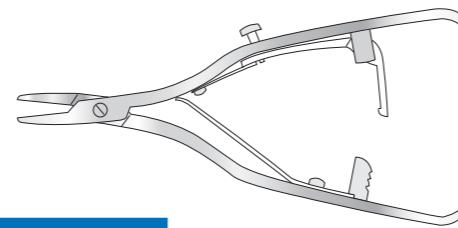

Code	Description
SC-GI/213	178mm long

WITH TWO GOLD BOWS FOR IDENTIFICATION

# Tungsten Carbide Needle Holders

## Berry Needle Holder/Wire Twister

Tungsten carbide jaws

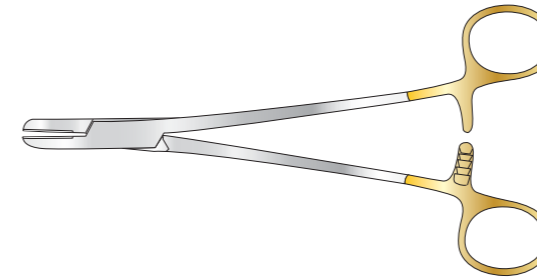

Code	Description
SC-GI/467	200mm long

## Crile-Wood Needle Holder

Tungsten carbide insert, box joint, satin finish, straight

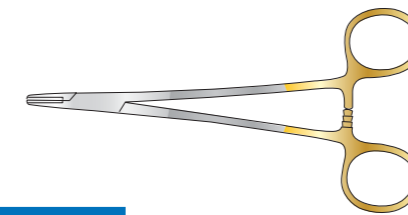

Code	Description
SC-GI/217	159mm long
SC-GI/218	178mm long
SC-GI/198	150mm long

## Derf Needle Holder

Tungsten carbide insert

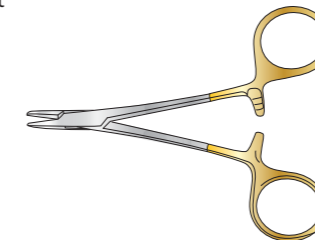

Code	Description
SC-GI/BUPHF002	115mm long

## Finochietto Needle Holder

Tungsten carbide jaws

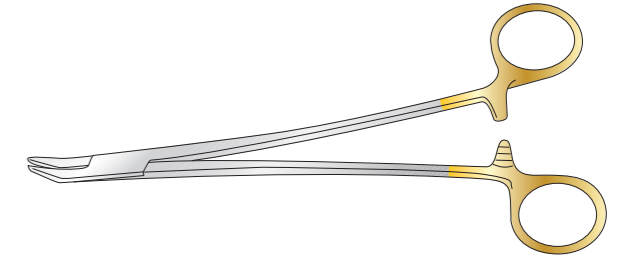

Code	Description
SC-GI/222	215mm long
SC-GI/223	265mm long

## Halsey Needle Holder

Tungsten carbide insert, box joint, satin finish, straight

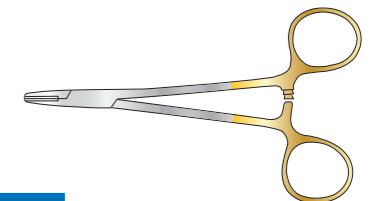

Code	Description
SC-GI/220	127mm long

## Kilner Needle Holder

Tungsten carbide insert

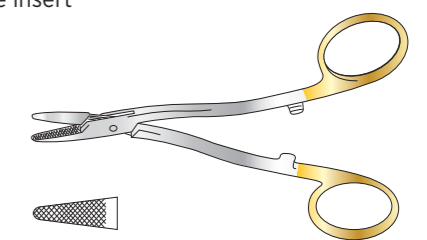

Code	Description
SC-GI/221	140mm long

## Choosing the most suitable needle size

Our tungsten carbide inserts are available in a variety of styles. Choosing the most suitable needle size for each procedure helps give the surgeon maximum grip and control.

### Coarse 0.65mm

For powerful needle holder patterns and wire twisters. Maximum holding capabilities for heavy needles or wire.

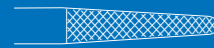

### Micro 0.2-0.3mm

For micro needle holders such as Castroviejo, Microvascular and Mini-Ryder. For delicate needles and sutures between 7-0 and 10-0.

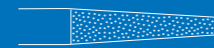

### Standard 0.5mm

Used, for example, in Mayo-Hegar, Mathieu Needle Holders. For needles 3-0 and larger.



### Smooth

Smooth tungsten carbide surface reduces damage to delicate needles and suture of 6-0 and finer.



### Fine 0.4mm

For delicate needle holders such as Crile-Wood and DeBakey. For needles and sutures between 4-0 and 6-0.



# Tungsten Carbide Needle Holders

**WITH TWO GOLD BOWS FOR IDENTIFICATION**

## Masing Needle Holder

Tungsten carbide insert, one angled bow

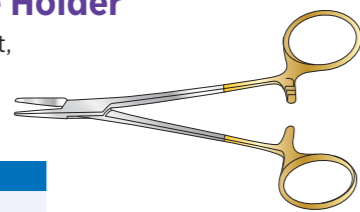

Code	Description
SC-GI/009R	130mm long

## Nievert Needle Holder

Tungsten carbide insert, box joint, satin finish, straight

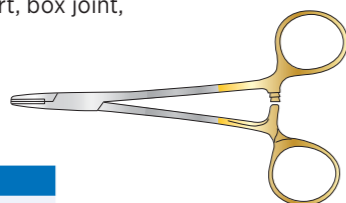

Code	Description
SC-GI/219	127mm long

## DeBakey Needle Holder

250mm long

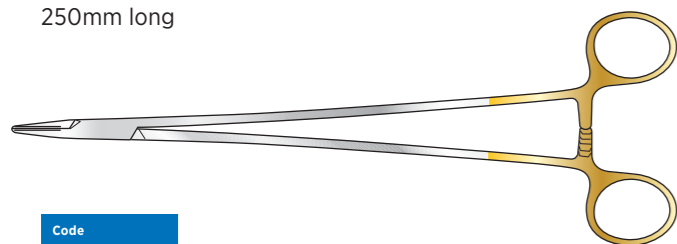

Code
THO/SC-5642a

## Ryder Needle Holder

Tungsten carbide insert, box joint, satin finish, straight

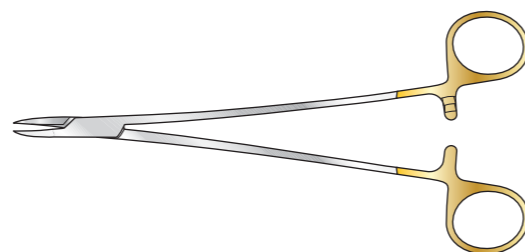

### 0.2mm jaw pitch

Code	Description
SC-GI/SH-5197a	135mm long
SC-GI/SH-5197b	155mm long
SC-GI/SH-5197c	175mm long
SC-GI/SH-5197d	210mm long

### 0.4mm jaw pitch

Code	Description
SC-GI/SH-5198a	135mm long
SC-GI/SH-5198b	155mm long
SC-GI/SH-5198c	175mm long
SC-GI/SH-5198d	210mm long

## Sarot Needle Holder

Diamond jaw, tungsten carbide, gold plated bows

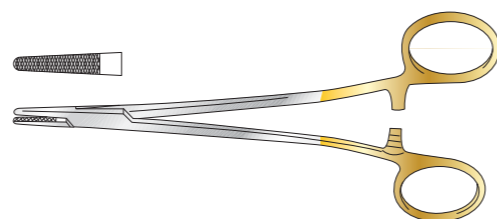

Code	Description
SC-GI/451	181mm long

## Mayo-Hegar Needle Holder

Tungsten carbide insert, box joint, satin finish, straight

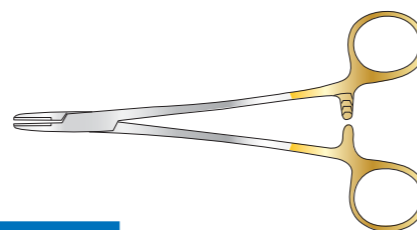

Code	Description
SC-GI/472	130mm long
SC-GI/214	159mm long
SC-GI/215	178mm long
SC-GI/216	209mm long

LONGER SIZES AVAILABLE

# Combined Scissor and Needle Holders

## Olsen-Hegar Scissor/Needle Holder

With tungsten carbide insert

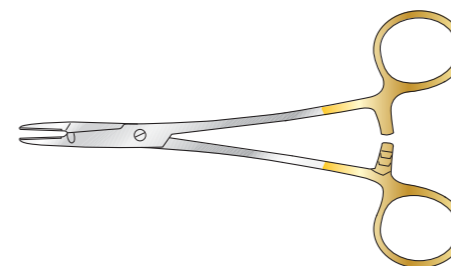

Code	Description
SC-GI/229	147mm long
SC-GI/230	165mm long

## Gillies Scissor/Needle Holder

Right-hand, with tungsten carbide insert



Code	Description
SC-GI/235	158mm long

## Gillies Scissor/Needle Holder

158mm long



Code	Description
SC-GI/231	Right-hand
SC-GI/232	Left-hand

## Olsen-Hegar Scissor/Needle Holder

Screw joint

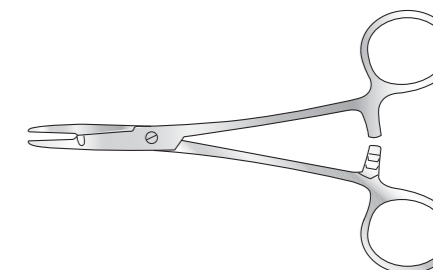

Code	Description
SC-GI/226	140mm long
SC-GI/227	165mm long
SC-GI/228	190mm long

## Gillies Scissor/Needle Holder

Heavy pattern, 158mm long



Code	Description
SC-GI/233	Right-hand
SC-GI/234	Left-hand

## Foster Gillies Scissor/Needle Holder

Fine pattern

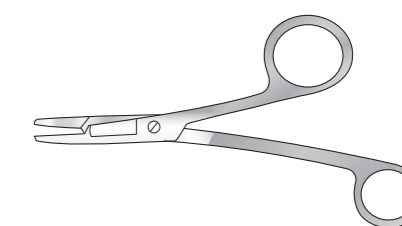

Code	Description
SC-GI/236	127mm long

## Tungsten Carbide Needle Holders

### Features and Benefits

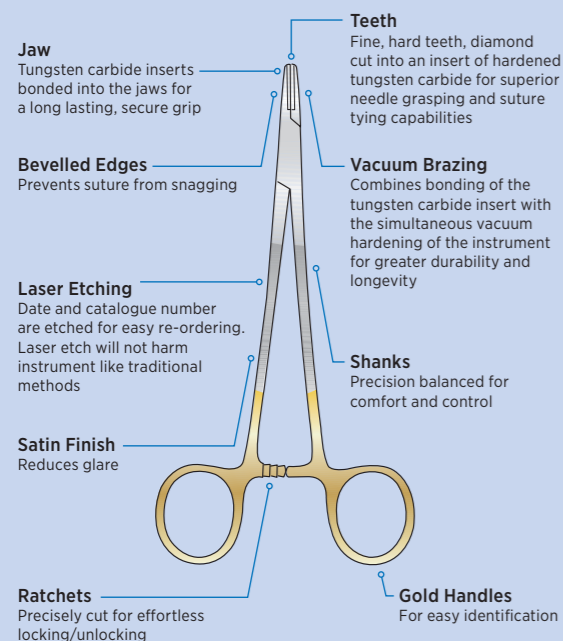

# Bag and Towel Clips

## Spring Clip

Serrated pattern, stainless steel, for fixing slings to leg splints, also for towel clipping

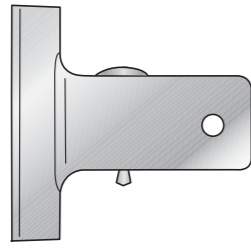

Code	Description
SC-GI/344	63mm wide

## Spring Bag Clip

Serrated

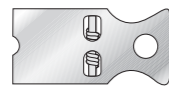

Code	Description
SC-GI/345	26mm wide

## Jones Towel Clip

Superior quality spring forcep type

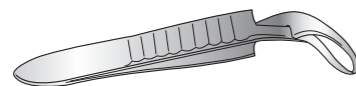

Code	Description
SC-GI/346	89mm long

## Shardles Towel Clip

Spring curved, cross action

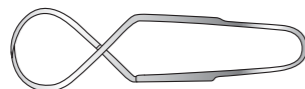

Code	Description
SC-GI/347	77mm long

## Backhaus Towel Clip

Superior quality, box joint

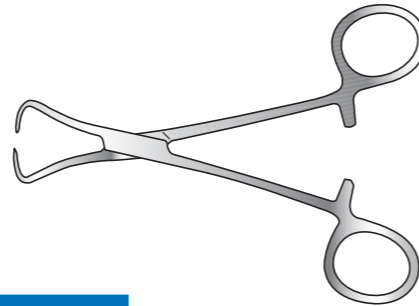

Code	Description
SC-GI/348	89mm long
SC-GI/348a	102mm long
SC-GI/349	130mm long

## Moynihan Towel Clip

Screw joint, 2-2 teeth, for sides of incision

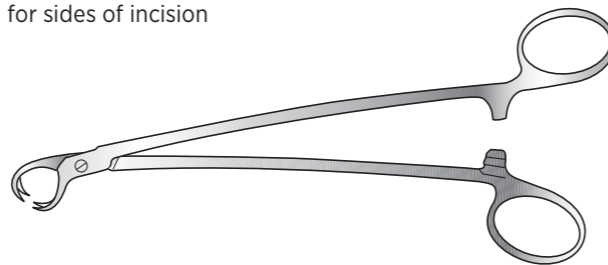

Code	Description
SC-GI/470	191mm long

## Ball and Socket Towel Forceps

Box joint

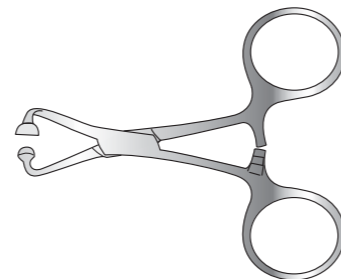

Code	Description
SC-GI/350	89mm long
SC-GI/351	115mm long
SC-GI/352	140mm long

## Goligher Retractor

Complete with 2 centre blades:  
1 x 90mm wide x 50mm deep  
1 x 90mm wide x 90mm deep

and 2 pairs of lateral blades:  
1 pair 25mm wide x 45mm deep  
1 pair 50mm wide x 90mm deep

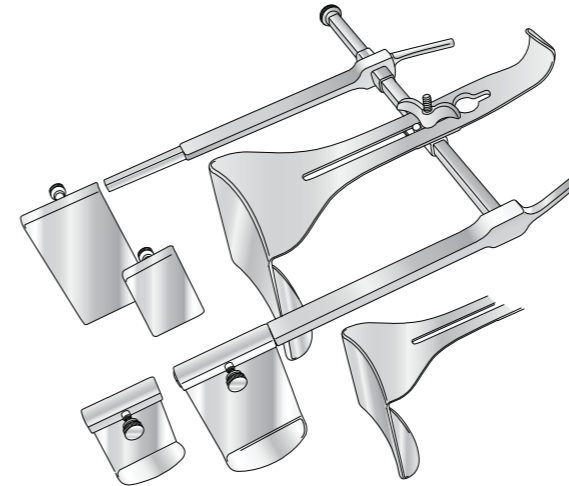

Code
SC-GI/305

## Balfour Abdominal Retractor

Trivalve, frame 203mm

### Child

102mm opening, 51mm deep lateral blades, 38mm deep centre blade

### Adult

178mm opening, 64mm deep lateral blades, 44mm deep centre blade

### Extra large

178mm opening, 102mm deep lateral blades, 108mm deep centre blade

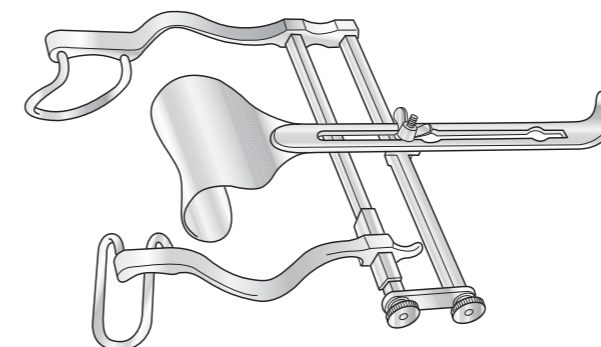

Code	Description
SC-GI/373	Child
SC-GI/374	Adult
SC-GI/375	Extra large

# Retractors

## Miles Retractor

Complete with 2 centre blades:  
1 x 90mm wide x 50mm deep  
1 x 90mm wide x 75mm deep

and 2 pairs of lateral blades:  
1 pair 80mm wide x 35mm deep  
1 pair 80mm wide x 75mm deep

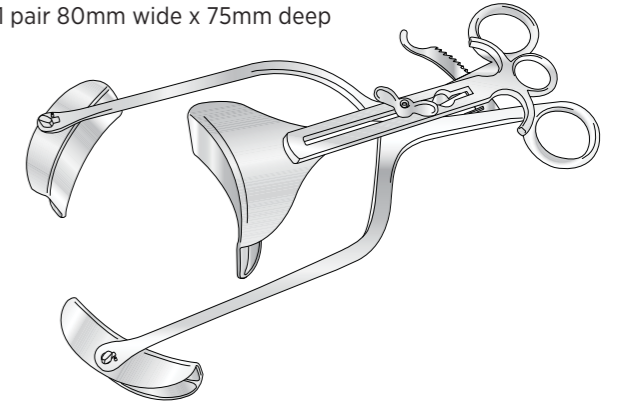

Code	Description
SC-GI/376	340mm long

OTHER BLADE SIZES AVAILABLE

## Balfour Abdominal Retractor

Bivalve, baby

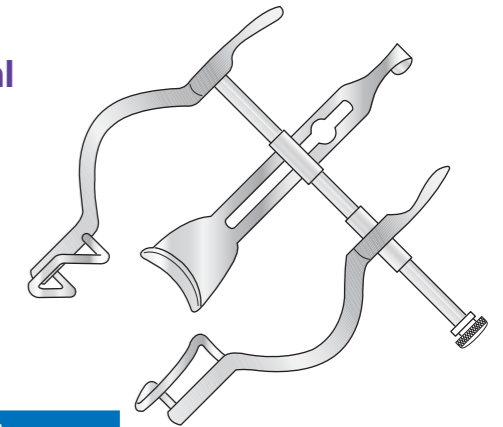

Code	Description
SC-GI/372	Fully open 89mm

## Berkeley Abdominal Retractor

Parallel action

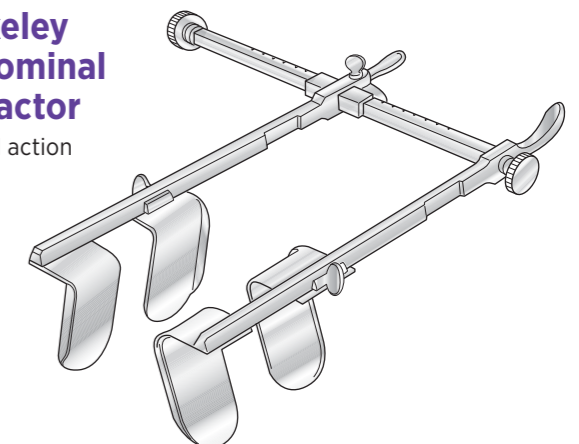

Code	Description
SC-GI/461	Blades 35mm x 60mm deep, 215mm long



# Turner Warwick Retractors

## Turner Warwick Universal Self Retaining Retractor

Code	Description
SC-GI/520	With frames A/B/C/D and blades A/B/C/D/E/F/K/L
SC-GI/521-A	Circular frame A only 178mm
SC-GI/521-B	Circular frame B only 229m
SC-GI/521-C	Circular frame C only 305mm
SC-GI/521-D	Oval frame D only 475mm x 330mm
SC-GI/521-E	Oval frame E only 370mm x 300mm

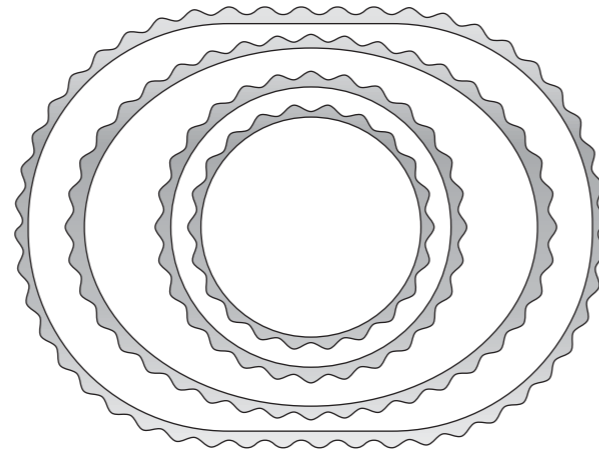

## Turner Warwick Needleholder with Tungsten Carbide Jaws

Curved shanks with one short bow

Code	Description
SH-5835	230mm long
SH-5835A	200mm long

### Blade A



Code	Description
SC-GI/522-A	Blade only - 19mm x 76mm

### Blade B

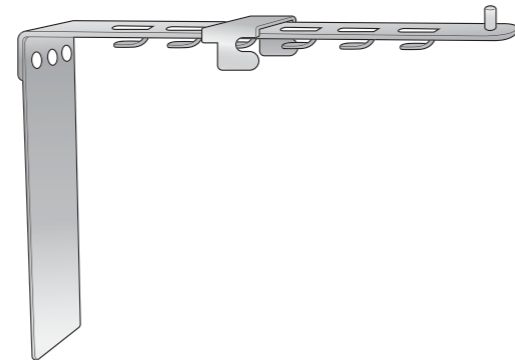

Code	Description
SC-GI/522-B	Blade only - 38mm x 102mm

### Blade C

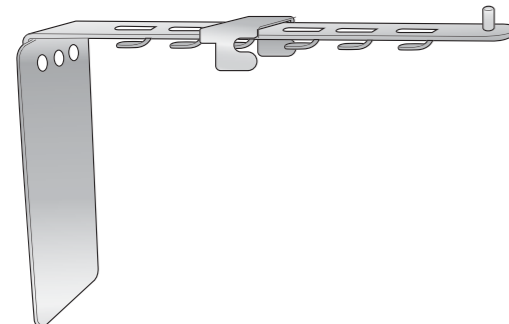

Code	Description
SC-GI/522-C	Blade only - 57mm x 89mm

### Blade D

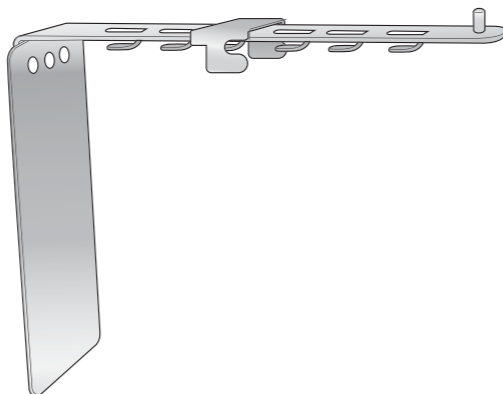

Code	Description
SC-GI/522-D	Blade only - 57mm x 114mm

### Blade E

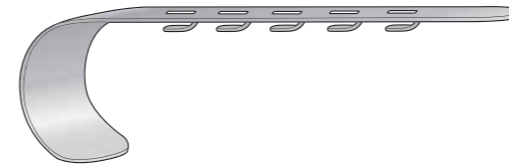

Code	Description
SC-GI/522-E	Blade only - curved stainless steel blade 51mm x 38mm

### Blade F

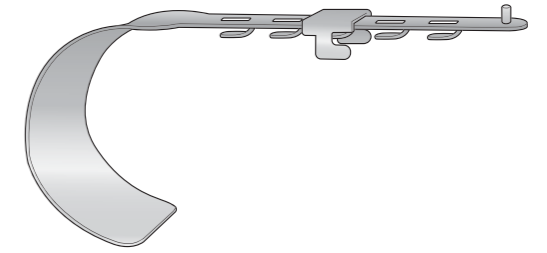

Code	Description
SC-GI/522-F	Blade only - curved stainless steel blade 76mm x 60mm

### Blade G

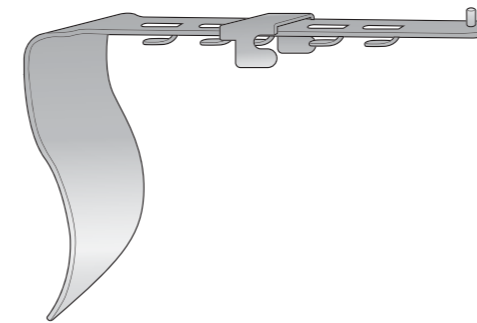

Code	Description
SC-GI/522-G	Blade only - flat stainless steel blade 89mm x 60mm

### Blade J



Code	Description
SC-GI/522-J	Blade only - single hook, 13mm deep

### Blade K

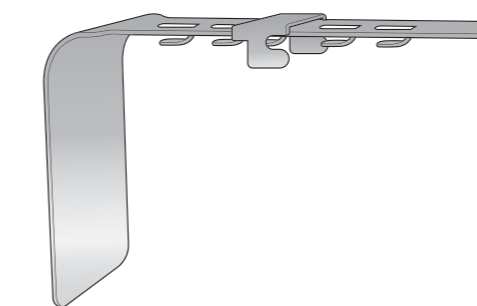

Code	Description
SC-GI/522-K	Blade only - flat with clip 55mm x 90mm

### Blade L

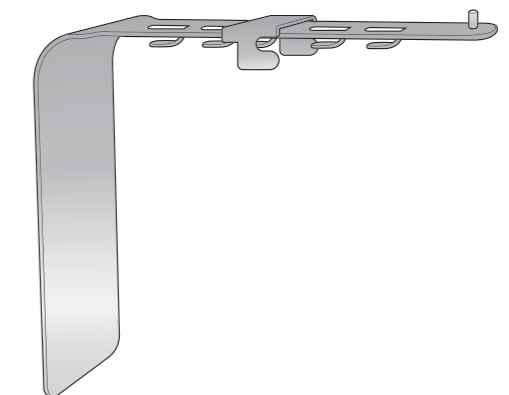

Code	Description
SC-GI/522-L	Blade only - flat with clip 55mm x 120mm

# Turner Warwick Retractors

# Retractors

## Collin Retractor

110mm fully open, 235mm long

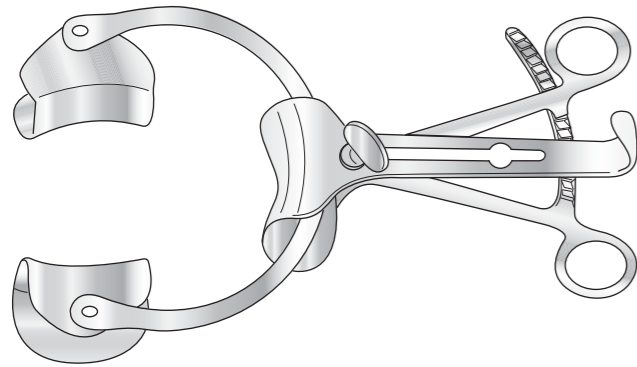

Code	Description
SC-GI/322	Complete with centre blade 55 x 40mm and one pair of blades 38mm x 60mm
SC-GI/322a	Without centre blade

## Gelpi Retractor

Self retaining

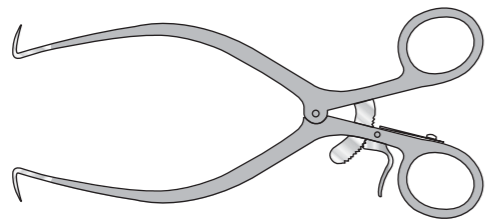

Code	Description
SC-GY/013a	140mm long
SC-GY/013b	178mm long

## Pozzi Abdominal Retractors

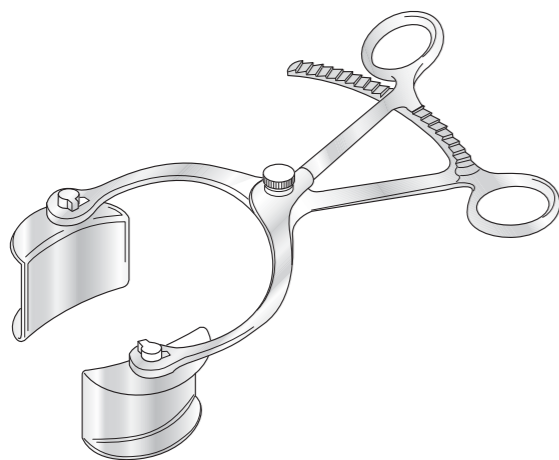

Code	Description
SC-GI/370	Swivel blades: 38 x 60mm, bivalve, 254mm long

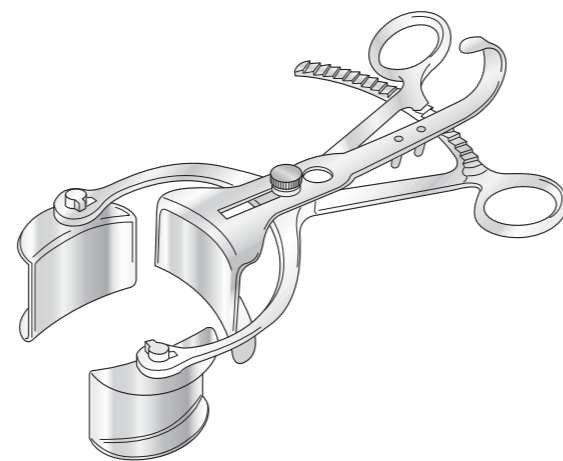

Code	Description
SC-GI/371	Swivel blades: 38 x 59mm, trivalve, 203mm long

## Joll Thyroid Retractor

Self retaining, with lock-in nut

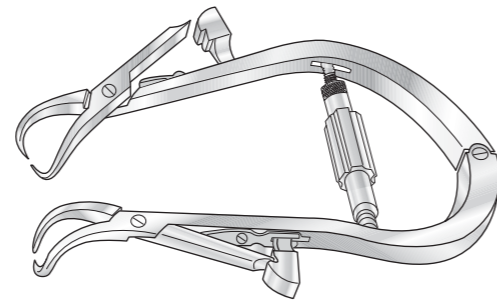

Code	Description
SC-GI/363	152mm long

## Gossett Abdominal Retractor

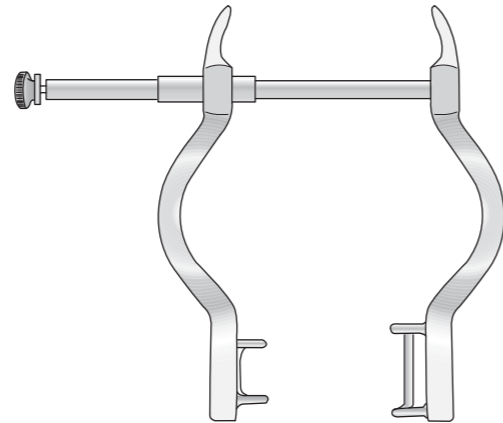

Code	Description
SC-GI/303	Large, fully open 185mm long
SC-GI/304	Small, fully open 95mm long

## Bowlby Dilator

Curved

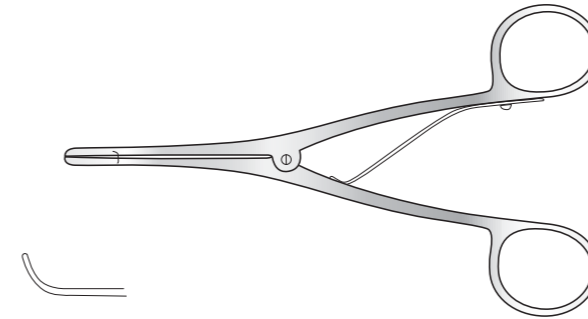

Code	Description
SC-GI/495	145mm long

## Irwin Retractor

Self retaining, with cam rack, 4 x 4 teeth

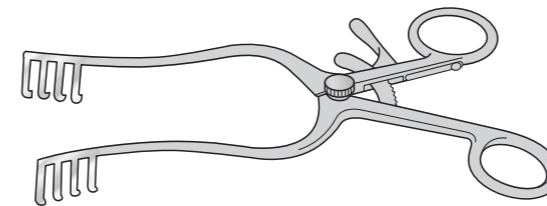

Code	Description
SC-GI/324	178mm long

## Norfolk and Norwich Retractor

4 x 5 teeth 50mm blades x 223mm long

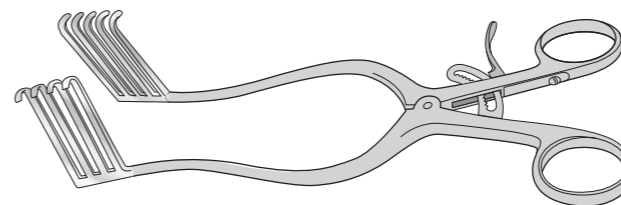

Code	Description
SC-GI/325	Standard rack

## Travers Retractor

Self retaining with internal rack, 210mm long

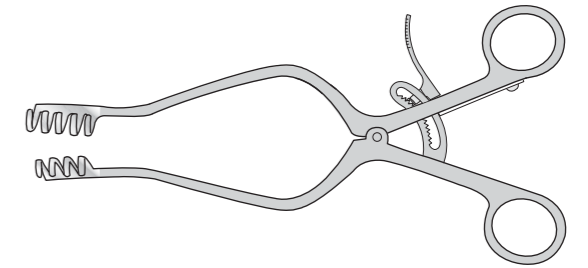

Code	Description
SC-GI/323	4 x 5 teeth, 95mm fully open

## West Retractor

Self retaining, 140mm long

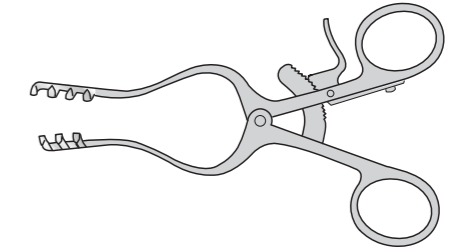

Code	Description
SC-GI/326	3 x 4 teeth, 60mm fully open
SC-GI/326cr	3 x 4 teeth, 60mm fully open, with cam rack

## Weitlander Retractor

3-4 teeth

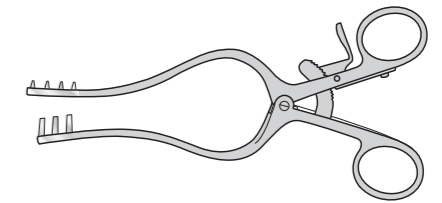

135mm long	
Code	Description
SC-GI/496	Blunt
SC-GI/496a	Sharp
SC-GI/496b	Sharp, 2-3 teeth
SC-GI/496c	Blunt, 2-3 teeth

165mm long	
Code	Description
SC-GI/497	Blunt
SC-GI/497a	Sharp

# Retractors

# Retractors

## Kocher Retractor

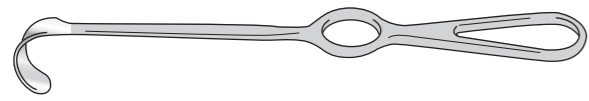

230mm long

Code	Description
SC-GI/378	36 x 20mm blade

250mm long

Code	Description
SC-GI/378a	67 x 25mm blade
SC-GI/378b	80 x 42mm blade
SC-GI/378c	80 x 50mm blade
SC-GI/378d	80 x 60mm blade

## Kocher Langenbeck Retractor

215mm long

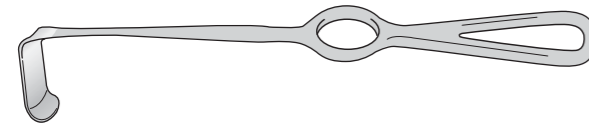

Code	Description
SC-GI/336sp	25 x 6mm blade
SC-GI/379a	35 x 8mm blade
SC-GI/379b	35 x 11mm blade
SC-GI/379c	35 x 15mm blade
SC-GI/357sp	41 x 11mm blade

Code	Description
SC-THO/cutsp015	55 x 11mm blade
SC-GI/379d	70 x 15mm blade
SC-GI/379e	80 x 12mm blade
SC-GI/379f	80 x 16mm blade

## Langenbeck Retractor

Single ended

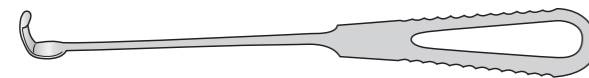

Code	Description
SC-GI/336	Blade 22mm x 6mm
SC-GI/337	Blade 45mm x 13mm
SC-GI/337a	Blade 65mm x 13mm
SC-GI/338a	Blade 75mm x 25mm
SC-GI/338a1	Blade 65mm x 25mm

## Landon Retractor



Code	Description
SC-GI/494	230mm



## Canny Ryall Navy Retractor

Double-ended, with one single hook blade 5mm wide, and one fenestrated blade

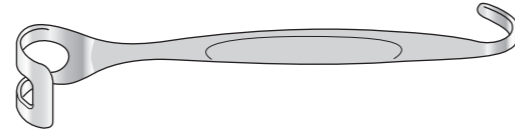

Code	Description
SC-GI/343	Fenestrated blade 16mm wide, 190mm long
SC-GI/343a	Fenestrated blade 19mm wide, 190mm long
SC-GI/343b	Fenestrated blade 25mm wide, 220mm long
SC-GI/343c	Fenestrated blade 30mm wide, 220mm long

## Canny Ryall Army Retractor

Double prong, 13mm wide, 165mm long

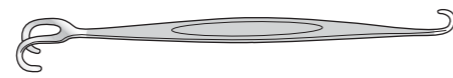

Code	Description
SC-GI/342	Large, 19mm wide
SC-GI/342a	Small, 11mm wide

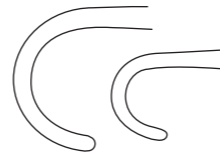

## Czerny Retractor

Double ended

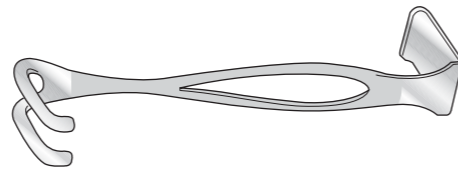

Code	Description
SC-GI/341	171mm long

## Lane Retractor

Double ended blade, 229mm long

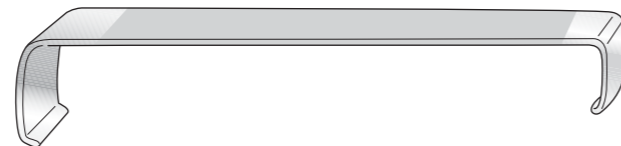

Code	Description
SC-GI/339	13mm x 19mm wide
SC-GI/340	25mm x 32mm wide

## Morris Retractor

Single blade, 229mm long

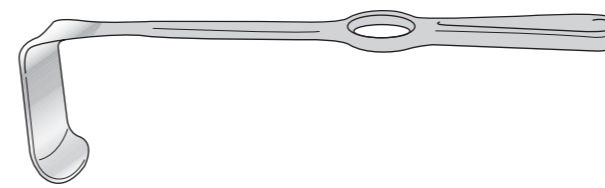

Code	Description
SC-GI/330	38 x 51mm
SC-GI/331	51 x 51mm
SC-GI/332	64 x 51mm

## Moyniham Retractor

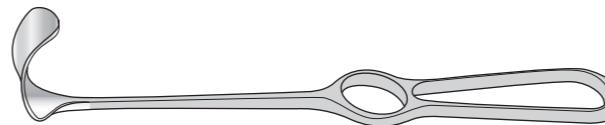

Code	Description
SC-GI/462	Single ended, blade 13 x 22mm, 215mm long

## Elliot (Modified Deaver) Retractor

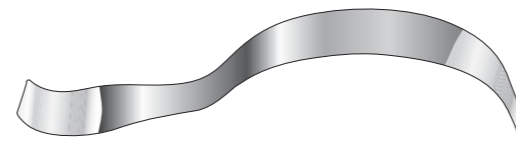

Code	Description
SC-GI/308M	With flat handle

## Deaver Abdominal Retractors

With round handles

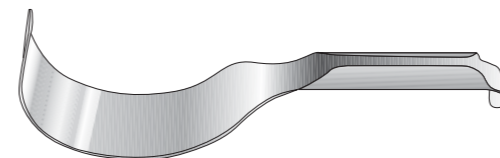

Code	Description
SC-GI/312	Set of 5, 305mm overall length
SC-GI/313	25mm wide
SC-GI/314	25mm wide
SC-GI/315	38mm wide
SC-GI/316	51mm wide
SC-GI/317	76mm wide

# Retractors

## Morris Retractor

Double ended, 216mm long

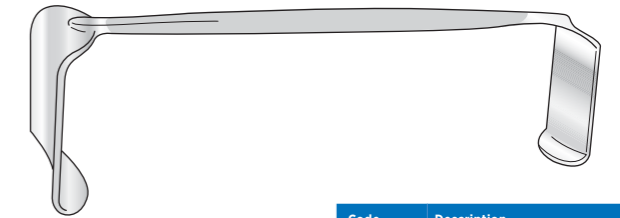

Code	Description
SC-GI/327	32 x 51mm and 38 x 51mm
SC-GI/328	44 x 51mm and 51 x 51mm
SC-GI/329	64 x 51mm and 38 x 51mm

## Deaver Abdominal Retractors



Code	Description
SC-GI/306	Set of 5, 315mm overall length
SC-GI/307	25mm wide
SC-GI/308	25mm wide
SC-GI/309	38mm wide
SC-GI/310	51mm wide
SC-GI/311	76mm wide

## Dyball and Lock Retractor

For liver



Code	Description
SC-GI/335	64 x 144mm, 241mm long

OTHER SIZES AVAILABLE - PRICE ON APPLICATION

## Kelly Retractor Blade

267mm long

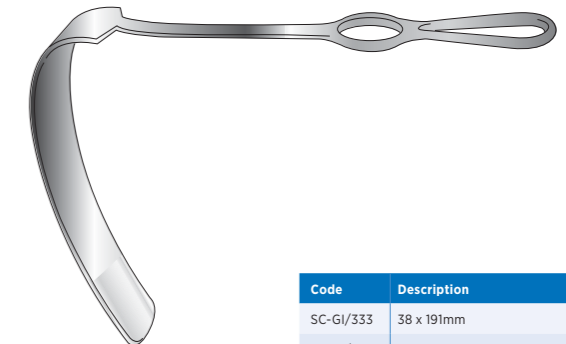

Code	Description
SC-GI/333	38 x 191mm
SC-GI/334	57 x 191mm

## Retractors

### Durham Retractor

With fenestrated blade, 216mm long

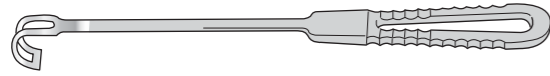

Code	Description
SC-GI/300	10mm wide
SC-GI/301	14mm wide
SC-GI/302	20mm wide

### Ballance (Volkman) Retractor

203mm long

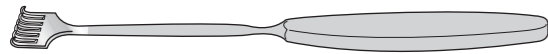

#### Sharp

Code	Description
SC-GI/463	1 prong
SC-GI/463a	2 prong
SC-GI/463b	3 prong
SC-GI/463c	4 prong
SC-GI/463d	6 prong

#### Blunt

Code	Description
SC-GI/463e	1 prong
SC-GI/463f	2 prong
SC-GI/463g	3 prong
SC-GI/463h	4 prong
SC-GI/463i	6 prong

### Volkman Retractor



Code	Description
SC-OR/400	Sharp, 220mm long
SC-OR/400a	Blunt, 220mm long
SC-OR/400b	Sharp, 245mm long

### Kilner Retractor

Double ended, cat's paw

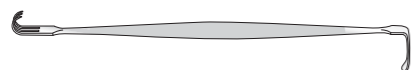

Code	Description
SC-PL/056	152mm long

### Kocher Retractor



Code	Description
SC-OR/N036c	Sharp, 205mm long
SC-OR/N036	Sharp, 220mm long
SC-OR/N036b	Blunt, 220mm long

### Senn-Miller Retractor

170mm long



Code	Description
SC-SH/5881	

### Single Hook Retractor

Sharp



Code	Description
SC-GI/SH5671	152mm long
SC-PL/065b	Half size, fine

### Gillies Skin Hook

Solid handle, 190mm long



Code	Description
SC-PL/065a	Standard, fine
SC-PL/065b	Half size, fine

### MacDonald Dissector Double Ended



Code	Description
SC-GI/285	191mm long

### Brodie Director Probe Ended, Silver Plated



Code	Description
SC-GI/286	165mm long

### Watson Cheyne Dissector

Fine, double-ended, with probe end



Code	Description
SC-GI/287	127mm long
SC-GI/288	191mm long
SC-GI/288a	230mm long
SC-GI/288b	255mm long

### Probe, Malleable Silver Plated



Code	Description
SC-GI/289a	127mm long
SC-GI/289	152mm long
SC-GI/290	178mm long
SC-GI/291	203mm long
SC-GI/292	255mm long
SC-GI/292a	305mm long

## Dissectors and Probes

### Probe, Sinus Silver



Code	Description
SC-GI/464	152mm long

### Probe, Fish Tail Silver Plated



Code	Description
SC-GI/293	127mm long
SC-GI/294	152mm long
SC-GI/295	203mm long
SC-GI/296	254mm long

### Jobson Horne Probe Dressing (Aural)

With one flat tapered end, serrated edge and one small ring end, stainless steel



Code	Description
SC-GI/297	140mm long
SC-GI/298	178mm long

### Bookwalter® Retractor Kit III

A table-fixed retractor system designed by surgeons to efficiently and reliably hold surgical instruments in place during surgery while allowing greater visibility.

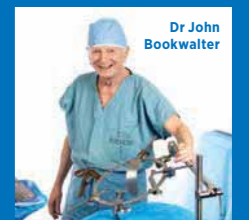

Kit includes Bookwalter® Kit: Table Post and Coupling, Horizontal Flex Bar, Segmented Rings, Tilt Ratchet Mechanism, Kelly Retractors, Blades and Ratchets

Contact us for full details at [info@surgicalholdings.co.uk](mailto:info@surgicalholdings.co.uk)

# Miscellaneous

## Aneurysm Needle

Small, for infusions



Code	Description
SC-GI/472a	146mm long

## Syme Aneurysm Needle

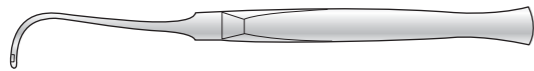

Code	Description
SC-GI/473	165mm long

## Ring Cutter

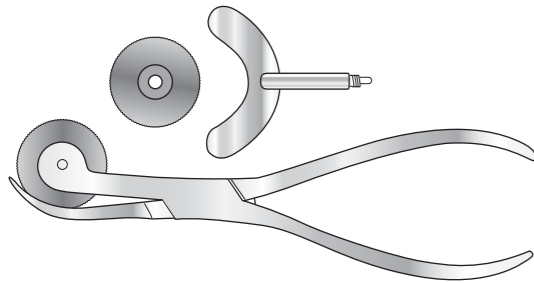

Code	Description
SC-GI/452	Circular saw blade, 165mm long
SC-GI/452a	Spare blade

## Mayo Instrument Pin

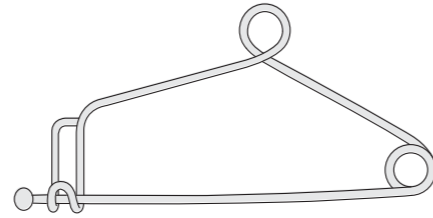

Code	Description
SC-GI/355	102mm long
SC-GI/356	152mm long

## Baron Scalpel Handle

130mm long



Code	Description
SC-PM/003	No 3
SC-PM/004	No 4

## Scalpel Handle

127mm long



Code	Description
SC-PM/007	No 3
SC-PM/008	No 4
SC-PM/008a	No 4 L
SC-PM/001a	No 7

## Endoscope Re-fibre

Surgical Holdings manufacture their own fibre bundles in house. We cover small and larger diameter scopes and only use high quality German fibre optic material and stainless steel tubing.

- Quality components, globally sourced:
  - ✓ Medical grade stainless steel tubing
  - ✓ German engineered new glass fibre
  - ✓ New fibre cone as standard
- ✓ New solderable sapphire distal window
  - ✓ New light post colour ring
  - ✓ New objective in 95% of cases
  - ✓ Replacement 'O' ring to prevent leakage

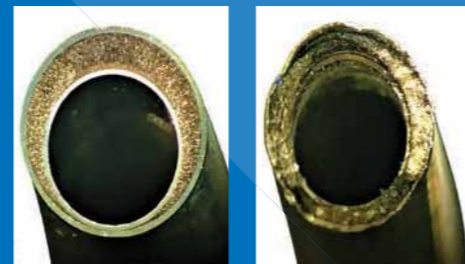

After repair

Before repair

Contact us with your requirements  
[info@surgicalholdings.co.uk](mailto:info@surgicalholdings.co.uk)

# Hollow Ware

## Kidney Dish

Stainless steel

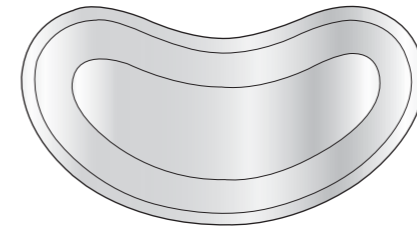

Code	Description
SC-GI/380	152mm
SC-GI/381	203mm
SC-GI/382	254mm
SC-GI/383	305mm

## Lotion Bowl

Without lid, stainless steel

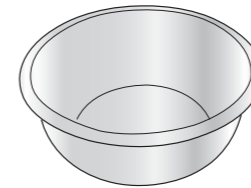

Code	Description
SC-GI/384	102mm
SC-GI/385	152mm
SC-GI/386	203mm
SC-GI/387	254mm
SC-GI/388	305mm

## Instrument Tray

Stainless steel

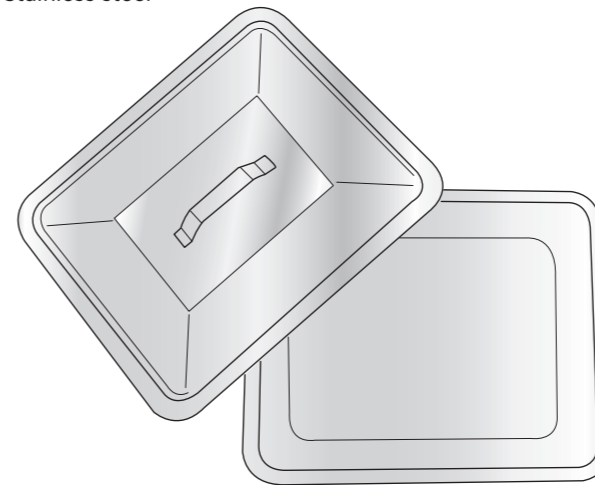

Code	Description
SC-GI/389	254 x 203 x 50mm
SC-GI/390	Lid only for 254 x 203 x 50mm
SC-GI/391	305 x 254 x 50mm
SC-GI/392	Lid only for 305 x 254 x 50mm
SC-GI/393	356 x 305 x 50mm
SC-GI/394	Lid only for 356 x 305 x 50mm

## Cheate Jar

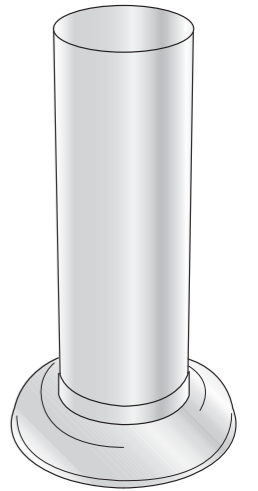

Code	Description
SC-GI/397	Stainless steel, 203mm x 50mm

## Measuring Jug



Code	Description
SC-GI/395	1 litre capacity

## Petri Dish



Code	Description
SC-SH/002149	100mm, stainless steel, with lid

## Gallipot

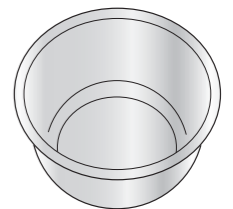

Code	Description
SC-GI/396	Stainless steel, 63mm

# Silicone Matting and Wire Sterilising Baskets

## Silicone Matting

Medical grade for storage, sterilisation and transportation of instruments.

Cushion, protect, and organise delicate surgical instruments during storage, transportation, and sterilisation. Perforations allow for ventilation during the sterilisation process. The silicone mat can be cut to fit any size container.

**SILICONE MATTING AVAILABLE FOR ALL BASKETS - PLEASE ASK FOR PRICE**

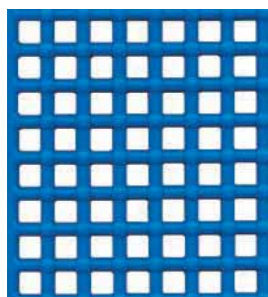

502mm long x 242mm wide  
7mm holes, 10mm between holes

Code
BES/1004M

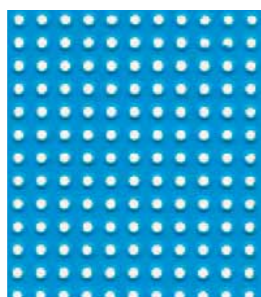

515mm long x 240mm wide  
3mm holes, 6mm between holes

Code
BES/1001M

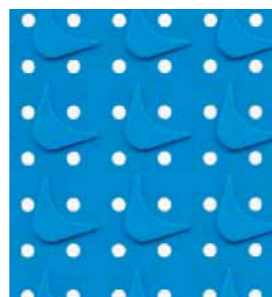

570mm long x 550mm wide  
4mm holes, 13mm between holes

Code
BES/1002M

## Sterilising Baskets

### DIN Basket

Wire mesh base with perforated sides and two carrying handles

Code	Description	Code	Description
SC-GI/CO006	230 x 130 x 60mm	SC-GI/CO013	480 x 250 x 70mm
SC-GI/CO007	240 x 130 x 50mm	SC-GI/CO016	480 x 400 x 60mm
SC-GI/CO008	240 x 130 x 60mm	SC-GI/CO017	480 x 480 x 50mm
SC-GI/CO009	240 x 250 x 50mm	SC-GI/CO018	480 x 480 x 60mm
SC-GI/CO010	240 x 250 x 60mm	SC-GI/CO019	500 x 300 x 50mm
SC-GI/CO014	300 x 300 x 50mm	SC-GI/CO020	550 x 430 x 50mm
SC-GI/CO015	350 x 350 x 60mm	SC-GI/CO021	600 x 300 x 60mm
SC-GI/CO011	480 x 250 x 50mm		
SC-GI/CO012	480 x 250 x 60mm		



### DIN Basket

Wire mesh basket with two carrying handles

Code	Description	Code	Description
SC-GI/CO022	240 x 250 x 50mm	SC-GI/CO026	480 x 250 x 60mm
SC-GI/CO023	240 x 250 x 60mm	SC-GI/CO027	480 x 250 x 70mm
SC-GI/CO024	240 x 250 x 70mm	SC-GI/CO028	480 x 250 x 100mm
SC-GI/CO031	300 x 300 x 60mm	SC-GI/CO029	480 x 480 x 50mm
SC-GI/CO025	480 x 250 x 50mm	SC-GI/CO030	480 x 480 x 70mm

### DIN Basket Lids

For perforated and wire mesh baskets

Code	Description
SC-GI/CO032	240 x 250mm
SC-GI/CO033	300 x 300mm
SC-GI/CO034	480 x 250mm
SC-GI/CO035	480 x 480mm

### Did you know...

**Organising and fixing instruments in place can aid the cleaning process.**

Help keep your instruments in good condition for longer with our baskets and trays. Available in custom sizes, to suit your requirements perfectly.

[info@surgicalholdings.co.uk](mailto:info@surgicalholdings.co.uk)

## ENT Basket

Wire mesh base with perforated sides and two carrying handles, supplied with lid

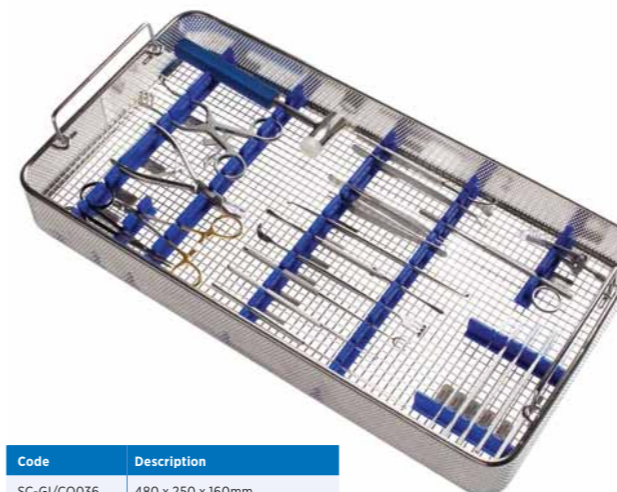

Code	Description
SC-GI/CO036	480 x 250 x 160mm
SC-GI/CO037	Fixing clamps

## Sieve

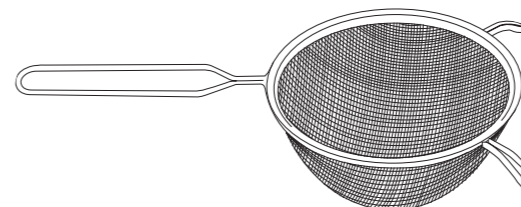

Code	Description
SC-GI/5071	203mm x 50mm ø

## Symmetry Surgical Quadlock Containers



Surgical Holdings offer the unique Quadlock container. The Patented design offers 4 locks, as opposed to the traditional 2, to ensure extra security and peace of mind.

Contact us for full spec and to order  
[info@surgicalholdings.co.uk](mailto:info@surgicalholdings.co.uk)

# Wire Sterilising Baskets

## Arthroscope Basket

Wire mesh base with two fixing clamps



Code	Description
SC-GI/CO001	290 x 80 x 52mm

## Endoscope Basket

With small lens basket

Code	Description
SC-GI/CO002	6400 x 150 x 77mm

Wire mesh base with two fixing clamps

Code	Description
SC-GI/CO003	S - 460 x 80 x 52mm
SC-GI/CO004	D - 480 x 80 x 52mm
SC-GI/CO005	D - 680 x 80 x 52mm

## Fine Mesh Basket



With hinged take off / lockable lid

Code	Description
SC-GI/CO041	120 x 155 x 40mm
SC-GI/CO044	120 x 155 x 50mm
SC-GI/CO042	235 x 155 x 40mm
SC-GI/CO045	235 x 155 x 50mm
SC-GI/CO043	375 x 260 x 40mm

With separate lid

Code	Description
SC-GI/CO038	120 x 155 x 40mm
SC-GI/CO039	235 x 155 x 40mm
SC-GI/CO040	375 x 260 x 40mm

**WE ALSO MAKE CUSTOM BASKETS AND TRAYS, CONTACT US TO DISCUSS YOUR REQUIREMENTS**

# Optical Fibre Cables

Our optical fibre cables are compatible with all major scopes and illuminators. Every light lead is high temperature xenon compatible, rated to the highest level of thermal resistance and tested to ensure the highest light output possible.

**Choice of 10 colours for easy identification**

**Choice of lengths and sheathing types**

**Free on-site light lead testing**  
We'll come and go through your lead stock to ensure your leads are fit for use

**Reinforced for longer life**

## How to order

Select an option from each step to create your part number.  
Example: 474810180FRGY is a Storz Proximal, Storz Distal, 4.8mm Bundle, 254mm Length, Fully Reinforced Sheathing in Grey

### Step 1: Proximal/Illuminator Connector

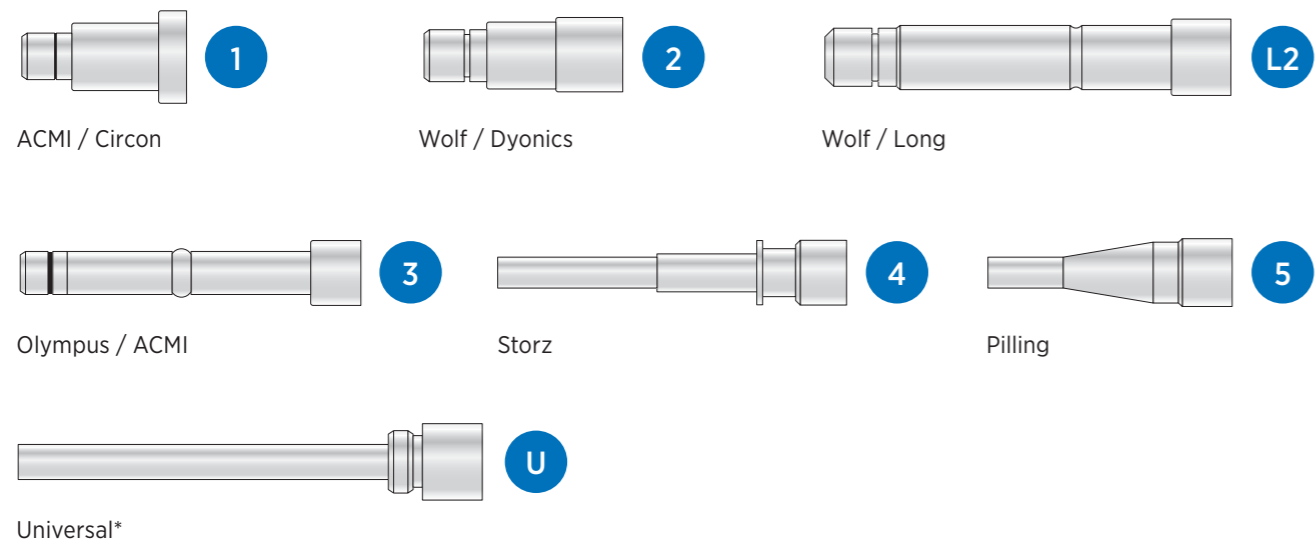

\*A screw-on adapter is necessary for this connector and must be ordered separately

# Optical Fibre Cables

### Step 2: Distal/Instrument Connector

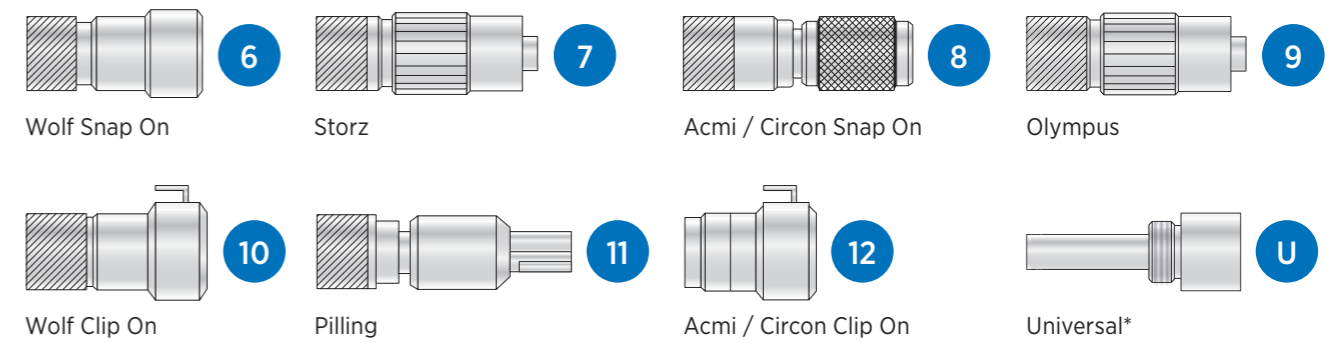

\*A screw-on adapter is necessary for this connector and must be ordered separately

### Step 3: Fibre Optic Bundle Size

Place gauge on bundle to determine diameter

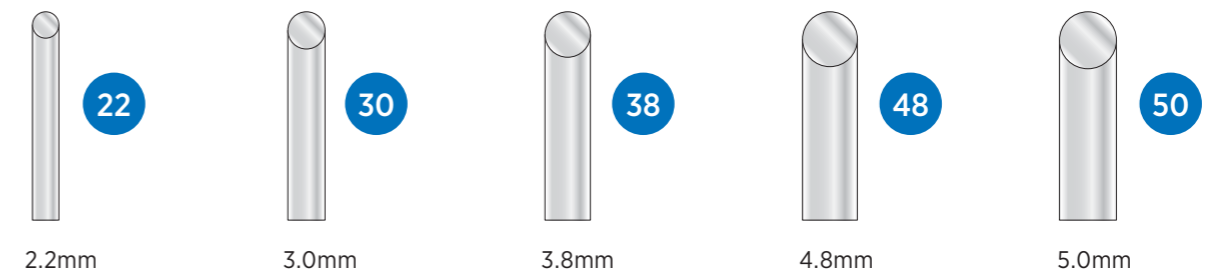

### Step 4: Fibre Optic Cable Length

Custom lengths available

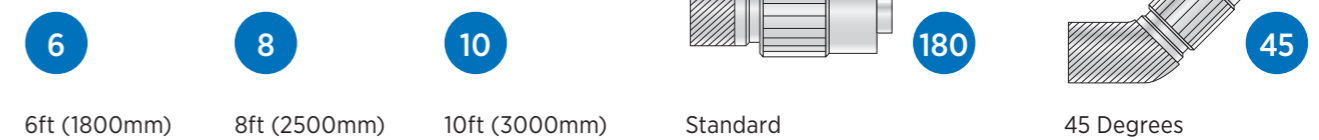

### Step 5: Instrument Connector Angle

### Step 6: Sheathing Type

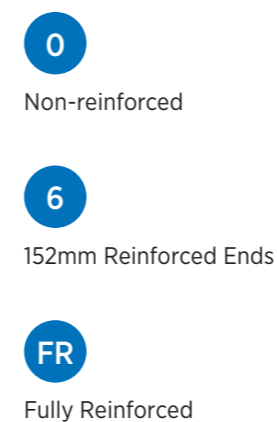

### Step 7: Sheathing Colour

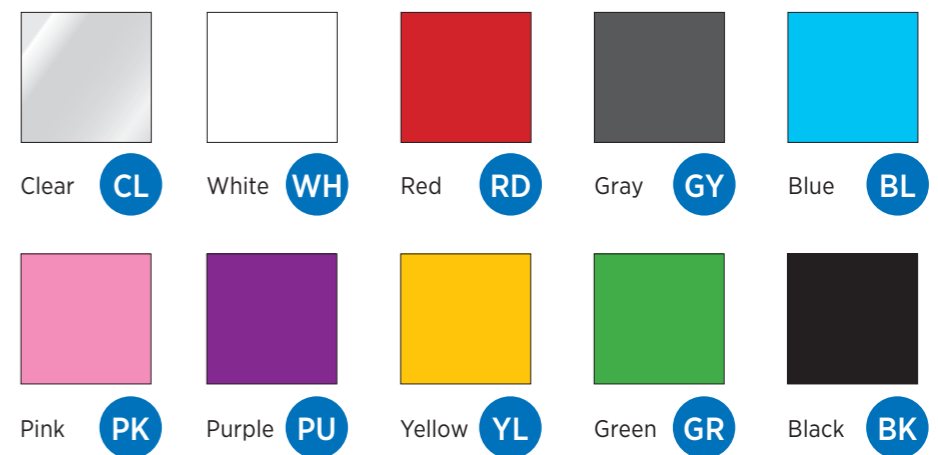

# Dental

Elevators	47
Extracting Forceps	48
Tooth Forceps	51
Wire Cutting Forceps	53

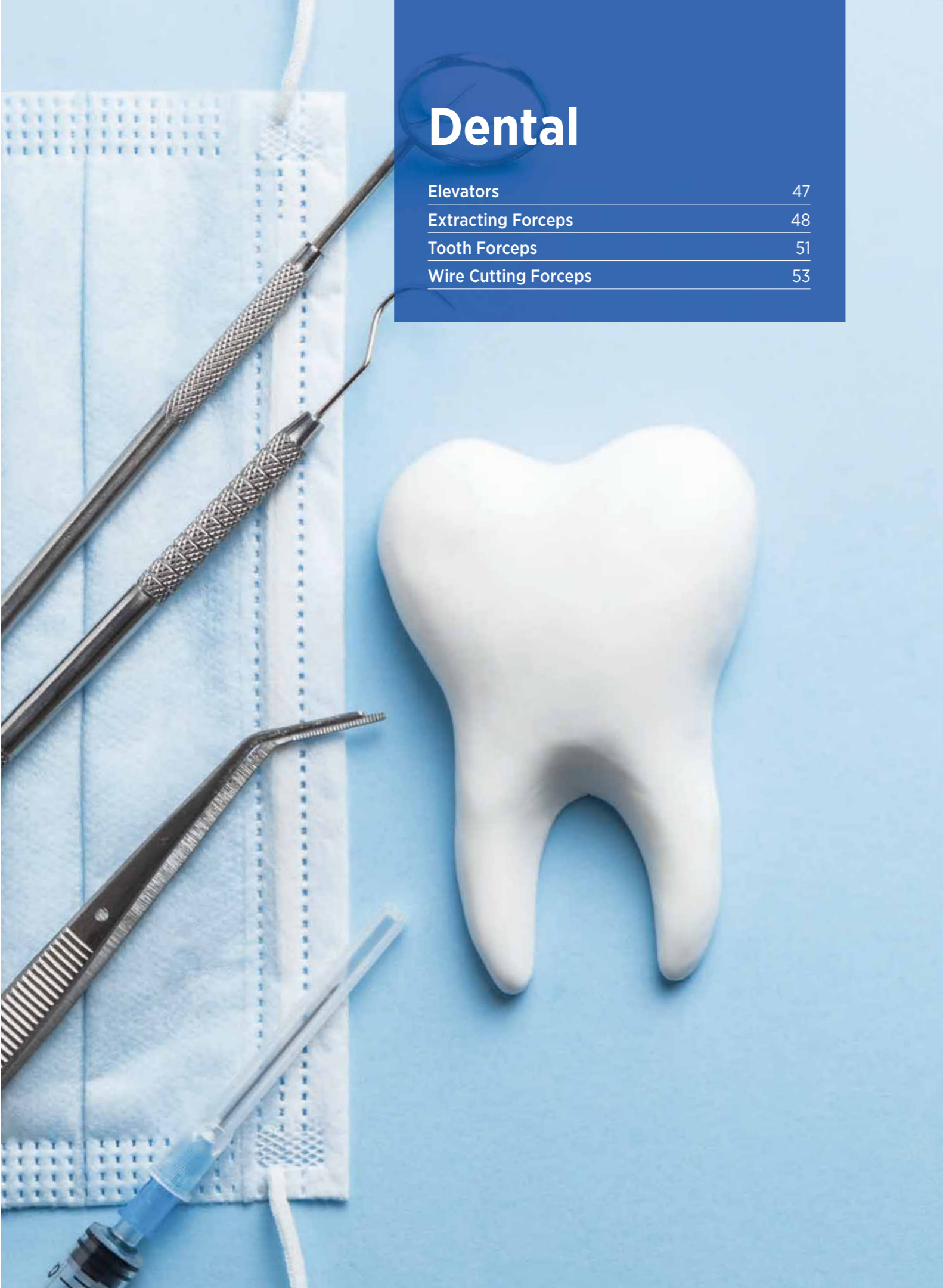

# Elevators

## Bein Elevator

140mm long

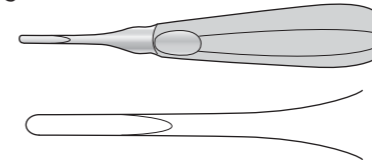

### Straight

Code	Description
SC-DEN/8348	2mm wide
SC-DEN/8346	2.5mm wide
SC-DEN/8344	3mm wide
SC-DEN/8342	3.5mm wide
SC-DEN/8340	4mm wide

### Curved

Code	Description
SC-DEN/8352	2mm wide
SC-DEN/8347	2.5mm wide
SC-DEN/8345	3mm wide
SC-DEN/8343	3.5mm wide
SC-DEN/8341	4mm wide

## Coleman Elevator

145mm long



Code	Description
SC-DEN/8294	Left

Code	Description
SC-DEN/8295	Right

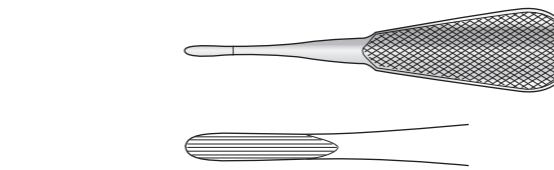

Code	Description
SC-DEN/8273	Straight

## Coupland Elevator

Curved, 150mm long

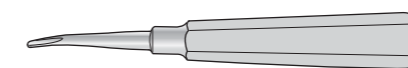

Code	Description
SC-PL/068	3mm wide - Ash no1
SC-PL/068a	4mm wide - Ash no2
SC-PL/068b	5mm wide - Ash no3

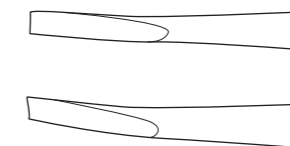

## Cryer-White Elevator

150mm long

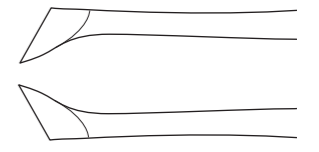

Code	Description
SC-DEN/8261	Left
SC-DEN/8263	Right

## Cryer Elevator

150mm long

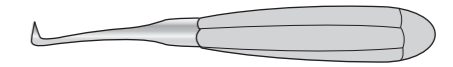

Code	Description
SC-PL/069	Right
SC-PL/069a	Left



## Warwick-James Elevator

150mm long



Code	Description
SC-DEN/8275	Straight
SC-DEN/8249	Left
SC-DEN/8251	Right

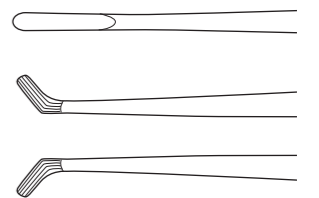

## Winter Elevator

105mm long

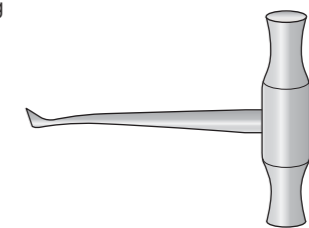

Code	Description
SC-DEN/8338	Left
SC-DEN/8358	Right

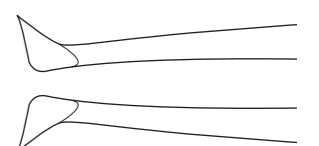



# Extracting Forceps

## Extracting Forceps

For lower molars with decayed or broken crowns either side molars  
180mm long

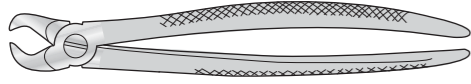

Code	Description
SC-DEN/8578	No 87



## Extracting Forceps

For upper roots  
180mm long

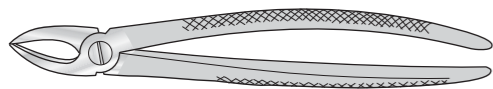

Code	Description
SC-DEN/8530	No 30

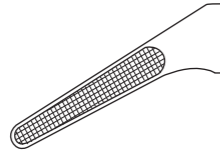

## Extracting Forceps

For upper molars  
180mm long

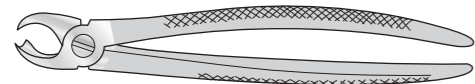

Code	Description
SC-DEN/8588	No 89
SC-DEN/8590	No 90

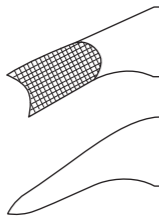

## Extracting Forceps

For lower molars  
165mm long

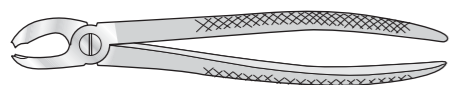

Code	Description
SC-DEN/8520	No 21

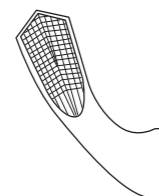

## Extracting Forceps

For lower molars either side  
165mm long

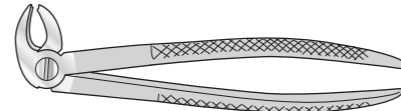

Code	Description
SC-DEN/8522	No 22

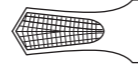

## Extracting Forceps

For upper roots and incisors  
165mm long

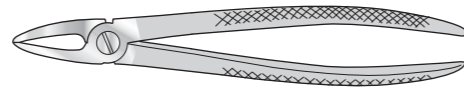

Code	Description
SC-DEN/8522a	No 29

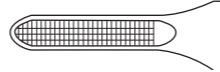

## Extracting Forceps

For upper laterals and canines  
170mm long

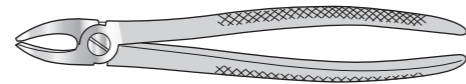

Code	Description
SC-DEN/8500	No 1, 6mm wide
SC-DEN/8502	No 1, 5mm wide

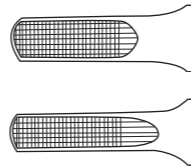

## Extracting Forceps

For lower incisors and canines  
170mm long

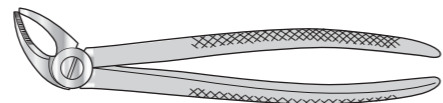

Code	Description
SC-DEN/8504	No 4, 4mm wide

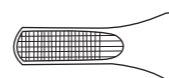

## Extracting Forceps

For lower premolars  
170mm long

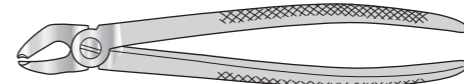

Code	Description
SC-DEN/8508	No 8, 4mm wide

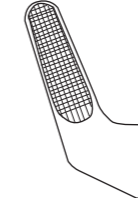

## Extracting Forceps

For lower bicuspid and canines  
170mm long

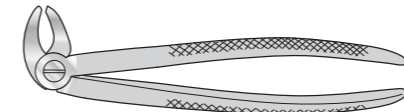

Code	Description
SC-DEN/8512	No 13, 4mm wide

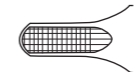

## Extracting Forceps

For upper premolar  
180mm long

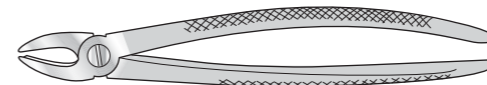

Code	Description
SC-DEN/8506	No 307, 5mm wide

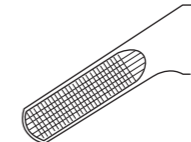

## Extracting Forceps

For upper molars  
180mm long

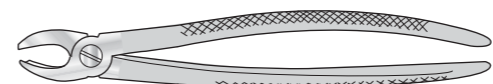

Code	Description
SC-DEN/8516	No 17, right
SC-DEN/8518	No 18, left

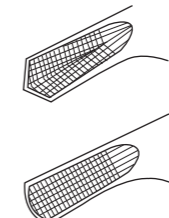

# Extracting Forceps

## Extracting Forceps

For lower molars  
150mm long

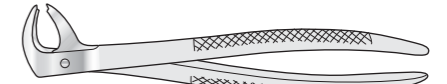

Code	Description
SC-DEN/8566	No 73, 3.5mm wide

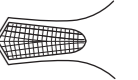

## Extracting Forceps

For lower roots  
150mm long

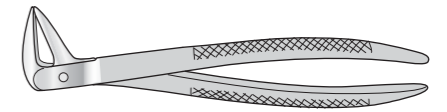

Code	Description
SC-DEN/8568	No 74, 4mm wide

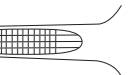

## Extracting Forceps

For lower roots and premolars  
150mm long

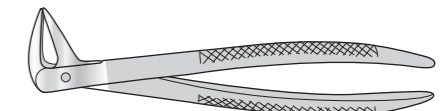

Code	Description
SC-DEN/8570	No 74n, 3mm wide

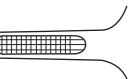

## Extracting Forceps

For lower bicuspid and canines  
150mm long

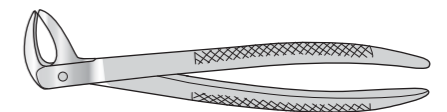

Code	Description
SC-DEN/8572	No 75, 4mm wide

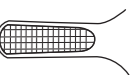

## Extracting Forceps

For lower molars with decayed or broken crowns either side  
150mm long

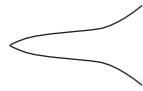
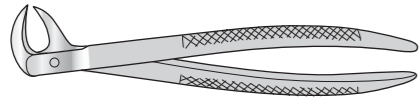

Code	Description
SC-DEN/8576	No 86a

## Extracting Forceps

For upper roots, narrow  
185mm long

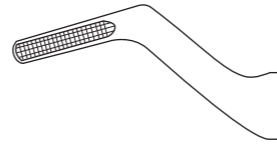
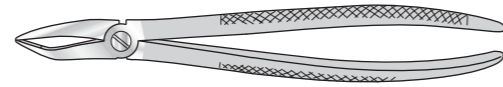

Code	Description
SC-DEN/8552	No 51a, 3mm wide

## Extracting Forceps

For lower roots either side  
165mm long

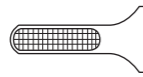
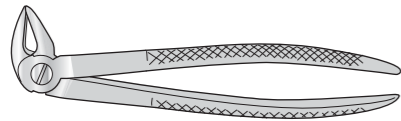

Code	Description
SC-DEN/8532	No 33, 3.5mm wide

## Extracting Forceps

For upper wisdoms either side  
185mm long

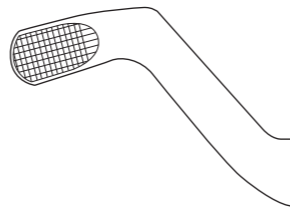
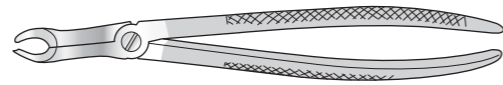

Code	Description
SC-DEN/8560	No 67, 7mm wide

## Extracting Forceps

For upper roots  
185mm long

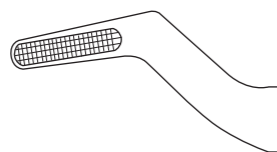
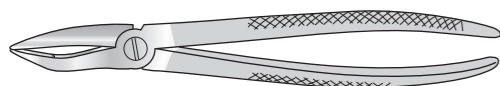

Code	Description
SC-DEN/8550	No 51, 4mm wide

## Extracting Forceps

For lower wisdoms either side  
185mm long

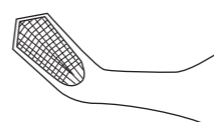
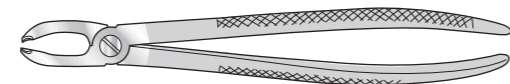

Code	Description
SC-DEN/8574	No 79, 5mm wide

## Cryer Tooth Forceps

For upper incisors and roots  
185mm long

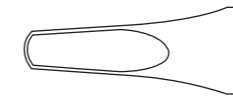
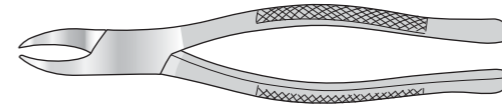

Code	Description
SC-DEN/8010	

## Cryer Tooth Forceps

For incisors and roots  
185mm long

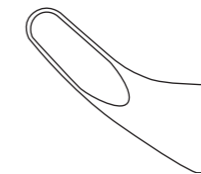
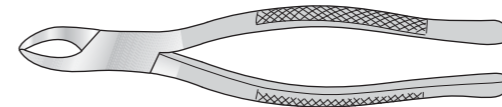

Code	Description
SC-DEN/8014	No 62

## Cryer Tooth Forceps

For upper incisors and roots  
185mm long

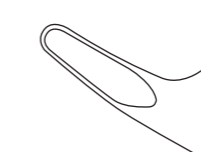
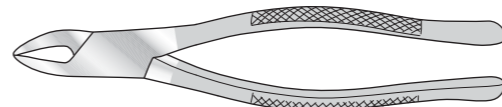

Code	Description
SC-DEN/8012	No 150

## Cryer Tooth Forceps

For incisors and roots  
185mm long

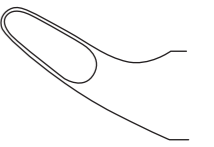
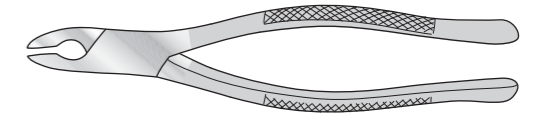

Code	Description
SC-DEN/8013	No 150a

## Tooth Forceps

For lower incisors, bicuspid and roots  
185mm long

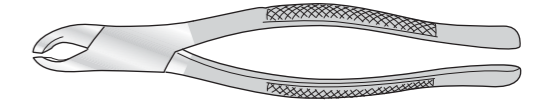

Code	Description
SC-DEN/8036	No 203

## Tooth Forceps

For lower molars either side  
185mm long

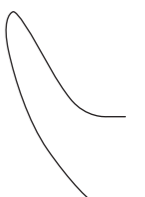
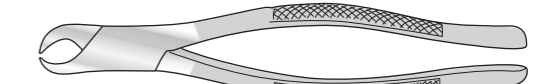

Code	Description
SC-DEN/8039	No 23

# Tooth Forceps

## Tooth Forceps

For lower molars  
185mm long

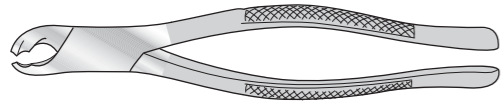

Code	Description
SC-DEN/8042	No 17

## Tooth Forceps

For lower wisdom teeth  
185mm long

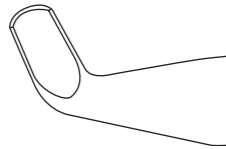
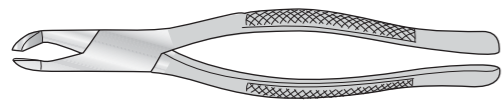

Code	Description
SC-DEN/8043	No 222

## Tooth Forceps

For lower molars either side  
175mm long

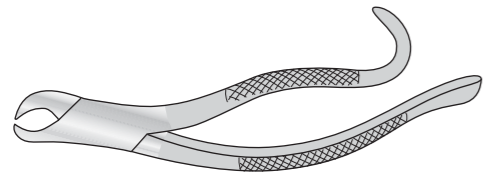

Code	Description
SC-DEN/8040	No 16

## Tooth Forceps

For lower roots, incisors and bicuspid  
175mm long

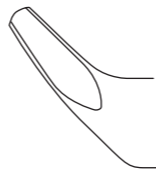
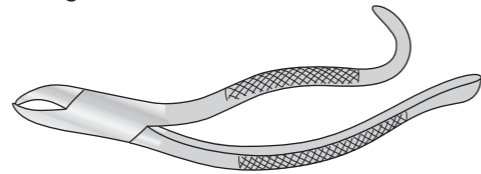

Code	Description
SC-DEN/8045	No 103

## Tooth Forceps for Children

160mm long

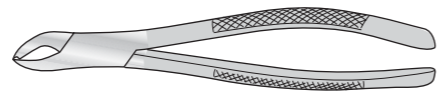

Code	Description
SC-DEN/8037	No 151as, for lower teeth

Code	Description
SC-DEN/8017	No 150as, for upper teeth

## Cryer Tooth Forceps for Children

For upper incisors, canines and bicuspid,  
160mm long

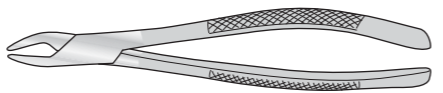

Code	Description
SC-DEN/8011	No 1505

Code	Description
SC-DEN/8033	No 1515

# Wire Cutting Forceps

## Top Cutting Forceps

Tungsten carbide edge, for bone pins up to 2.5mm ø  
gold handles

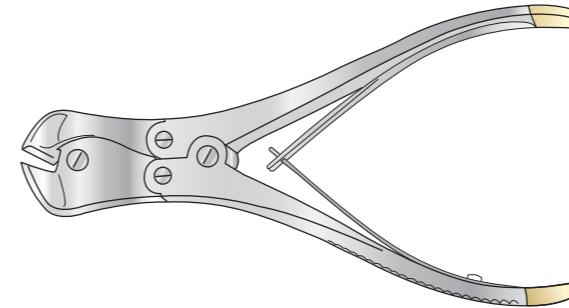

Code	Description
SC-OR/06	215mm long

## Top Cutting Forceps

Tungsten carbide edge, for arthrodesis wire up to 1.5mm ø  
gold handles

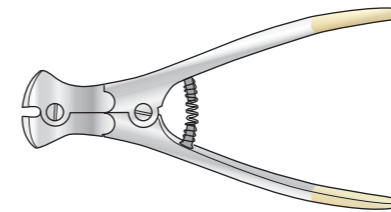

Code	Description
SC-OR/06a	145mm long

## Side Cutting Forceps

Tungsten carbide edge, for bone pins up to 2.2mm ø  
gold handles

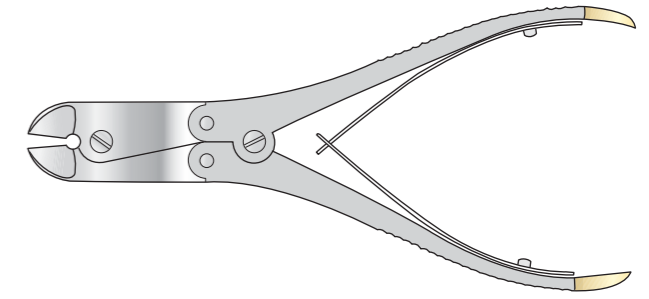

Code	Description
SC-OR/332	230mm long

# Diathermy/ Bipolar

Diathermy Scissors	55
Diathermy Forceps	55
Bipolar Forceps	56
Handles, Needles and Blades	57
Leads	58
Quivers	58

## Diathermy Scissors and Forceps

### Turner Warwick Diathermy Scissors

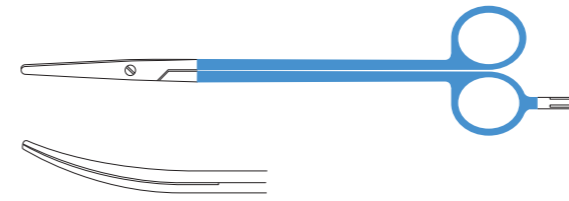

#### Straight

Code	Description
SC-DIA/072	190mm long
SC-DIA/073	230mm long
SC-DIA/074	250mm long

#### Curved

Code	Description
SC-DIA/075	190mm long
SC-DIA/076	230mm long
SC-DIA/077	250mm long

### Riches Artery Forceps

Screw joint, curved

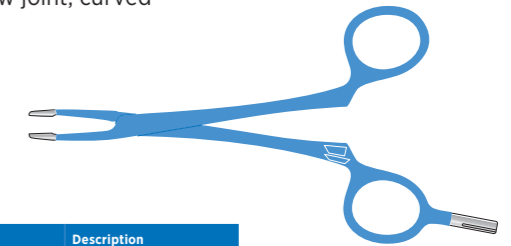

Code	Description
SC-DIA/014	127mm long
SC-DIA/015	152mm long
SC-DIA/016	178mm long
SC-DIA/017	185mm long
SC-DIA/018	228mm long

### Adson Forceps

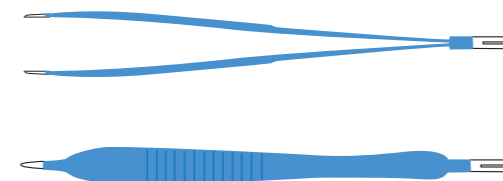

Code	Description
SC-DIA/003	152mm long

### Dissecting Forceps



#### Serrated

Code	Description
SC-DIA/004	152mm long
SC-DIA/005	178mm long
SC-DIA/006	203mm long
SC-DIA/007	228mm long
SC-DIA/008	254mm long

#### 1-2 teeth

Code	Description
SC-DIA/009	152mm long
SC-DIA/010	178mm long
SC-DIA/011	203mm long
SC-DIA/012	228mm long
SC-DIA/013	254mm long

### Wilson Hey Artery Forceps

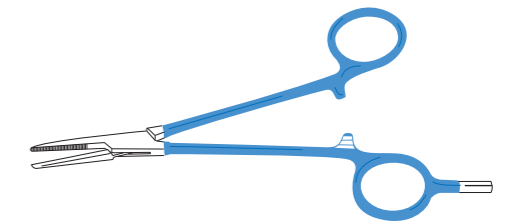

#### Straight

Code	Description
SC-DIA/023	152mm long
SC-DIA/024	178mm long
SC-DIA/025	185mm long
SC-DIA/026	228mm long

#### Curved

Code	Description
SC-DIA/019	152mm long
SC-DIA/020	178mm long
SC-DIA/021	185mm long
SC-DIA/022	228mm long

#### Did you know...

### The difference between Monopolar Electrosurgery and Bipolar Electrosurgery

There is one basic difference between bipolar and monopolar techniques. With monopolar electrosurgery, a probe electrode is used to apply the electrosurgical energy to the target tissue to achieve the desired surgical effect. The current then passes through the patient to a return pad and then back to the ESU generator to complete the circuit.

With the bipolar electrosurgical method a bipolar device, often a set of forceps, is used. The electrical current passes from one side of the forcep, through the target tissue to the other side of the forcep, then back to the generator. The electrical current is restricted to the tissue between the forcep, therefore not requiring the use of a grounding pad.

# Bipolar Forceps

## Bipolar Forceps Straight

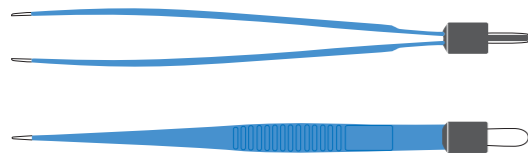

### Fine tip

Code	Description
SC-DIA/034	101mm long
SC-DIA/035	127mm long
SC-DIA/036	152mm long
SC-DIA/037	178mm long
SC-DIA/038	185mm long

### Medium tip

Code	Description
SC-DIA/039	101mm long
SC-DIA/040	127mm long
SC-DIA/041	152mm long
SC-DIA/042	178mm long
SC-DIA/043	185mm long

### Heavy tip

Code	Description
SC-DIA/044	101mm long
SC-DIA/045	127mm long
SC-DIA/046	152mm long
SC-DIA/047	178mm long
SC-DIA/048	185mm long

## Bipolar Forceps Angled

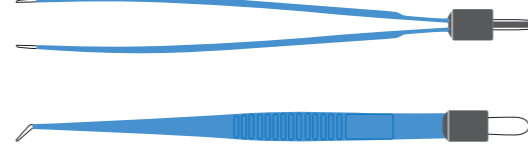

### Fine tip

Code	Description
SC-DIA/049	101mm long
SC-DIA/050	127mm long
SC-DIA/051	152mm long
SC-DIA/052	178mm long
SC-DIA/053	185mm long

### Medium tip

Code	Description
SC-DIA/054	101mm long
SC-DIA/055	127mm long
SC-DIA/056	152mm long
SC-DIA/057	178mm long
SC-DIA/058	185mm long

### Heavy tip

Code	Description
SC-DIA/059	101mm long
SC-DIA/060	127mm long
SC-DIA/061	152mm long
SC-DIA/062	178mm long
SC-DIA/063	185mm long

## Adson Bipolar Forceps

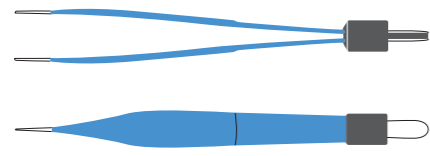

Code	Description
SC-DIA/003a	152mm long

# Need Single Use Instruments?

Order your copy of Surgical Holdings Single Use Solutions brochure

- Light Sticks Flex Lite
- Electrosurgery
- Symmetry Surgical
- Single Use Forceps



Better Availability



Great Range of Products



Perfect Condition, Every Time

info@surgicalholdings.co.uk

# Handles, Needles and Blades

## Monel Handle



Code	Description
SC-DIA/028	145mm long

## Needle Handles



Code
SC-DIA/027

## Abbey Diathermy Needle

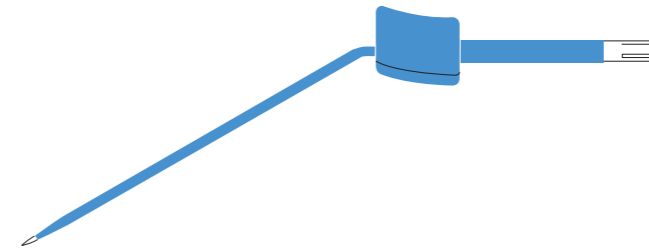

Code
SC-DIA/078

## Finger Switch Pencil

With spatula and 3 metre lead



Code
SC-DIA/068

## Monel Blade

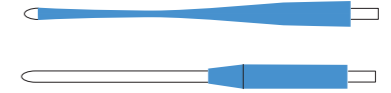

Code	Description
SC-DIA/029	Fully insulated
SC-DIA/030	Non-insulated

## Needles

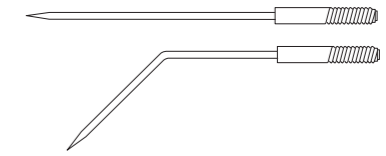

### Straight

Code	Description
SC-DIA/064	Stout
SC-DIA/064a	Medium

### Angled

Code	Description
SC-DIA/064b	Stout
SC-DIA/064c	Medium

## Diathermy Arm

With ball



Code	Description
SC-DIA/069	Curved
SC-DIA/069a	Straight

## Spatula Blade

For diathermy finger



Code
SC-DIA/067a

## Needle Point

For diathermy finger



Code
SC-DIA/067b

# Leads and Quivers

## Leads

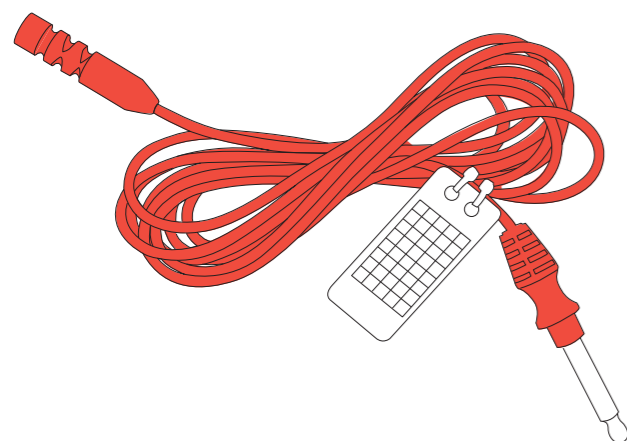

Code	Description
SC-DIA/065	4mm plug end
SC-DIA/066	8mm plug end

## Bipolar Leads

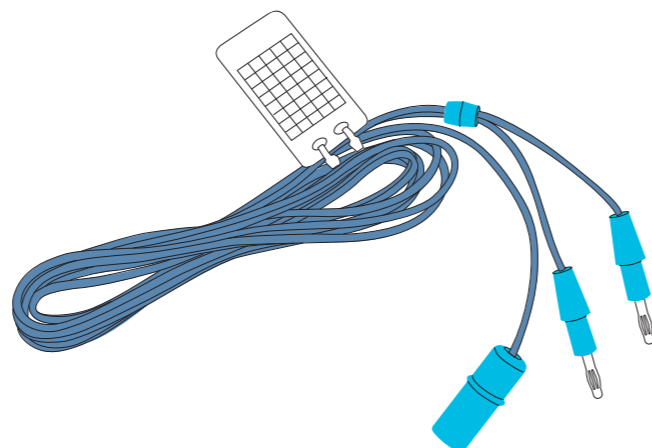

Code	Description
SC-DIA/067	Standard

## Quiver

With hole in end, 232mm long

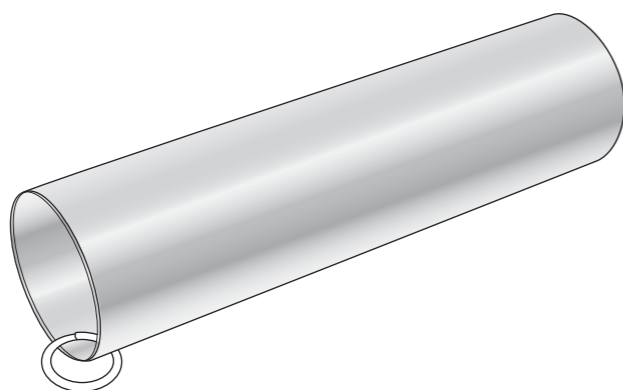

Code	Description
SC-DIA/001	Standard

## Quiver

With hole in end, 232mm long

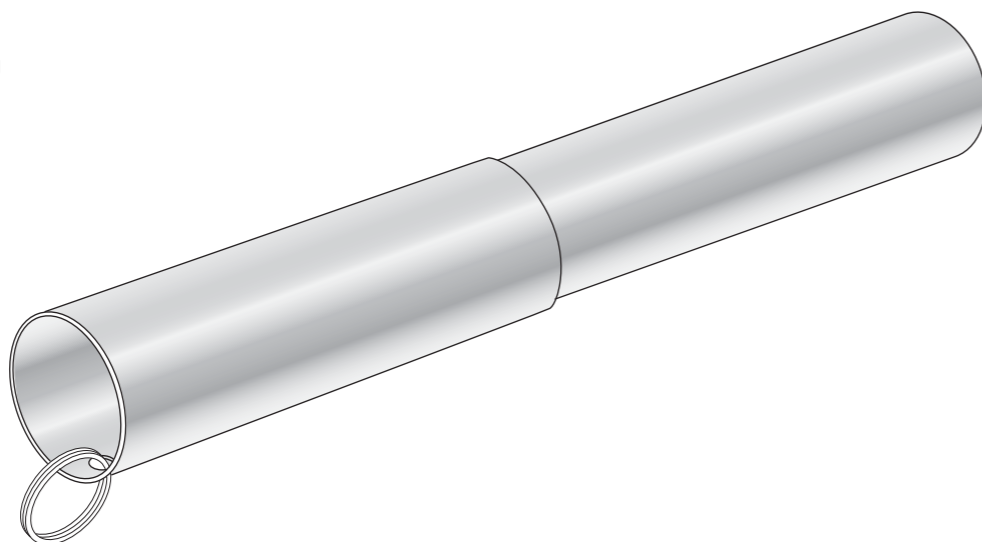

Code	Description
SC-DIA/002	Telescopic

# ENT

Middle Ear Instruments	60
Picks and Scoops	62
Hooks and Probes	63
Retractors	64
Suction Tubes	65
Speculum	66
Aural Forceps	68
Artery Forceps	70
Tonsil, Turbinate and Septum Forceps	71
Dressing Forceps	72
Other Forceps	73
Mouth Gags	74
Tongue Plates and Depressors	75
Punches	76
Rongeurs	80
Scissors	82
Gouges, Knives and Elevators	84
Curettes and Myringotomes	85
Elevators and Dissectors	86
Miscellaneous	87



# Middle Ear Instruments

## Ironside Instruments

160mm long, black finish

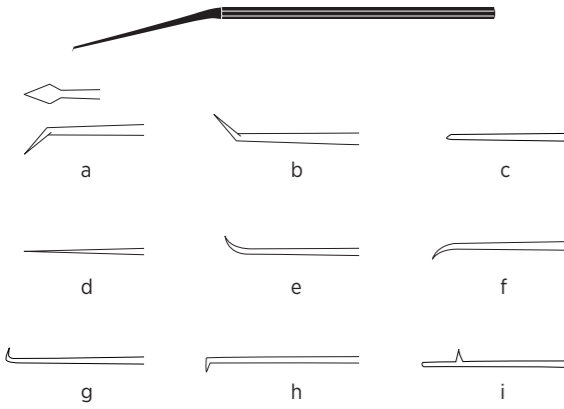

Code	Description
SC-ENT/200a	Knife 1, vertical incision
SC-ENT/200b	Knife 2, horizontal incision
SC-ENT/200c	Elevator
SC-ENT/200d	Needle point
SC-ENT/200e	Hook, superior elevation, angle 45°
SC-ENT/200f	Hook, inferior elevation, angle 45°
SC-ENT/200g	Hook, anterior elevation, angle 90° right
SC-ENT/200h	Hook, anterior elevation, angle 90° left
SC-ENT/200i	Measuring device

## Rosen Instruments

160mm long, black finish

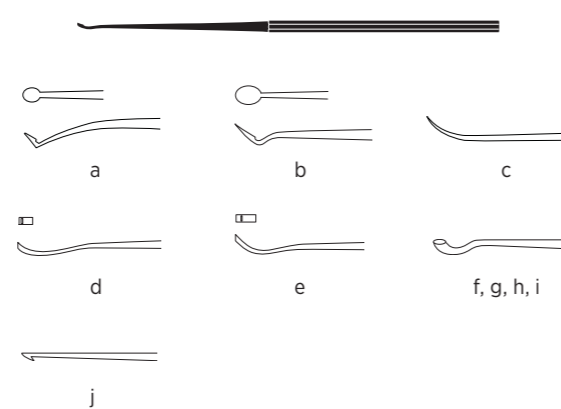

Code	Description
SC-ENT/202a	Curette, tympanic ring, small
SC-ENT/202b	Curette, tympanic ring, large
SC-ENT/202c	Probe, footplate movement test, fine
SC-ENT/202d	Mobiliser, slight curve
SC-ENT/202e	Mobiliser, full curve
SC-ENT/202f	Scoop, size 000
SC-ENT/202g	Scoop, size 00
SC-ENT/202h	Scoop, size 0
SC-ENT/202i	Scoop, size 1
SC-ENT/202j	Fenestrator, oval window

## Beale Instruments

170mm long, satin finish

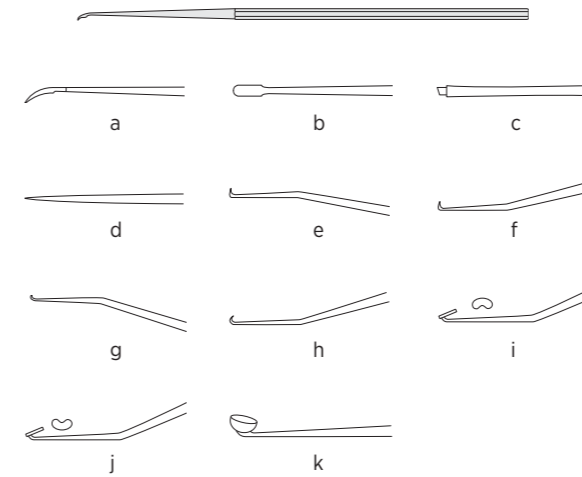

Code	Description
SC-ENT/203a	Knife, Stapedius tendon cutting
SC-ENT/203b	Raspatory, mucous removal
SC-ENT/203c	Osteotome, footplate
SC-ENT/203d	Perforator, elevation fixed footplate
SC-ENT/203e	Hook, removal of footplate, angled downward
SC-ENT/203f	Hook, removal of footplate, angled upward
SC-ENT/203g	Hook, bone removal from oval window, angled left
SC-ENT/203h	Applicator, vein graft for right ear
SC-ENT/203i	Applicator, vein graft for left ear
SC-ENT/203j	Curette, removal bony rim
SC-ENT/203k	Curette

# Middle Ear Instruments

## Hough Instruments

165mm long, stainless steel

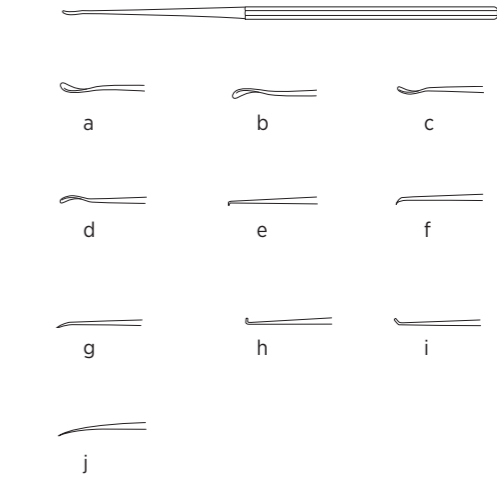

Code	Description
SC-ENT/205a	Excavator, "whirlybird", right, large
SC-ENT/205b	Excavator, "whirlybird", left, large
SC-ENT/205c	Excavator, "whirlybird", right, small
SC-ENT/205d	Excavator, "whirlybird", left, small
SC-ENT/205e	Pick, stapedectomy footplate, angled 90°, 0.33mm
SC-ENT/205f	Pick, stapedectomy footplate, angled 45°, 0.5mm
SC-ENT/205g	Pick, stapedectomy footplate, angled 15°, 0.5mm
SC-ENT/205h	Hook, "hoe", excavator, angled 90°
SC-ENT/205i	Hook, "hoe", excavator, angled 45°
SC-ENT/205j	Pick, curved

## Schuknecht Instruments

160mm long, black finish

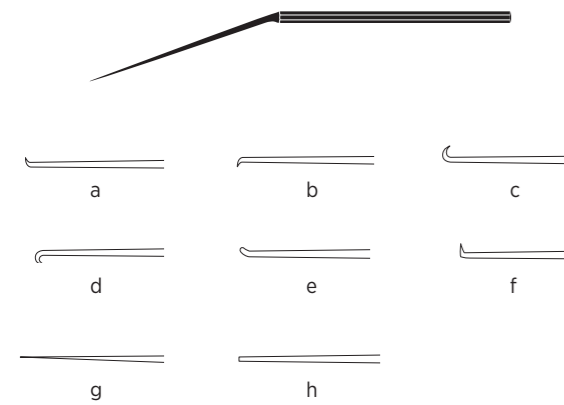

Code	Description
SC-ENT/201a	Hook upward, 0.4mm
SC-ENT/201b	Hook downward, 0.4mm
SC-ENT/201c	Hook upward, 0.7mm
SC-ENT/201d	Hook downward, 0.7mm
SC-ENT/201e	Elevator, oval
SC-ENT/201f	Hook, right-angled upward
SC-ENT/201g	Pick, straight
SC-ENT/201h	Spatula

## Beale Instruments

165mm long, satin finish

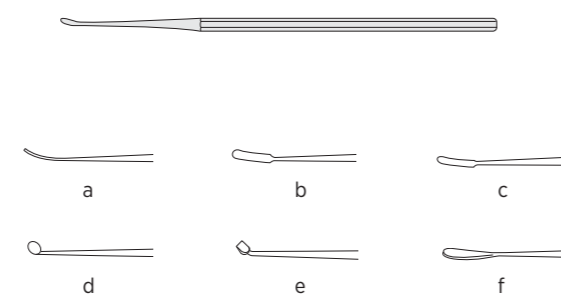

Code	Description
SC-ENT/204a	Tympanoplasty probe, fine blunt end
SC-ENT/204b	Raspatory, slight curve
SC-ENT/204c	Raspatory, slight curve, small
SC-ENT/204d	Rugine, double ended, sharp
SC-ENT/204e	Rugine, double ended
SC-ENT/204f	Spatula, graft smoothing

## Cawthorne Hooks

165mm long, black finish

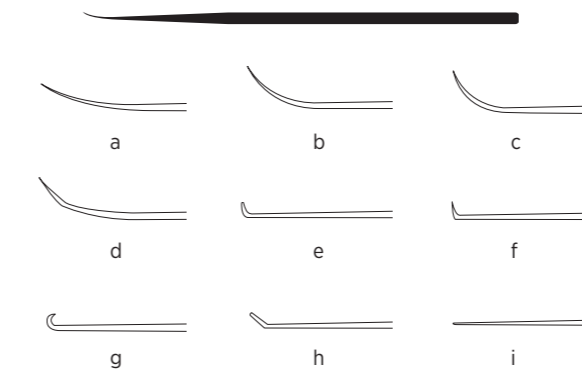

Code	Description
SC-ENT/206a	Slight curve
SC-ENT/206b	Medium curve
SC-ENT/206c	Full curve
SC-ENT/206d	Double curve
SC-ENT/206e	90° angle, 0.5mm
SC-ENT/206f	90° angle, 1.0mm
SC-ENT/206g	45° angle, 0.5mm
SC-ENT/206h	Retrograde
SC-ENT/206i	Straight

Protect your delicate ENT instruments with our custom baskets

Manufactured at our workshop in Essex

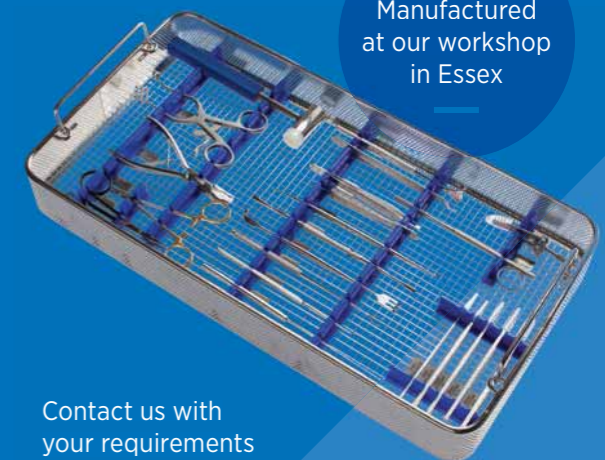

Contact us with your requirements

info@surgicalholdings.co.uk

# Picks and Scoops

## Musgrove Cerumen Pick and Wool Carrier

Double ended



Code	Description
SC-ENT/024	178mm long

## Formby Cerumen Scoop and Hook

Double ended

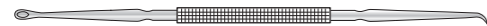

Code	Description
SC-ENT/026	178mm long

## Hovell Loop

Fine, for removing hard wax



Code	Description
SC-ENT/027	152mm long

## Lempert Scoop

Oval, 200mm long

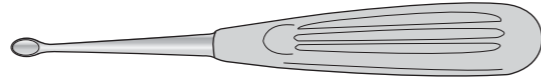

Code	Description
SC-ENT/066a	2mm x 2.5mm
SC-ENT/066b	2mm x 3.5mm
SC-ENT/066c	2mm x 4mm
SC-ENT/066d	2mm x 4.5mm
SC-ENT/066e	3mm x 5.5mm
SC-ENT/066f	3mm x 6mm

## House Curette

Double ended, 180mm long



Code	Description
SC-SH/5213	Straight
SC-SH/5213a	Angled

## Balance Scoop and Curette



Code	Description
SC-ENT/038	230mm long

# Hooks and Probes

## Hartmann Hook

Sharp, straight shaft



Code	Description
SC-ENT/021	140mm long

## Cawthorne Cerumen Hook

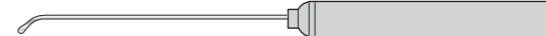

Code	Description
SC-ENT/023	143mm long

## Tracheal Hook

Sharp



Code	Description
SC-ENT/SH.5672	165mm long

## Tracheal Single Hook Retractor

Sharp



Code	Description
SC-GI/SH5671	152mm long

## Tracheal Double Hook

Blunt



Code	Description
SC-ENT/SH.5673	105mm long

## Gardiner Brown Hook and Imray Loop

Double ended



Code	Description
SC-ENT/025	127mm long

## St Bart's Hook

Blunt, straight handle

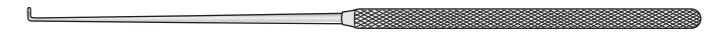

Code	Description
SC-ENT/022	178mm long

## McIndoe Skin Hook

Fine, with flat handle



Code	Description
SC-ENT/057	191mm long

## Cawthorne Probe

Silver, flattened end



Code	Description
SC-ENT/019	140mm long

## Jobson Horne Probe

Double ended, serrated tip and smooth ring



Code	Description
SC-ENT/020a	140mm long
SC-ENT/020b	178mm long



# Retractors

## Mollison Retractor

Self retaining, curved

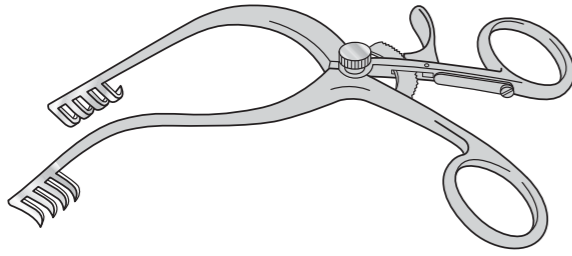

Code	Description
SC-ENT/034a	4-4 teeth, adult, 165mm long
SC-ENT/034b	2-2 teeth, child, 133mm long

## Plester-Jansen Retractor

Solid blade one side, 140mm long

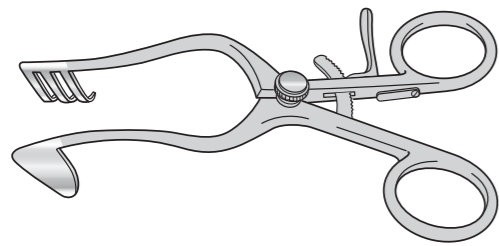

Code	Description
Sc-Ent/061A	Left
Sc-Ent/061B	Right
Sc-Ent/061C	3 x 3 Teeth

## Hurd Pillar Retractor and Tonsil Dissector



Code	Description
SC-ENT/147	197mm long

## Wallace Modified Plester Retractor

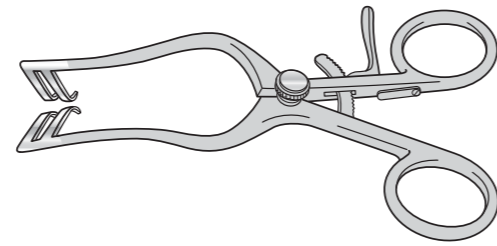

Code	Description
SC-ENT/062	2 x 2 teeth, 140mm long

## Shah Intra Aural Retractor

Satin finish 152mm long

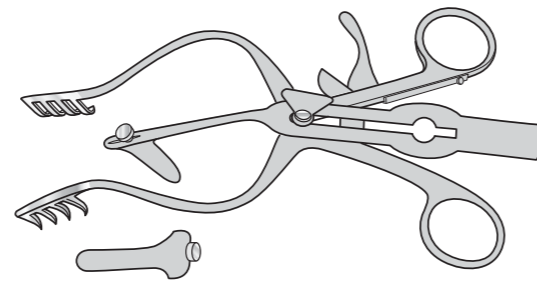

Code	Description
SC-ENT/060a	4-4 teeth, adult, 165mm long
SC-ENT/060b	Third blade
SC-ENT/060c	Intra aural blade
SC-ENT/060d	Post aural blade

## Mollison Anterior Pillar Retractor and Tonsil Enucleator

Semi sharp



Code	Description
SC-ENT/148	210mm long

# Suction Tubes

## Ipswich Pattern Sucker



Code	Description
SC-ENT/050a	267mm long

## Formby Suction Tube

Angled, conical, tip size 10 F.G. stainless steel

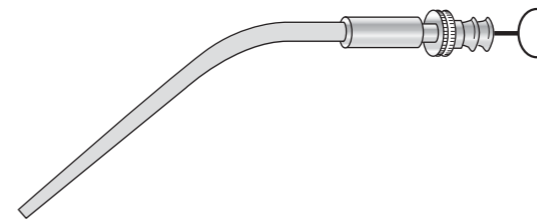

Code	Description
SC-ENT/042	210mm long

## Barron Suction Tube

Small size, 4 F.G. Not for use with Zoellner ends

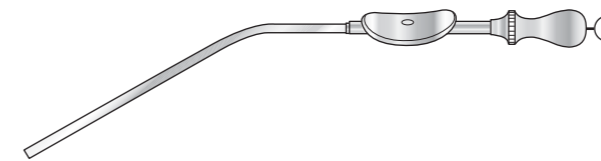

Code	Description
SC-ENT/041	229mm long

## House Suction and Irrigation Tubes

Stainless steel, 152mm long

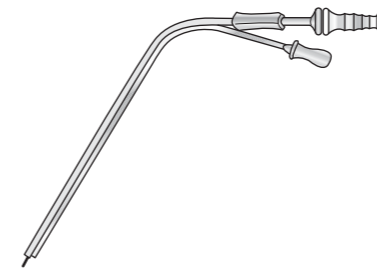

Code	Description
SC-ENT/043	8 F.G. x 6 F.G.
SC-ENT/043a	10 F.G. x 7 F.G.
SC-ENT/043b	12 F.G. x 8 F.G.

## Lempert Suction and Irrigation Tubes

With tucker valve and stilette for cleaning stainless steel, 203mm



Code	Description
SC-ENT/044	6 F.G. 2mm
SC-ENT/044a	9 F.G. 3mm

## Magill Suction Tubes

Set of four with conical ends, one curved, three angled, handle, stainless steel, 210mm



Code	Description
SC-ENT/045	Various sizes
SC-ENT/046a	3.0mm ø
SC-ENT/046b	3.5mm ø
SC-ENT/046c	4.0mm ø

## Zoellner Suction Tube

With stilette, stainless steel

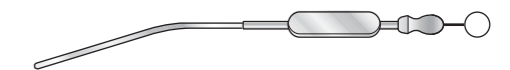

Code	Description
SC-ENT/047	170mm long, 2mm ø

## Rowbotham Suction Tube

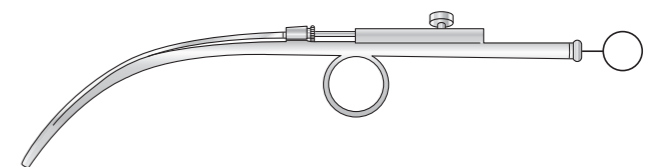

Code	Description
SC-ENT/169	286mm long

## Rosen Slotted Speculum

Set of four, round ends, black finish  
38mm long

Code	Description
SC-ENT/049j	Set of 4
SC-ENT/049f	4mm
SC-ENT/049g	5mm
SC-ENT/049h	6mm
SC-ENT/049i	7mm

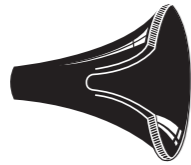

## Tumarkin Speculum

Set of eight, tapered slot, black finish  
50mm long

Code	Description
SC-ENT/052	Set of 8
SC-ENT/053a	4.5mm ø
SC-ENT/053b	6.5mm ø
SC-ENT/053c	7.0mm ø
SC-ENT/053d	7.5mm ø
SC-ENT/053e	8.0mm ø
SC-ENT/053f	8.5mm ø
SC-ENT/053g	9.0mm ø
SC-ENT/053h	11.0mm ø

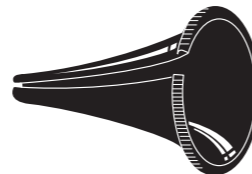

## Rosen Aural Speculum

Round, 40mm long

Code	Description
SC-ENT/049a	3mm
SC-ENT/049b	4mm
SC-ENT/049c	5mm
SC-ENT/049d	6mm
SC-ENT/049e	7mm



## Heath Speculum

Set of four, black finish  
50mm long

Code	Description
SC-ENT/207e	Set of 4
SC-ENT/207a	4.0mm ø
SC-ENT/207b	5.0mm ø
SC-ENT/207c	6.0mm ø
SC-ENT/207d	7.0mm ø



## Shea Speculum

Set of five, oblique ends, black finish, 38mm long

Code	Description
SC-ENT/050	Set of 5
SC-ENT/051	3mm
SC-ENT/051a	4mm
SC-ENT/051b	5mm
SC-ENT/051c	6mm
SC-ENT/051d	7mm



## Peters Seigle Speculum

Code	Description
SC-ENT/366	Peters ear speculum black chrome finish set of 5, sizes 0 to 4
SC-ENT/189i	2.2mm x 3.2mm
SC-ENT/189j	2.8mm x 4.2mm
SC-ENT/189k	4.3mm x 5.8mm
SC-ENT/189l	5.2mm x 7.6mm
SC-ENT/189m	6.0mm x 7.6mm
SC-ENT/189d	6mm
SC-ENT/189e	7mm
SC-ENT/189f	8mm
SC-ENT/189g	9mm
SC-ENT/189h	10mm

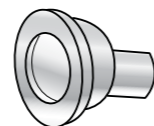

## St Clair Thompson Nasal Speculum

Code	Description
SC-ENT/072	38mm long
SC-ENT/072a	51mm long
SC-ENT/072b	64mm long
SC-ENT/072c	89mm long

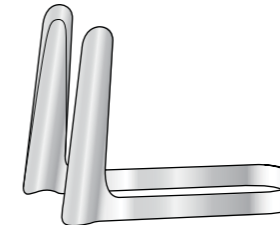

## Thudichum Nasal Speculum

Set of seven, sizes 1-7,  
70mm long

Code	Description
SC-ENT/073a	Standard
SC-ENT/073b	Insulated

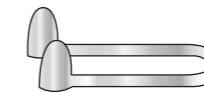

### Standard

Code	Description
SC-ENT/073a	Size 1 - 12mm blade
SC-ENT/073a	Size 2 - 14mm blade
SC-ENT/073a	Size 3 - 16mm blade
SC-ENT/073a	Size 4 - 18mm blade
SC-ENT/073a	Size 5 - 20mm blade
SC-ENT/073a	Size 6 - 22mm blade
SC-ENT/073a	Size 7 - 24mm blade
SC-ENT/073a	Size 8 - 27mm blade

### Insulated

Code	Description
SC-ENT/073b	Size 1 - 12mm blade
SC-ENT/073b	Size 2 - 14mm blade
SC-ENT/073b	Size 3 - 16mm blade
SC-ENT/073b	Size 4 - 18mm blade
SC-ENT/073b	Size 5 - 20mm blade
SC-ENT/073b	Size 6 - 22mm blade
SC-ENT/073b	Size 7 - 24mm blade
SC-ENT/073b	Size 8 - 27mm blade

## Killian Nasal Speculum

### With Stop

Code	Description
SC-ENT/081a	51mm blade
SC-ENT/081b	64mm blade
SC-ENT/081c	76mm blade
SC-ENT/081d	89mm blade

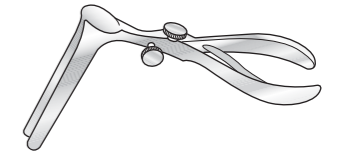

### Without Stop

Code	Description
SC-ENT/082b	76mm blade

## Lempert Endaural Speculum

Code	Description
SC-ENT/060e	133mm long



## Pilcher Nasal Speculum

Code	Description
SC-ENT/071	152mm

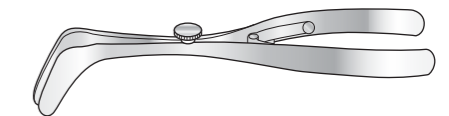

## Cottle Nasal Speculum

127mm long

Code	Description
SC-ENT/192c	20mm blade
SC-ENT/192b	32mm blade
SC-ENT/192	41mm blade
SC-ENT/192a	60mm blade

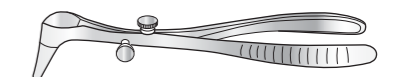

Consistent quality across  
all our instruments



Did you know...

Surgical Holdings have patterns and drawings to ensure their instruments are consistent in design and finish for end users.

+  
We also  
work to British  
Standard  
BS 5194

Get in touch to discuss your instrument requirements at [info@surgicalholdings.co.uk](mailto:info@surgicalholdings.co.uk)

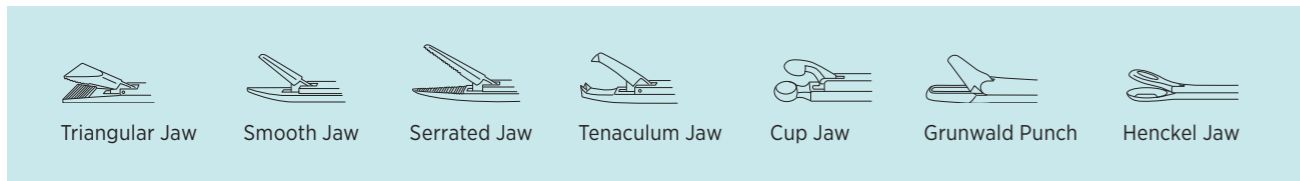

## Beale Aural Forceps

Micro, black finish, triangular flat jaws, serrated



Code	Description
SC-ENT/183	70mm to shoulder

## Hough Aural Forceps

Micro, extra fine oval cup jaws, black finish



Code	Description
SC-ENT/059	70mm to shoulder

## Cawthorne Aural Forceps

Micro, black finish, extra fine  
70mm to shoulder



Code	Description
SC-ENT/182	Smooth jaws
SC-ENT/199	Serrated jaws

## Ormerod Aural Forceps

Micro, extra fine, black finish  
70mm to shoulder



Code	Description
SC-ENT/184a	Serrated, angled upwards
SC-ENT/184b	1mm cup jaw
SC-ENT/184c	Elongated cup jaw, 0.5 x 4mm

## Hartmann Aural Forceps

Micro, black finish  
75mm to shoulder

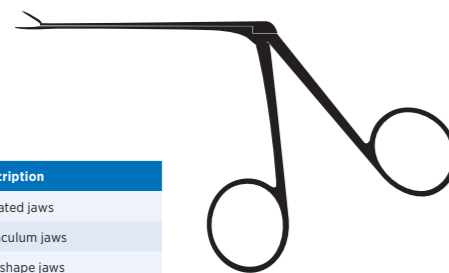

Code	Description
SC-ENT/058	Serrated jaws
SC-ENT/058a	Tenaculum jaws
SC-ENT/058b	Cup shape jaws
SC-ENT/058c	Curved left, serrated
SC-ENT/058d	Curved right, serrated
SC-ENT/058e	Angled up, serrated
SC-ENT/058f	Serrated jaws, satin finish
SC-ENT/058s	Pre-sterile - single use only

## Shea Aural Forceps

Micro, oval cup jaw, black finish  
70mm to shoulder



Code	Description
SC-ENT/069	Standard
SC-ENT/069a	Curved to left
SC-ENT/069b	Curved to right
SC-ENT/069c	Curved upward

## Hartmann Aural Forceps

Standard, satin finish  
75mm to shoulder

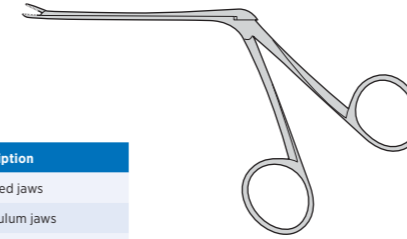

Code	Description
SC-ENT/181	Serrated jaws
SC-ENT/181a	Tenaculum jaws
SC-ENT/181b	Cup shape jaws
SC-ENT/181c	Grunwald punch action

## Heath Aural Forceps

Light, with lifting discs, serrated jaws

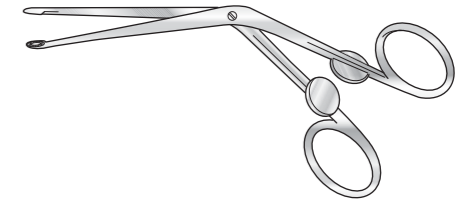

Code	Description
SC-ENT/175	83mm to shoulder

## Henckel Aural Forceps

Fine fenestrated scoop blades

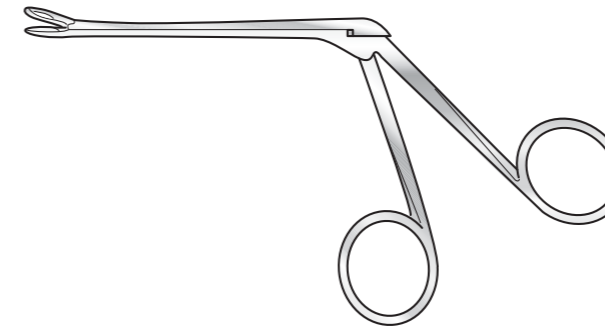

Code	Description
SC-ENT/176	75mm to shoulder

## Struycken Cutting Forceps

75mm to shoulder

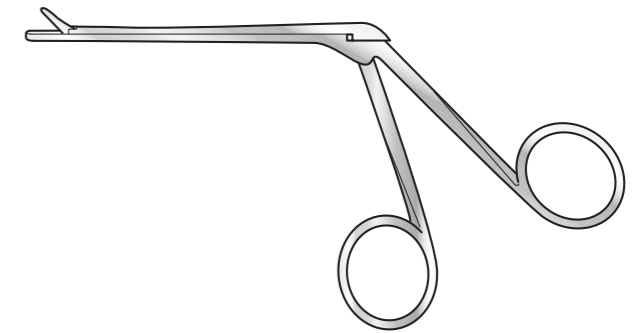

Code	Description
SC-ENT/178	Fenestrated under jaw

Did you know...

**We can repair delicate ENT instruments**

Our technicians manufacture instruments from scratch, so they have the skills and experience needed to repair even the most delicate instruments.

Get in touch to book a repair  
[info@surgicalholdings.co.uk](mailto:info@surgicalholdings.co.uk)

# Artery Forceps

## Birkett Tonsil Artery Forceps

Fine, 178mm long

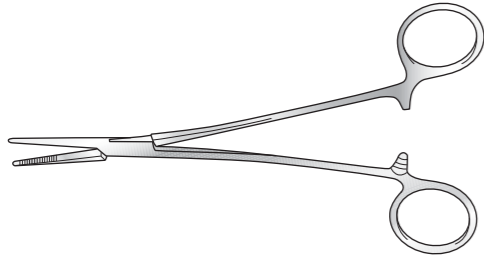

Code	Description
SC-ENT/151a	Straight
SC-ENT/151b	Curved

## Negus Tonsil Artery Forceps

180mm long

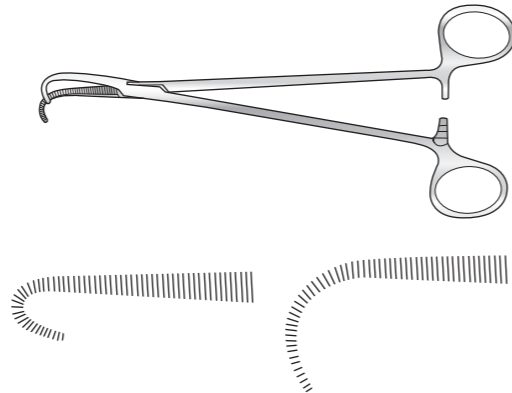

Code	Description
SC-ENT/197	Large curve
SC-ENT/197a	Small curve

## Denis Browne Tonsil Artery Forceps

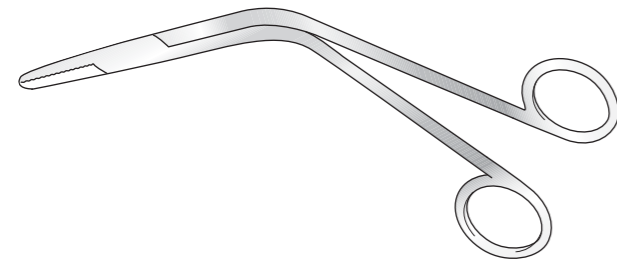

Code	Description
SC-ENT/155	216mm long

## Sawtell Tonsil Artery Forceps

178mm long

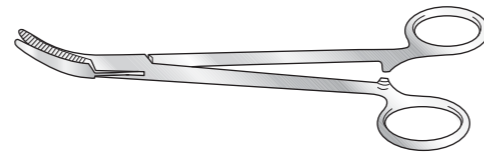

Code	Description
SC-ENT/152	Large curve
SC-ENT/153	Small curve

## Fickling Artery Forceps

190mm long

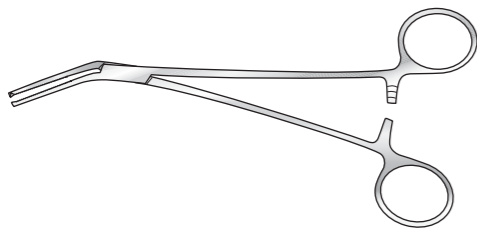

Code	Description
SC-PL/044b	1-2 teeth
SC-PL/044a	Serrated

## Scott Tonsil Artery Forceps

Curved to side, screw joint

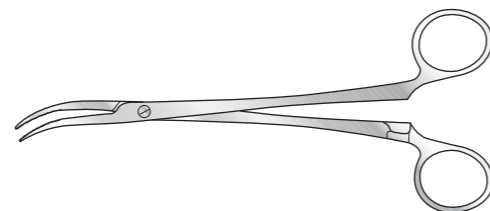

Code	Description
SC-ENT/154	180mm long

# Tonsil, Turbinate and Septum Forceps

## Denis Browne Tonsil Holding Forceps

Angled shanks, no rack

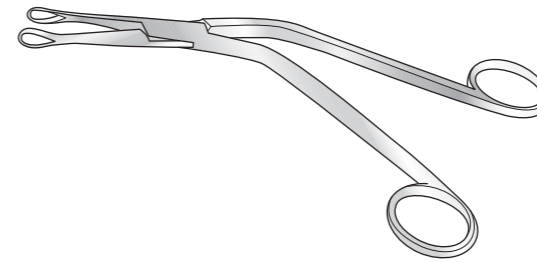

Code	Description
SC-ENT/144	200mm long

## Jansen-Middleton Nasal Septum Forceps

Compound action  
178mm long

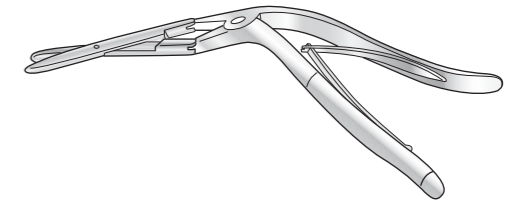

Code	Description
SC-PL/032	5mm jaw

## Irwin Moore Nasal Turbinate Forceps

191mm long

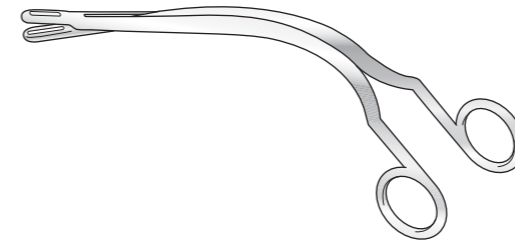

Code	Description
SC-ENT/077d	5mm jaw

## Walsham Septum Forceps

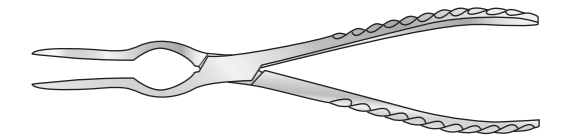

Code	Description
SC-PL/030a	Straight, 215mm long
SC-PL/030b	Right, 215mm long
SC-PL/030c	Left, 215mm long

## Luc Nasal Turbinate Forceps

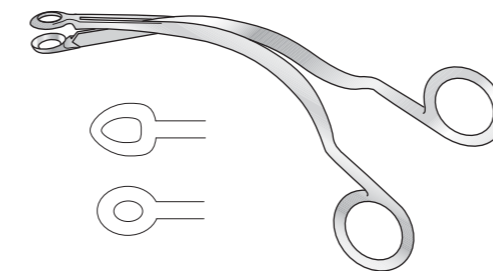

### Heart shaped, 178mm long

Code	Description
SC-ENT/078a	Small 6mm ø
SC-ENT/078b	Medium 7.5mm ø
SC-ENT/078c	Large 9.0mm ø

### Oval, 191mm long

Code	Description
SC-ENT/078d	Small 6mm ø
SC-ENT/078e	Medium 7.5mm ø
SC-ENT/078f	Large 9.0mm ø

## Hartmann Conchotomes

Circular cutting  
102mm to shoulder

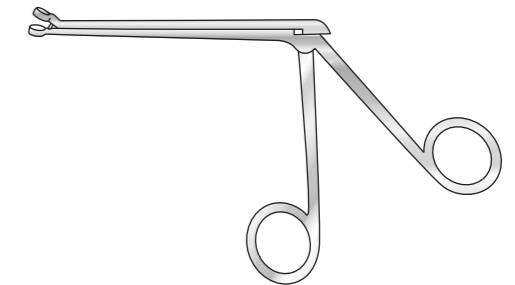

Code	Description
SC-ENT/080a	5mm ø
SC-ENT/080b	7mm ø
SC-ENT/080c	9mm ø
SC-ENT/080d	11mm ø

# Dressing Forceps

## Hartmann Dressing Forceps

Serrated jaw, screw joint

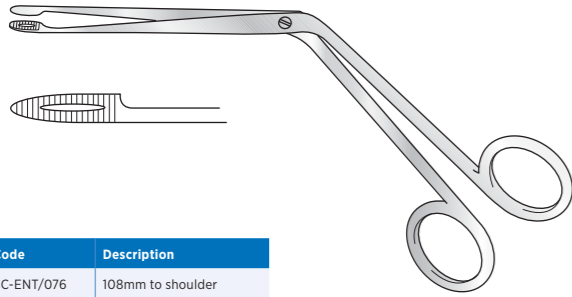

Code	Description
SC-ENT/076	108mm to shoulder

## Wilde Dressing Forceps

Angular, serrated jaws

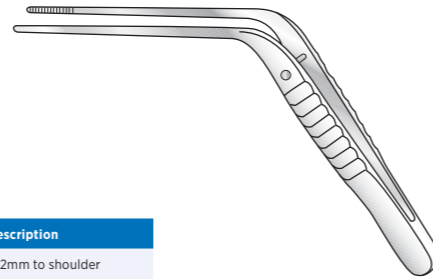

Code	Description
SC-ENT/075	102mm to shoulder

## Tilley Dressing Forceps

Straight, fine, serrated ends

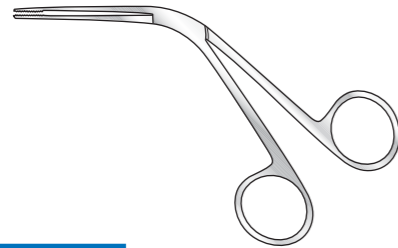

Code	Description
SC-ENT/077	2mm wide, 76mm to shoulder

## Irwin Moore Thyroid Clamp

Thin jaws, angled to side

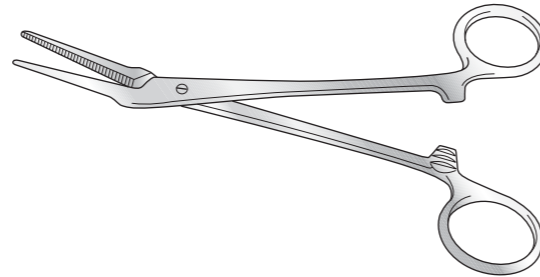

Code	Description
SC-ENT/170	165mm long

## Trousseau Tracheal Dilator

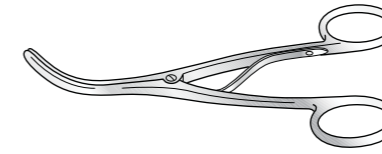

Code	Description
SC-ENT/172	Adult 140mm long
SC-ENT/172a	Child 125mm long

## Cawthorne Nibbling Forceps

Narrow, 3mm jaws, wide handle

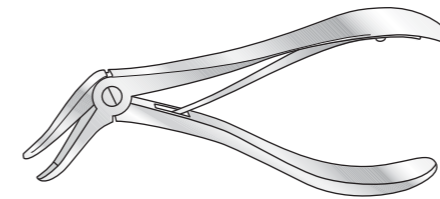

Code	Description
SC-ENT/068	159mm long

## Wilson Bone Nibbling Forceps

Fine, curved, satin finish  
152mm long

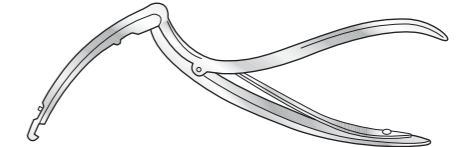

Code	Description
SC-ENT/054	Downward cutting - 3mm jaws
SC-ENT/055	Upward cutting - 3mm jaws

## Denis Browne Collar Crushing Forceps

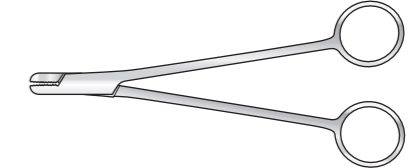

Code	Description
SH-4062	140mm long

## Lempert Nibbling Forceps

152mm long



Code	Description
SC-ENT/067a	Straight, 2.5mm jaws
SC-ENT/067b	Angled, 3.0mm jaws



## Secto® Dissectors

Designed to provide a gentle, atraumatic way to separate tissue during surgical procedures. These sterile, cotton-constructed dissectors are x-ray detectable and available in four patterns: Cherry, Triangle, Peanut and Kittner.



Secto® Cherry Dissectors



Secto® Triangle Dissectors



Secto® Peanut Dissectors



Secto® Kittner Dissectors

## Secto® Tonsil Sponges

Sterile, cotton, non-linting, x-ray detectable gauzes with identification tape and string for use during tonsillectomies.



Secto® Tonsil Sponges



Ideal for laparoscopic use

Contact us with your requirements [info@surgicalholdings.co.uk](mailto:info@surgicalholdings.co.uk)

# Mouth Gags

## Doyen Mouth Gag

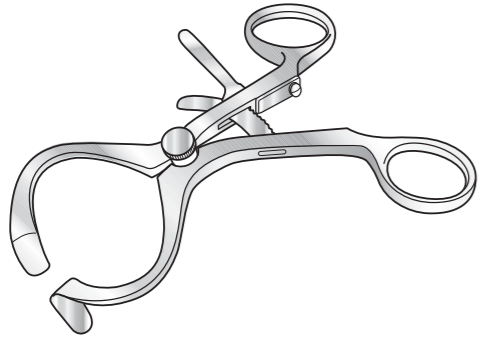

Code	Description
SC-ENT/88d	Adult
SC-ENT/88e	Child

## Boyle-Davis Mouth Gag

Frame only

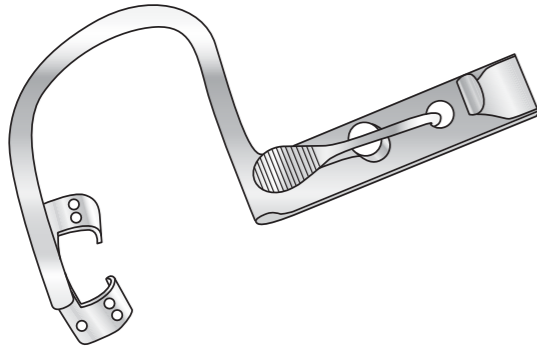

Code	Description
SC-ENT/083a	Adult
SC-ENT/083b	Child

## Kilner Dott Mouth Gag

Frame only

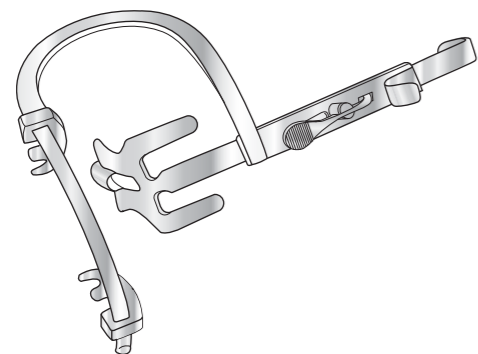

Code	Description
SC-ENT/087a	Adult
SC-ENT/088e	Set, including frame, small, medium, and large blades

## Fergusson Ackland Mouth Gag

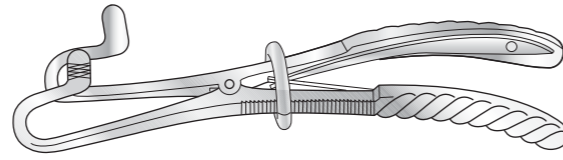

Code	Description
SC-ENT/209	Adult, 210mm
SC-ENT/209a	Child, 155mm

## Mason Mouth Gag

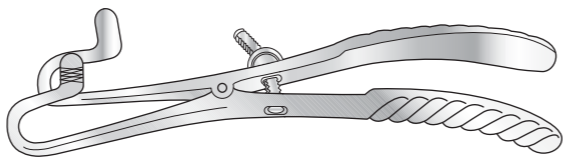

Code	Description
SC-ENT/210	Adult, 210mm

## Draffin Bipod

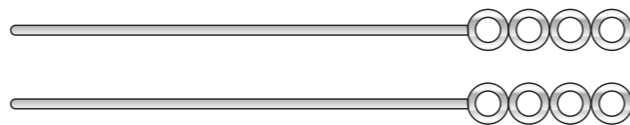

### Adult

Code	Description
SC-ENT/083	Adult, 4 hole x 480mm long half circle end for use with a drape
SC-ENT/083E	Adult, 4 hole x 480mm long with round ends to be used with Magauran plate
SC-ENT/083E	Adult, 4 hole x 480mm long with round ends to be used with Magauran plate

### Child

Code	Description
SC-ENT/083C	Child, 3 hole x 425mm long half circle end for use with a drape
SC-ENT/083D	Child, 3 hole x 425mm long with round ends to be used with Magauran plate
SC-ENT/083F	Child, 4 hole x 425mm long with round ends to be used with Magauran plate Alder Hey Children's Hospital pattern
SC-ENT/083D	Child, 3 hole x 425mm long with round ends to be used with Magauran plate
SC-ENT/083F	Child, 4 hole x 425mm long with round ends to be used with Magauran plate Alder Hey Children's Hospital pattern
SH-5104	Magauran plate 480mm - for use with Draffin bipods

### Magauran Plate

Code	Description
SH-5104	480mm - for use with Draffin bipods

# Tongue Plates and Depressors

## Doughty Tongue Plate

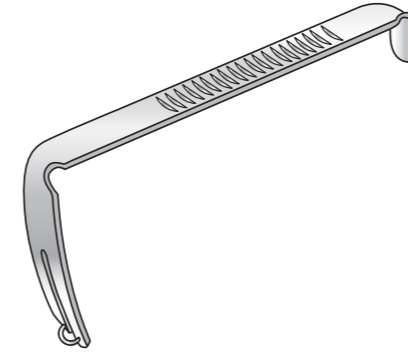

### Plain

Code	Description
SC-ENT/084a	65mm - 1.6mm-1.9mm slot
SC-ENT/084b	75mm - 1.6mm-1.9mm slot
SC-ENT/084c	90mm - 4mm-4.5mm slot
SC-ENT/084d	100mm - 4mm-4.5mm slot
SC-ENT/084e	115mm - 4mm-4.5mm slot

### Slotted

Code	Description
SC-ENT/085a	65mm - 1.6mm-1.9mm slot
SC-ENT/085b	75mm - 1.6mm-1.9mm slot
SC-ENT/085c	90mm - 4mm-4.5mm slot
SC-ENT/085d	100mm - 4mm-4.5mm slot
SC-ENT/085e	115mm - 4mm-4.5mm slot

### With anaesthetic tube

Code	Description
SC-ENT/086a	65mm - 1.6mm-1.9mm slot
SC-ENT/086b	75mm - 1.6mm-1.9mm slot
SC-ENT/086c	90mm - 4mm-4.5mm slot
SC-ENT/086d	100mm - 4mm-4.5mm slot
SC-ENT/086e	115mm - 4mm-4.5mm slot

## Kilner Dott Tongue Plate

With endotracheal tube groove

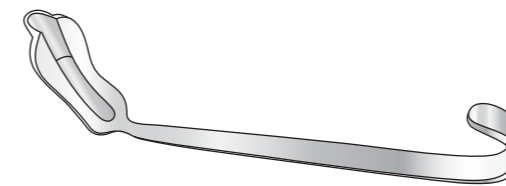

Code	Description
SC-ENT/088a	Small
SC-ENT/088b	Medium
SC-ENT/088c	Large
SC-ENT/088d	Extra small

## Tongue Depressor

Flat stainless steel



Code	Description
SC-ENT/143	184mm long

## Lack Tongue Depressor

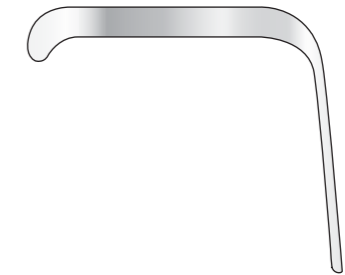

Code	Description
SC-ENT/142a	Child, 13mm wide
SC-ENT/142b	Adolescent, 19mm wide
SC-ENT/142c	Adult, 22mm wide

Nasal Cutting Forceps

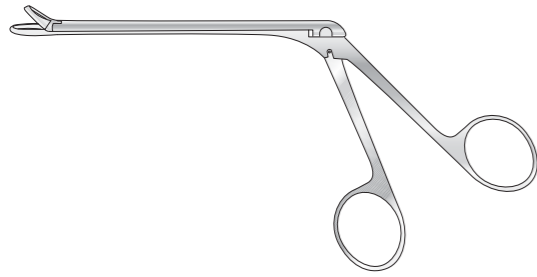

Myles

Through cutting, 120mm to shoulder

Code	Description
SC-ENT/SH5889	12.5 x 3.5mm jaw

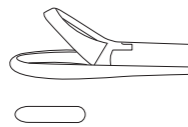

Gruenwald-Henke

Through cutting, 120mm to shoulder

Code	Description
SC-ENT/SH5281	7 x 2mm jaw
SC-ENT/SH5282	9 x 2.5mm jaw

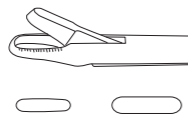

Struycken

Through cutting, 120mm to shoulder

Code	Description
SC-ENT/SH5280	11 x 1mm jaw

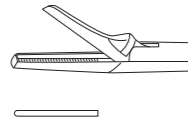

Grunwald Nasal Punch Forceps

108mm to shoulder

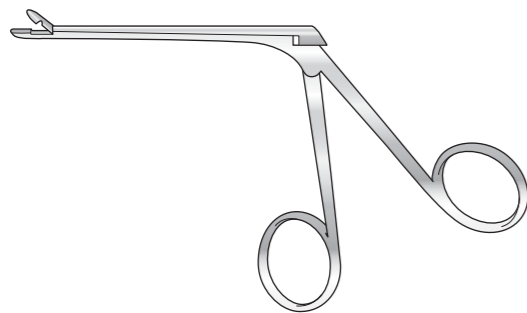

Code	Description
SC-ENT/077a	A fenestrated jaw, 3.5mm
SC-ENT/077b	Fenestrated lower jaw, narrow, 2.5mm
SC-ENT/077c	Fenestrated and tapered lower jaw, 2-3mm

Seymour Jones Antrum Punch Forceps

159mm long

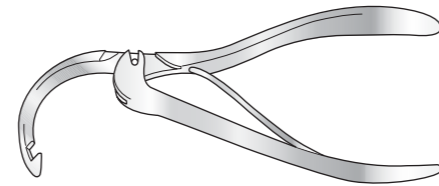

Code	Description
SC-ENT/132	4mm jaw

Backbiter

180mm long

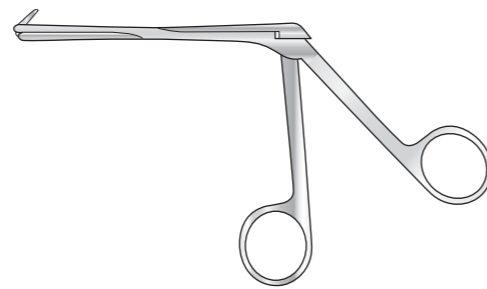

Code	Description
SH/4765b	7 x 3mm jaw

Backbiter

200mm long

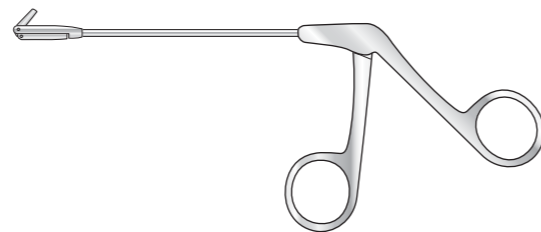

Code	Description
SC-ENT/5392	7 x 2mm jaw

Stammberger Rhinoforcep Antrium Punch

7mm x 3mm, 130mm long

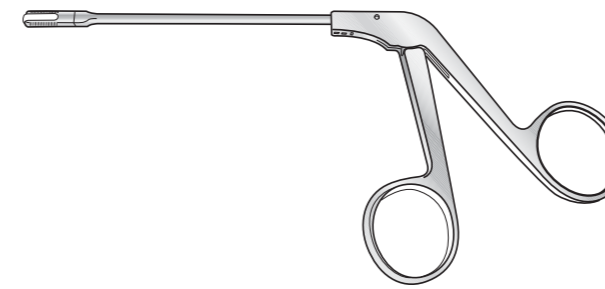

Code	Description
SC-ENT/234	Left back cut
SC-ENT/234a	Right back cut

Ostrom Antrum Punch

Forcep, 178mm to shoulder

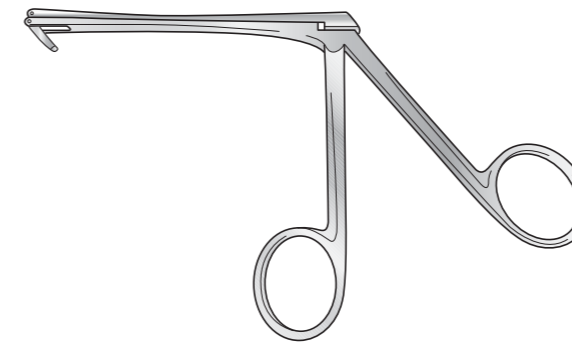

Code	Description
SC-ENT/135	3mm jaw

Tilley Henckel Ethmoid Punch

Graduated shank, 114mm to shoulder

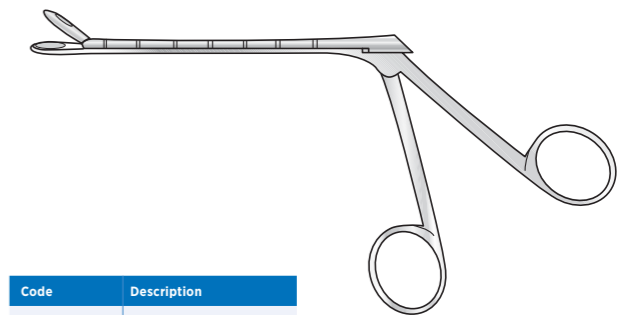

Code	Description
SC-ENT/138a	4.5mm
SC-ENT/138b	5.5mm
SC-ENT/138c	6.5mm
SC-ENT/138d	8mm

Mackay Modified Stammberger Punch

200mm long

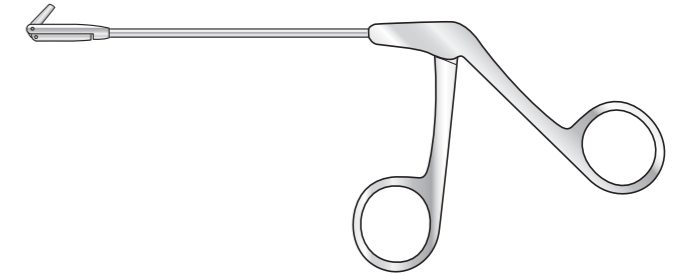

Code	Description
SC-ENT/5392	7 x 2mm jaw

Paterson Biopsy Forceps

Elongated cup, 3mm jaw



Code	Description
SC-ENT/174a	305mm long
SC-ENT/174b	355mm long
SC-ENT/174c	406mm long
SC-ENT/174d	508mm long

**Chevalier Jackson Endoscope Forcep**

With crocodile action and serrated jaw

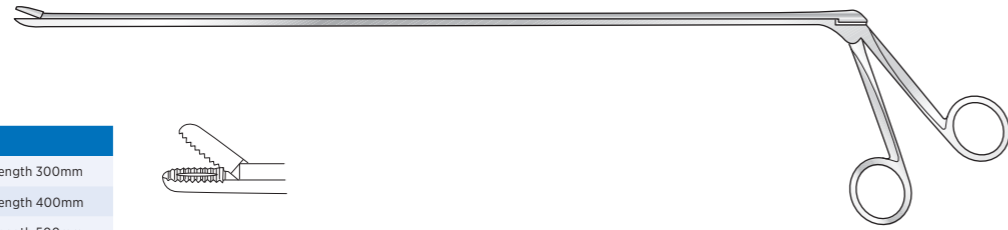

Code	Description
SC-ENT/241	Effective shaft length 300mm
SC-ENT/242	Effective shaft length 400mm
SC-ENT/243	Effective shaft length 500mm
SC-ENT/244	Effective shaft length 600mm

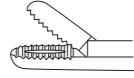

**Chevalier Jackson Vocal Nodule Endoscope Forcep**

With crocodile action and curved cup

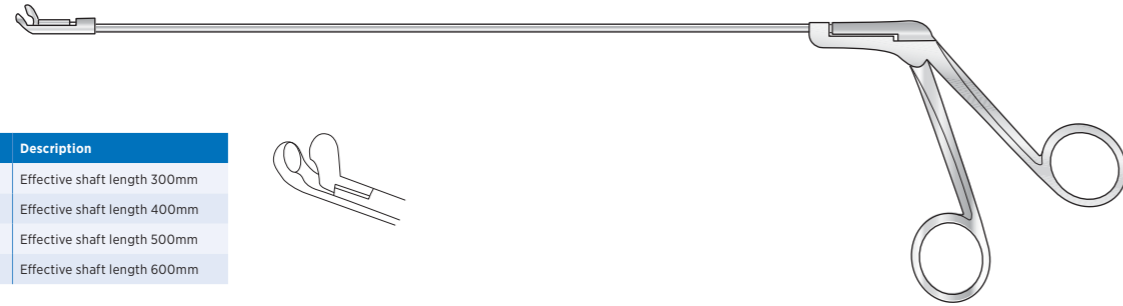

Code	Description
SC-ENT/245	Effective shaft length 300mm
SC-ENT/246	Effective shaft length 400mm
SC-ENT/247	Effective shaft length 500mm
SC-ENT/248	Effective shaft length 600mm

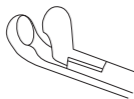

**Chevalier Jackson Vocal Nodule Endoscope Forcep**

With crocodile action and straight cup



Code	Description
SC-ENT/249	Effective shaft length 300mm
SC-ENT/250	Effective shaft length 400mm
SC-ENT/251	Effective shaft length 500mm
SC-ENT/252	Effective shaft length 600mm

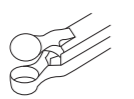

**St Bartholomew's Ethmoid Punch**

Scoop blades, 3mm bite, 114mm to shoulder

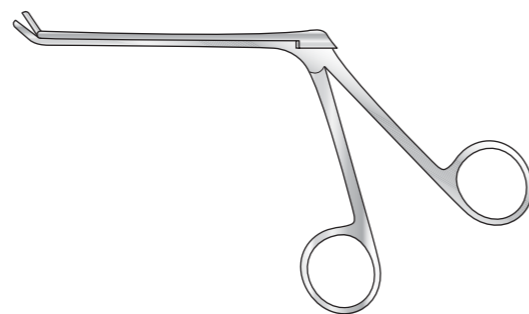

Code	Description
SC-ENT/140a	Straight
SC-ENT/140b	Upward cutting
SC-ENT/140c	Downward cutting

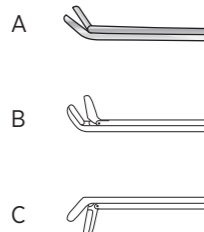

**Ferris Smith Kerrison Punch**

Heavy, 5mm bite, 229mm long

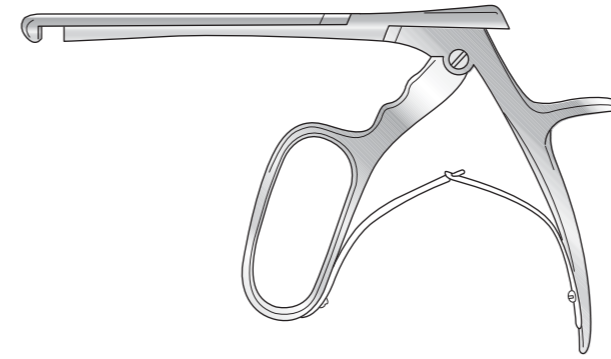

Code	Description
SC-ENT/137a	Upward cutting
SC-ENT/137B	Downward cutting

**Citelli Antrum Punch**

76mm to shoulder

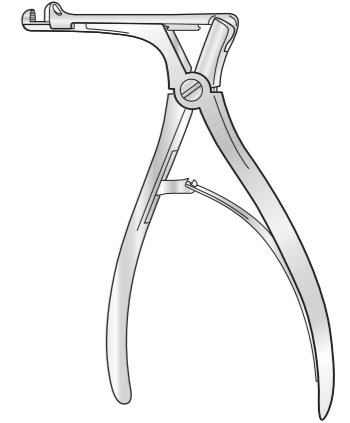

Code	Description
SC-ENT/133a	3mm jaw
SC-ENT/133b	5mm jaw

**Hajek Antrum Punch**

197mm long

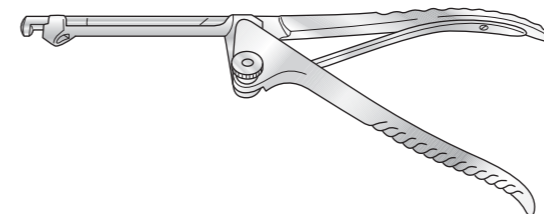

Code	Description
SC-ENT/134	5mm jaw

**Hajek Sphenoidal Punch**

146mm to shoulder

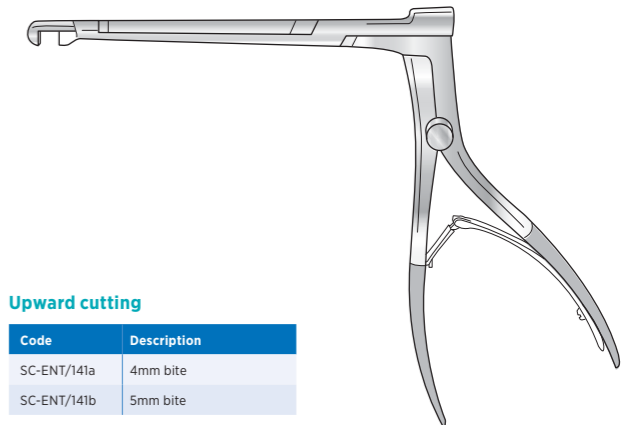

**Upward cutting**

Code	Description
SC-ENT/141a	4mm bite
SC-ENT/141b	5mm bite

**Downward cutting**

Code	Description
SC-ENT/141c	4mm bite
SC-ENT/141d	5mm bite



## Beck Rongeur

Straight, for intervertebral disc

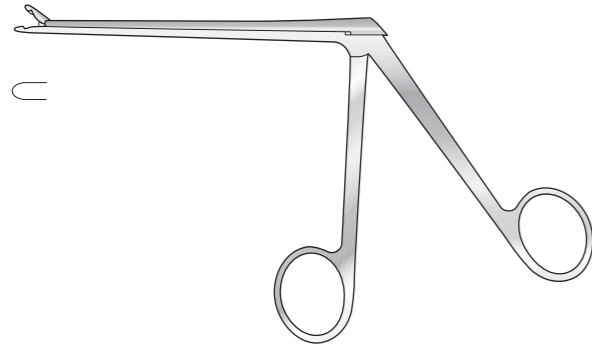

Code	Description
SC-NEU/125	2mm bite, 130mm shaft

## Pennybacker Rongeur

120mm shaft

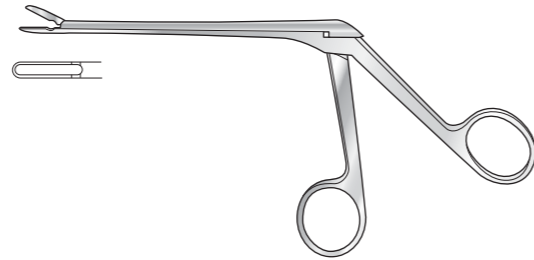

Code	Description
SC-NEU/133	3mm bite
SC-NEU/107	4mm bite

## Mackay Rongeur

140°, straight, 114mm shaft

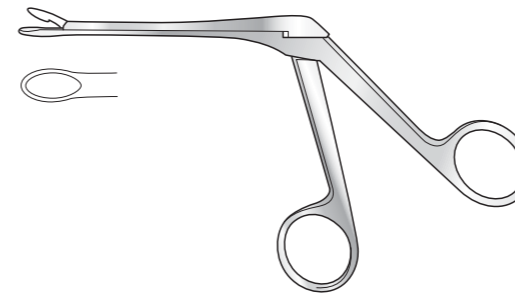

Code	Description
SC-SH/4249	5.5mm

## Weil-Blakesley Rongeur

110mm shaft

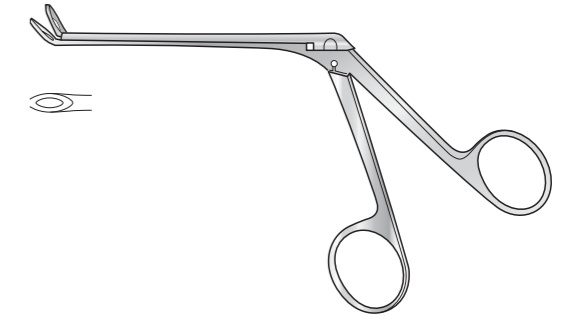

### 140° upward cutting

Code	Description
SC-ENT/194b	3.6mm bite
SC-ENT/194e	4.2mm bite
SC-ENT/194f	4.8mm bite

### 140° downward cutting

Code	Description
SC-ENT/194g	3.6mm bite
SC-ENT/194h	4.2mm bite
SC-ENT/194i	4.8mm bite

## Cushing Rongeur

130mm shaft



Code	Description
SC-NEU/127-2	2mm bite
SC-NEU/127-3	3mm bite
SC-NEU/127-4	4mm bite
SC-NEU/127-5	5mm bite
SC-NEU/127-6	6mm bite

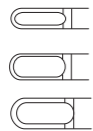

## St Bart's Rongeur

114mm shaft

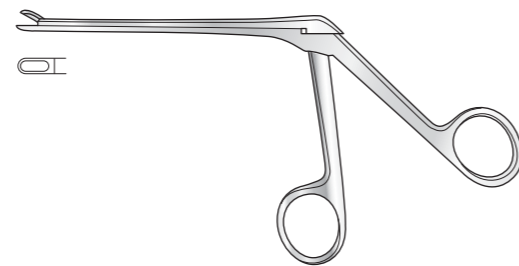

Code	Description
SC-ENT/140a	3mm bite

## Mackay Rongeur

With suction tube

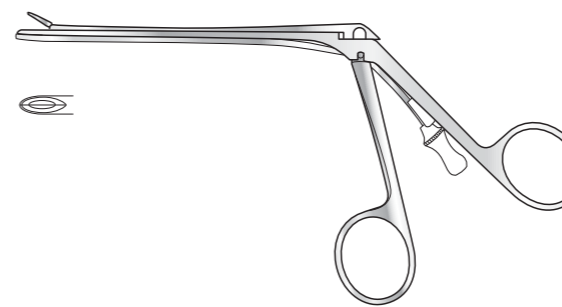

Code	Description
SC-SH/4249a	3.5mm bite, 114mm shaft

## Weil-Blakesley Rongeur

120mm shaft

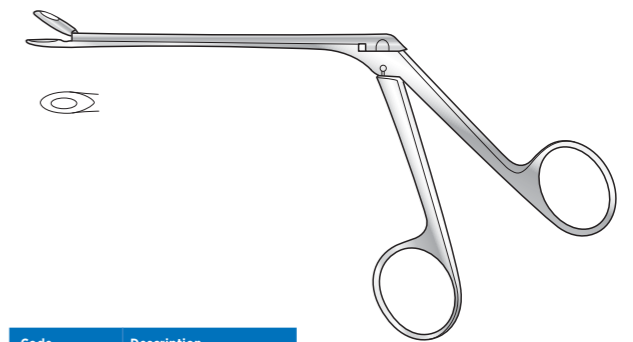

Code	Description
SC-ENT/193b	3.0mm bite
SC-ENT/193	3.6mm bite
SC-ENT/194	4.2mm bite
SC-ENT/194a	4.8mm bite
SC-ENT/194c	5.8mm bite
SC-ENT/194d	6.6mm bite

## Cushing Rongeur

130mm shaft

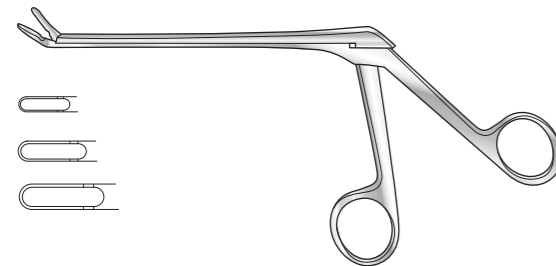

Code	Description
SC-NEU/128c	2mm bite
SC-NEU/128	3mm bite
SC-NEU/128a	4mm bite
SC-NEU/128b	5mm bite

### 150° downward cutting

Code	Description
SC-NEU/130c	2mm bite
SC-NEU/130	3mm bite
SC-NEU/130a	4mm bite
SC-NEU/130b	5mm bite

## St Bart's Rongeur

140°, 3mm, 114mm shaft

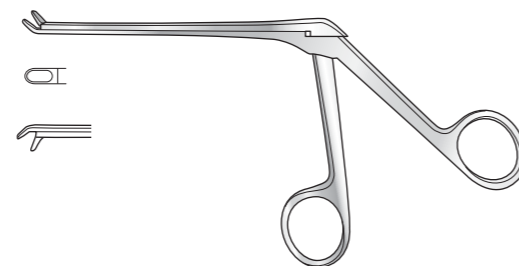

Code	Description
SC-ENT/140b	Upward cutting
SC-ENT/140ac	Downward cutting

## Mackay Rongeur

With suction tube, 140° upward cutting

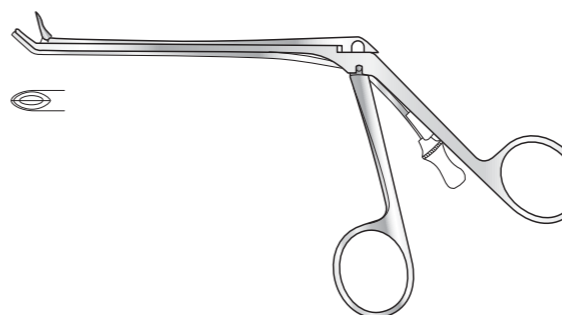

Code	Description
SC-SH/4249b	3.5mm bite, 114mm shaft

**Beckmann Turbinectomy Scissors**

Curved



Code	Description
SC-ENT/097	165mm long

**Fomon Scissors**

Straight, serrated blades, angled handles

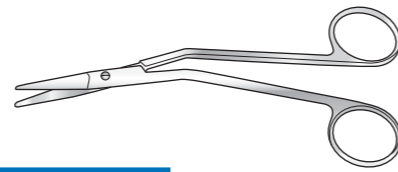

Code	Description
SC-ENT/200	145mm long

**Scott Stevenson Tonsil Scissors**

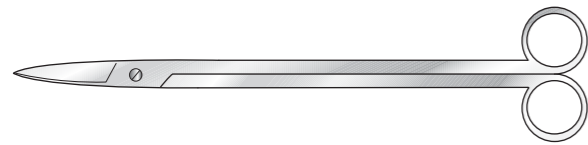

Code	Description
SC-ENT/159	216mm long

**Cottle Scissors**

Straight blades, angled handles, blunt/blunt



Code	Description
SC-ENT/OK201	165mm long

**Wood Tonsil Scissors**

Sharpened outer edges

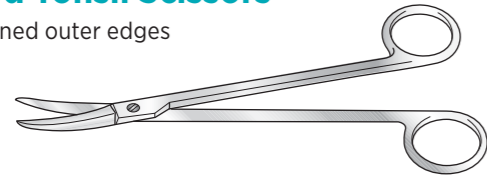

Code	Description
SC-ENT/156	178mm long

**Cottle Bulldog Scissors**

Blunt/blunt, 115mm long

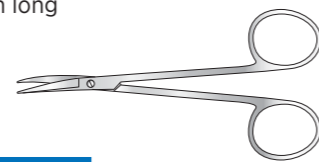

Code	Description
SC-ENT/202	115mm long

**Wheeler Tonsil Scissors**

Triangular form blades, serrated shanks

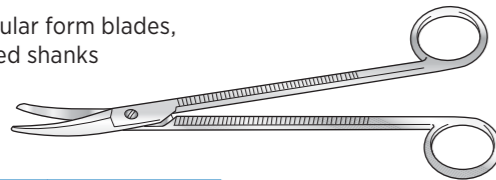

Code	Description
SC-ENT/157	184mm long

**Joseph Scissors**

Sharp/sharp, 150mm long

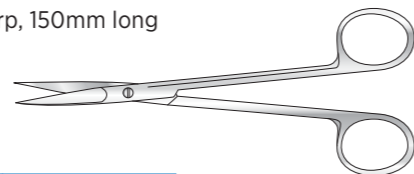

Code	Description
SC-ENT/203	Straight
SC-ENT/204	Curved

**Tilley Tonsil Scissors**

Curved

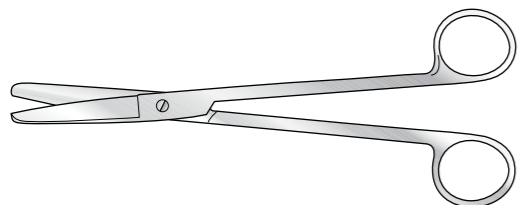

Code	Description
SC-ENT/158	190mm long

**Heymann Turbinectomy Scissors**

Angular

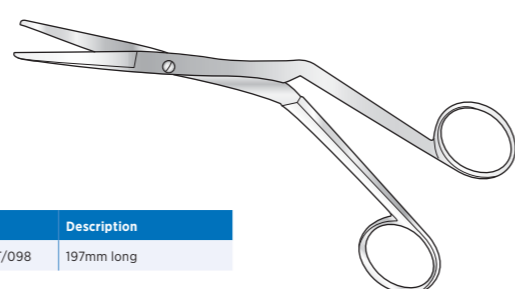

Code	Description
SC-ENT/098	197mm long

**Wilson Tonsil Scissors**

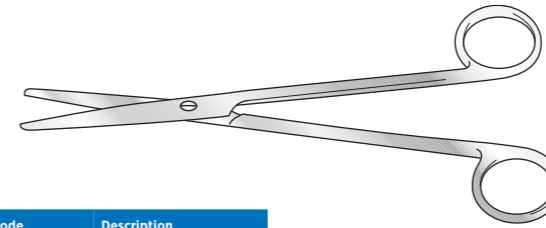

Code	Description
SC-ENT/160	203mm long

**Thyroid Scissors**

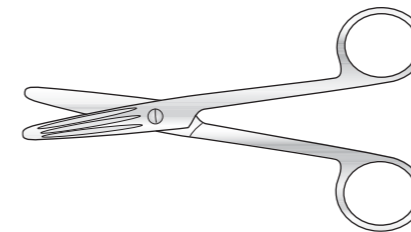

Code	Description
SC-ENT/171	152mm long

**Knapp Scissors**

Slight curve, blunt points, 114mm long

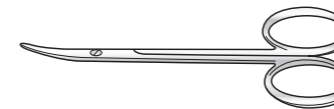

Code	Description
SC-ENT/187a	Satin finish
SC-ENT/187b	Black finish

**Cawthorne Scissors**

Micro, extra fine, 70mm to shoulder

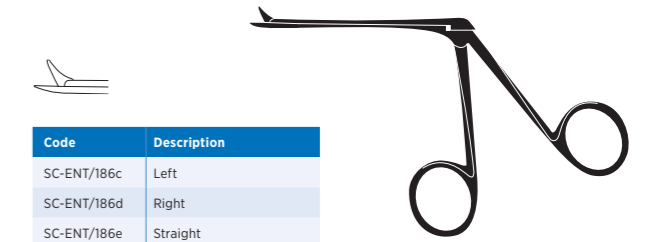

Code	Description
SC-ENT/186c	Left
SC-ENT/186d	Right
SC-ENT/186e	Straight

**Ormorod Aural Scissors**

Micro, extra fine, curved upwards



Code	Description
SC-ENT/185	70mm to shoulder

**Portmann Aural Scissors**

Micro, satin finish, 70mm to shoulder

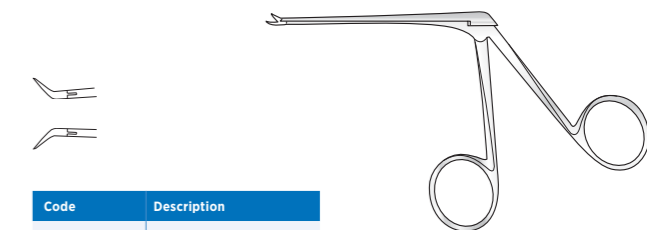

Code	Description
SC-ENT/186a	Curved to right
SC-ENT/186b	Curved to left

**Bissinger BiTech Bipolar Scissors**

- ✓ Enable cutting and dissection with simultaneous bipolar coagulation
- ✓ Used for a large number of applications in open surgery
- ✓ Easy to use and to repair thanks to our patented construction principle
- ✓ Connection cable only needs to be attached to one ring, for easy handling



Available in various sizes with the following blades:

- BiTech Delicate blade
- BiTech Standard blade
- BiTech Supercut
- BiTech Micro

Contact us for full spec list [info@surgicalholdings.co.uk](mailto:info@surgicalholdings.co.uk)

# Gouges, Knives and Elevators

## Ballenger Nasal Cartilage Knife

Revolving blade

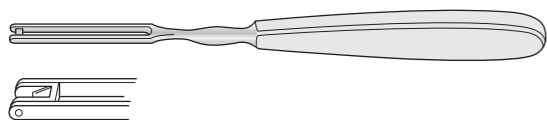

Straight, 203mm long

Code	Description
SC-ENT/096a	6mm wide
SC-ENT/096b	8mm wide

Cranked, 197mm long

Code	Description
SC-ENT/096c	6mm wide

## Sickle Knife



Code	Description
SC-BUPNS002	188mm long
SC-ENT/271	160mm long

## Jenkins Gouge

140mm long



Code	Description	Code	Description
SC-ENT/037	1mm	SC-ENT/037g	8mm
SC-ENT/037a	2mm	SC-ENT/037h	9mm
SC-ENT/037b	3mm	SC-ENT/037i	10mm
SC-ENT/037c	4mm	SC-ENT/037j	11mm
SC-ENT/037d	5mm	SC-ENT/037k	12mm
SC-ENT/037e	6mm	SC-ENT/037l	13mm
SC-ENT/037f	7mm	SC-ENT/037m	14mm

## Killian Nasal Gouge

127mm long



Code	Description
SC-ENT/093	4mm

## Guy's Hospital Nasal Gouge

Shallow groove and flattened back, 127mm long



Code	Description
SC-ENT/094	4mm

## Tilley Nasal Gouge

V shaped, 127mm long



Code	Description
SC-ENT/095	4mm

## Cottle Elevator

Double ended, black chrome finish  
200mm long



Code
SC-ENT/224

## Hill Elevator

Double ended, curved to side, rugine end



Code	Description
SC-ENT/091	5mm wide, 222mm long

## Tumarkin Atticotomy Elevator

Double ended



Code	Description
SC-ENT/036	191mm long

# Curettes and Myringotomes

## Buck Ear Curette

Angled, blunt, 146mm long

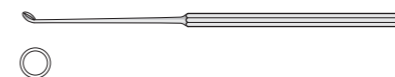

Code	Description
SC-ENT/028	2mm
SC-ENT/028a	2.5mm
SC-ENT/028b	3mm
SC-ENT/028c	3.5mm
SC-ENT/028d	4mm

## Beckmann Adenoid Curette

216mm long

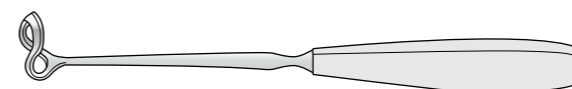

Code	Description
SC-ENT/167a	8mm blade
SC-ENT/167b	10mm blade
SC-ENT/167c	12mm blade
SC-ENT/167d	14mm blade
SC-ENT/167e	16mm blade
SC-ENT/167f	18mm blade

## St Clair Thomson Adenoid Curette

With cage, 235mm long

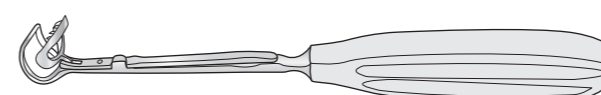

Code	Description
SC-ENT/168a	8mm
SC-ENT/168b	10mm
SC-ENT/168c	12mm
SC-ENT/168d	14mm
SC-ENT/168e	16mm
SC-ENT/168f	18mm

## Nasal Curette

Straight, 185mm long

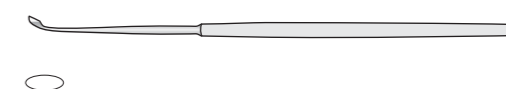

Code	Description
SC-ENT/628702	5 x 2mm

## Agnew (Politzer) Myringotome

190mm long

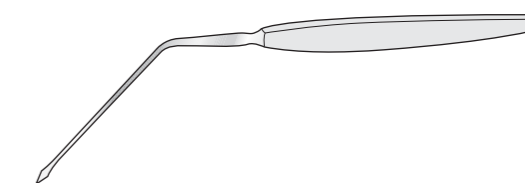

Code	Description
SC-ENT/031	Shaft length 100mm

## Trautmann Myringotome

178mm long



Code	Description
SC-ENT/032	Upward cutting
SC-ENT/033	Downward cutting

## Freer Instruments

Single ended, 190mm long

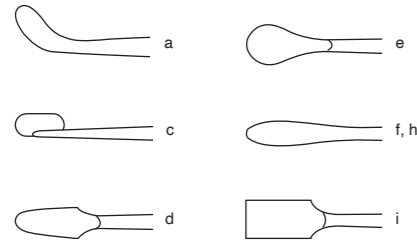

### Knife

Code	Description
SC-ENT/065a	Curved to side
SC-ENT/065c	Rounded edge, 8mm blade
SC-ENT/065d	Flat rounded blade
SC-ENT/065e	Rounded blade, curved on flat

### Elevator

Code	Description
SC-ENT/065f	Dull edged
SC-ENT/065h	Sharp edged

### Chisel

Code
SC-ENT/065i

## Freer Separator and Elevator

Double ended

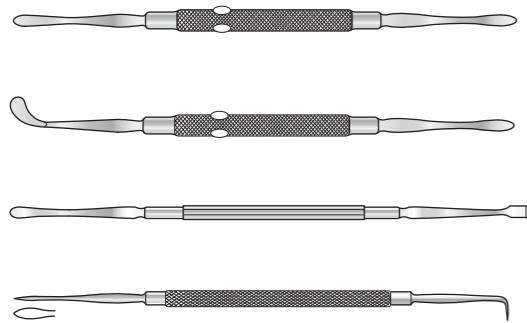

Code	Description
SC-ENT/065b	Blunt/sharp, 180mm long
SC-ENT/065g	Sharp, knife curved to side, 180mm long
SC-ENT/065j	Blunt/sharp, 200mm long
SC-ENT/065j-sal	Blunt/sharp, 188mm long

## St Clair Thompson Dissector

159mm



Code	Description
SC-ENT/089a	Sharp
SC-ENT/089b	Blunt

## Negus Aspiring Dissector

With 6mm olive, 210mm long



Code	Description
SC-ENT/090a	-
SC-ENT/090b	Insulated

## Syme Tonsil Dissector

Double ended, one end blunt, one semi sharp



Code	Description
SC-ENT/149	170mm long

## Gwynne-Evans Tonsil Dissector

Double ended, with serrated end and blunt end 197mm long



Code	Description
SC-ENT/146a	6mm wide
SC-ENT/146b	8mm wide

## Woakes Eustachian Catheters

Silver, Luer, 140mm

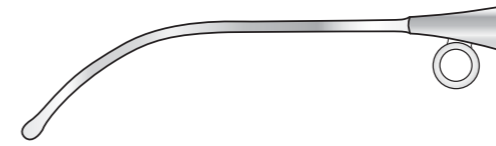

Code	Description	Code	Description
SC-ENT/015	7 F.G.	SC-ENT/015c	10 F.G.
SC-ENT/015a	8 F.G.	SC-ENT/015d	11 F.G.
SC-ENT/015b	9 F.G.		

## Kramer Eustachian Catheters

Silver, Luer, 140mm

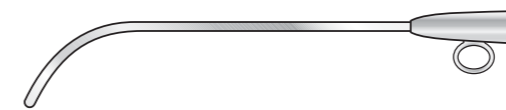

Code	Description	Code	Description
SC-ENT/014	7 F.G.	SC-ENT/014c	10 F.G.
SC-ENT/014a	8 F.G.	SC-ENT/014d	11 F.G.
SC-ENT/014b	9 F.G.		

## Myles Naso-Antral Perforator

171mm long

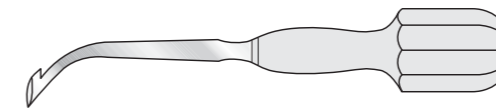

Code	Description
SC-ENT/103a	16 F.G.
SC-ENT/103b	19 F.G.

## Tilley Antrum Burrs

171mm long

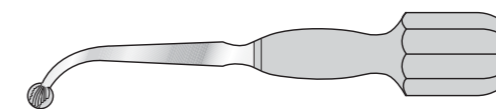

Code	Description
SC-ENT/131a	6mm ø
SC-ENT/131b	7mm ø
SC-ENT/131c	8mm ø

## Laryngeal Mirror

Mirror only, 130mm long

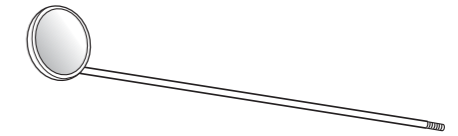

Code	Description	Code	Description
SC-ENT/191-6	6mm ø	SC-ENT/191-20	20mm ø
SC-ENT/191-8	8mm ø	SC-ENT/191-22	22mm ø
SC-ENT/191-10	10mm ø	SC-ENT/191-24	24mm ø
SC-ENT/191-12	12mm ø	SC-ENT/191-26	26mm ø
SC-ENT/191-14	14mm ø	SC-ENT/191-28	28mm ø
SC-ENT/191-16	16mm ø	SC-ENT/191-30	30mm ø
SC-ENT/191-18	18mm ø		

## Laryngeal Mirror

Complete with metal handle, 260mm long

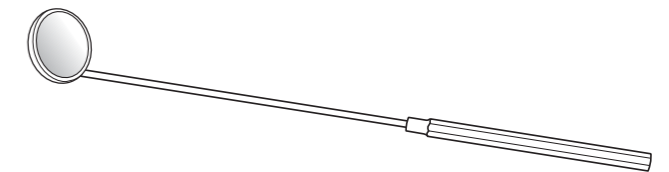

Code	Description	Code	Description
SC-ENT/192-6	6mm ø	SC-ENT/192-20	20mm ø
SC-ENT/192-8	8mm ø	SC-ENT/192-22	22mm ø
SC-ENT/192-10	10mm ø	SC-ENT/192-24	24mm ø
SC-ENT/192-12	12mm ø	SC-ENT/192-26	26mm ø
SC-ENT/192-14	14mm ø	SC-ENT/192-28	28mm ø
SC-ENT/192-16	16mm ø	SC-ENT/192-30	30mm ø
SC-ENT/192-18	18mm ø		

## Mitchell Trimmer



Code	Description
SC-ENT/013	165mm

## Miscellaneous

### Lake Seeker

Double ended, for vestibule



Code	Description
SC-ENT/040	184mm long

### Lempert Rugine

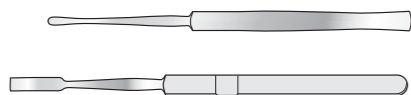

Code	Description
SC-ENT/064a	Narrow, 156mm long
SC-ENT/065a	Broad, 171mm long

### Irwin-Moore Tonsil Needle

203mm long



Code	Description
SC-ENT/164a	Curved to right
SC-ENT/164a	Curved to left

### Negus Pusher

"Knot tier", metal handle



Code	Description
SC-ENT/165	203mm long

### Stanford Cade Insufflator

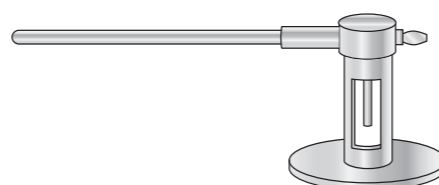

Code	Description
SC-ENT/188	175mm long

### Tubing Mount

For use with catheters, Luer



Code	Description
SC-ENT/016	25mm

## Gynaecology

Clamps	90
Forceps	90
Biopsy Forceps	94
Cervical Forceps	97
Obstetric Forceps	98
Speculum	99
Retractors	101
Curettes	103
Catheters	104
Scissors	106
Miscellaneous	107
Dilators and Sounds	108



### Parametrium Clamp Forceps

Hysterectomy clamp,  
atraumatic jaws,  
two gold bows

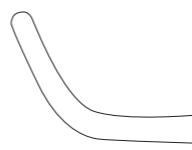
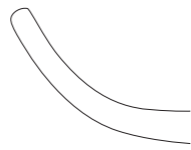
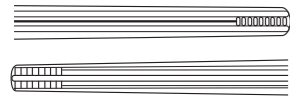
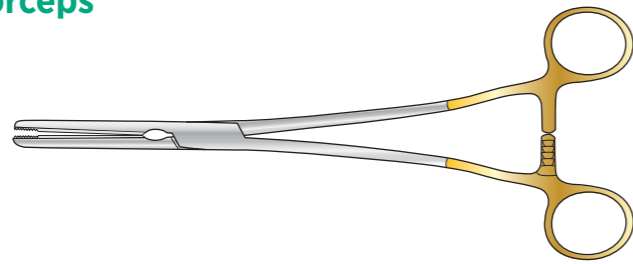

#### Straight

Code	Description
SC-GY/078	203mm long
SC-GY/078a	233mm long
SC-GY/078b	254mm long
SC-GY/078c	304mm long
SC-GY/078d	360mm long

#### Slight curve

Code	Description
SC-GY/078e	203mm long
SC-GY/078f	233mm long
SC-GY/078g	254mm long
SC-GY/078h	304mm long
SC-GY/078i	360mm long

#### Strong curve

Code	Description
SC-GY/078j	203mm long
SC-GY/078k	233mm long
SC-GY/078L	254mm long
SC-GY/078n	360mm long

#### Angled

Code	Description
SC-GY/078o	203mm long
SC-GY/078p	233mm long
SC-GY/078q	254mm long
SC-GY/078r	304mm long
SC-GY/078s	360mm long

### Spencer-Robarts Clamp

For endometrial and pedunculated fibroid polyps, with  
ratchet jaw-locking mechanism, and 50° jaw opening

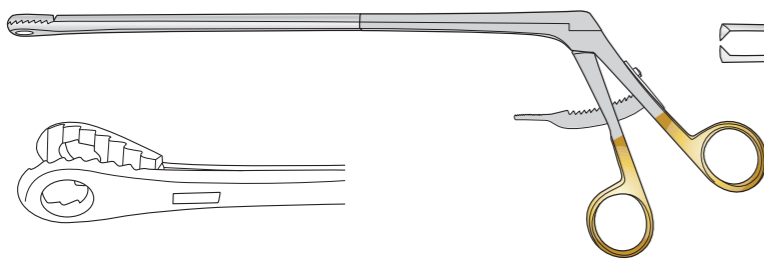

Code	Description
SC-GY/082	Shaft 235mm long

### Museux Vulsellum Forceps

Matt finish

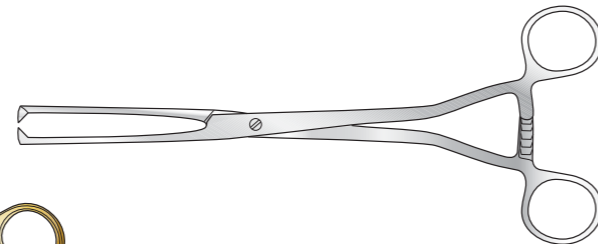

Code	Description
SC-GY/123	240mm long



### Schroeder Uterine Vulsellum Forcep

1-1 teeth

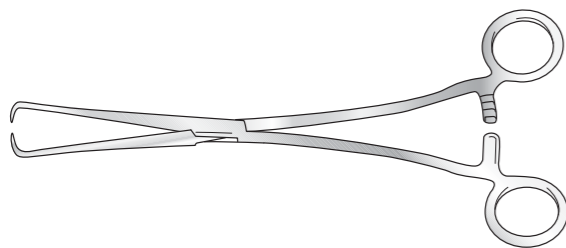

Code	Description
SC-GY/022	229mm long

### Teale Uterine Vulsellum Forcep

3-4 teeth, 230mm long

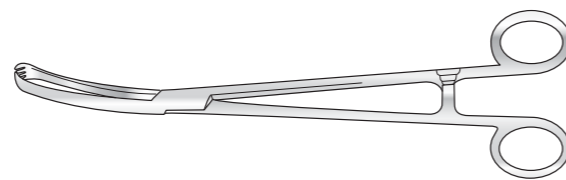

Code	Description
SC-GY/023	Curved
SC-GY/023a	Straight

### Bonney Hysterectomy Forceps

Angled on flat, 1 - 2 teeth

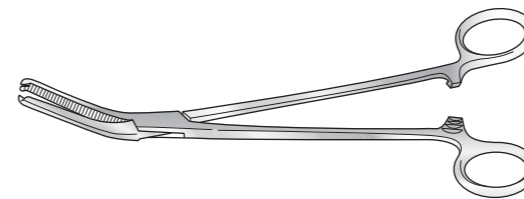

Code	Description
SC-GY/018	197mm long

### Berkeley-Bonney Hysterectomy Forceps

Curved on flat, 1 - 2 teeth

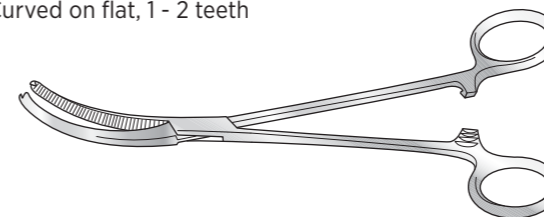

Code	Description
SC-GY/019	203mm long

### Gwilliam Hysterectomy Forceps

Longitudinal serrations  
203mm long

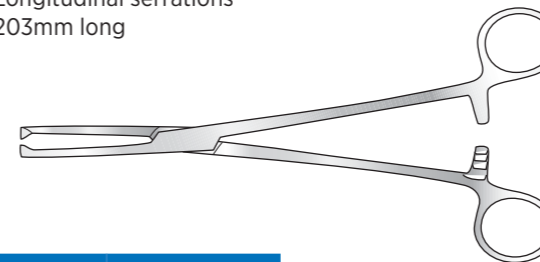

Code	Description
SC-GY/003a	Straight.
SC-GY/003b	Curved on flat, 1-2 teeth

### Heaney Hysterectomy Forceps

Curved on flat, 203mm long

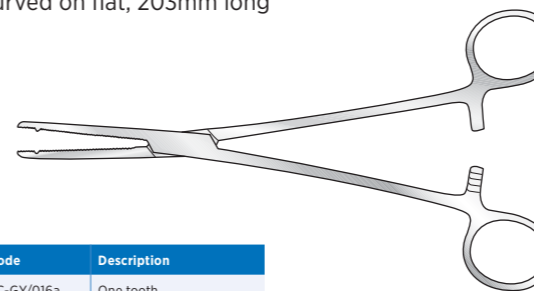

Code	Description
SC-GY/016a	One tooth
SC-GY/016b	Double tooth

### Maingot Hysterectomy Forceps

203mm long

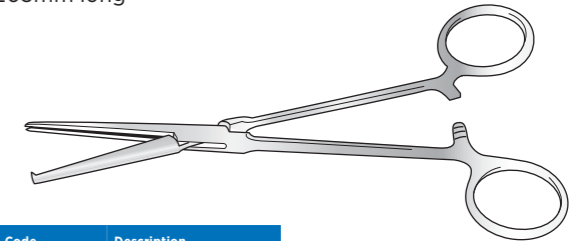

Code	Description
SC-GY/017a	Curved on flat, 1 - 2 teeth
SC-GY/017b	Straight

### Faures Peritoneum Forceps

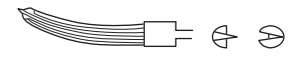
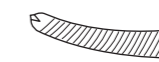
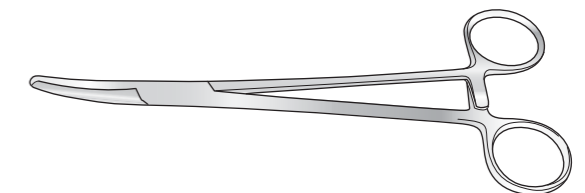

205mm long

Code	Description
SC-GY/146	Slight curve

203mm long,  
longitudinal serrations

Code	Description
SC-GY/5146	Curved, toothed
SC-GY/5146a	Curved

## Proactive Management of your Hysteroscopes and Cystoscopes

Surgical Holdings can set up  
and manage a 'check and repair'  
service for your scopes.

This ensures scopes are regularly  
checked, refurbished, repaired  
and maintained to a high standard.  
We will catalogue your scopes  
and create a maintenance  
schedule for you.

Contact us to arrange your  
scope management service at  
[info@surgicalholdings.co.uk](mailto:info@surgicalholdings.co.uk)

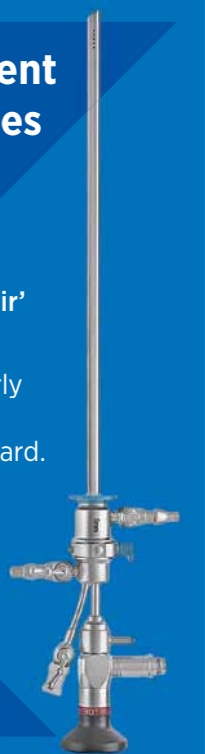

**Bonney Uterine Polypus Forcep**

Box joint

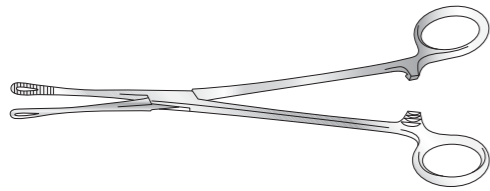

Code	Description
SC-GY/020	240mm long

**Somer Uturus Holding Forcep**

Matt finish

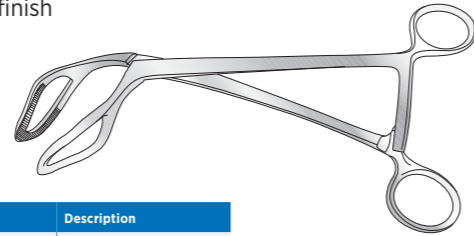

Code	Description
SC-GY/091	230mm long
SC-GY/002	254mm long

**Doyen Ovarian Forceps**

Matt finish

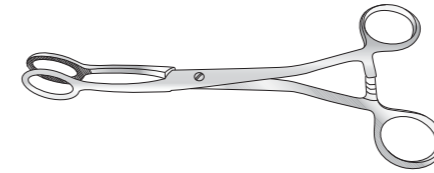

Code	Description
SC-GY/118	210mm long

**Lowa Tenaculum Forceps**

Matt finish, 5-6 teeth

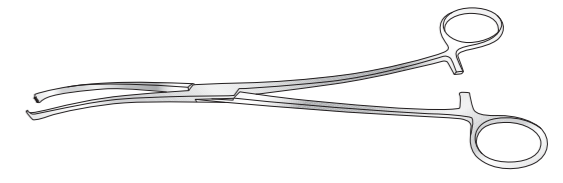

Code	Description
SC-GY/094	260mm long

**Noto Uterine Polypus Forceps**

Matt finish

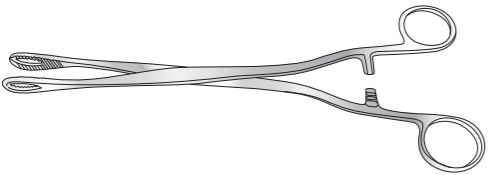

Code	Description
SC-GY/124	240mm long

**McClintock Ovum Forcep**

Curved, screw joint



Code	Description
SC-GY/036	241mm long

**Wertheim Parametrium Forcep**

Curved on flat, screw joint

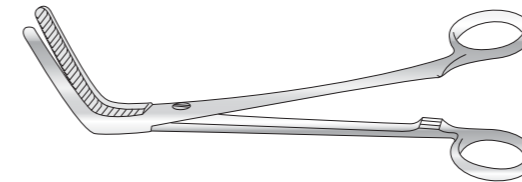

Code	Description
SC-GY/005	254mm long

**Skene Tenaculum Forceps**

Bright finish

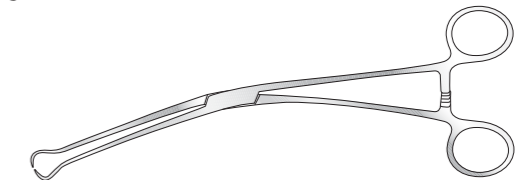

Code	Description
SC-GY/120	240mm long

**Vant Uterine Polypus Forcep**

Serrated

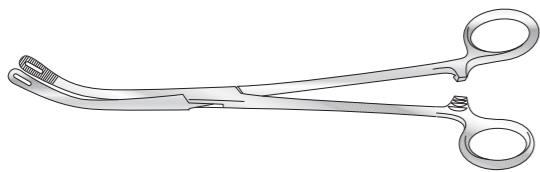

Code	Description
SC-GY/021	240mm long

**Greenhalgh Ovum Forcep**

Screw joint

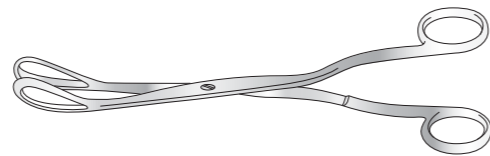

Code	Description
SC-GY/037	240mm long

**Green-Armytage Haemostasis Forcep**

Screw joint, 15mm jaw, 210mm long

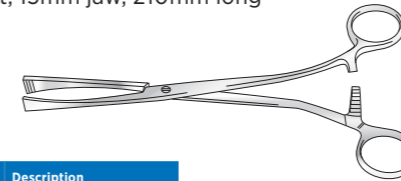

Code	Description
SC-GY/029a	Straight
SC-GY/029b	Angled

**Pratt Tenaculum Forceps**

Matt finish

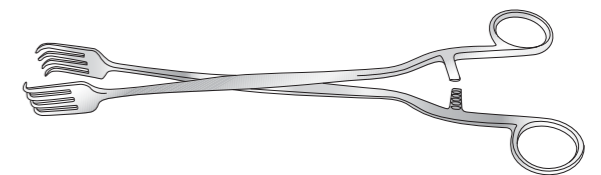

Code	Description
SC-GY/095	280mm long

**Dartigues Uterine Forceps**

Matt finish

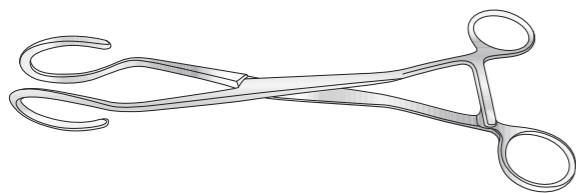

Code	Description
SC-GY/090	270mm long

**Keily Ovum Forceps**

Matt finish

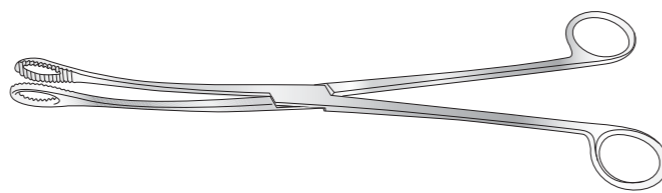

Code	Description
SC-GY/111	320mm long

**Kogan Endocervical Forceps**

Matt finish, 275mm long

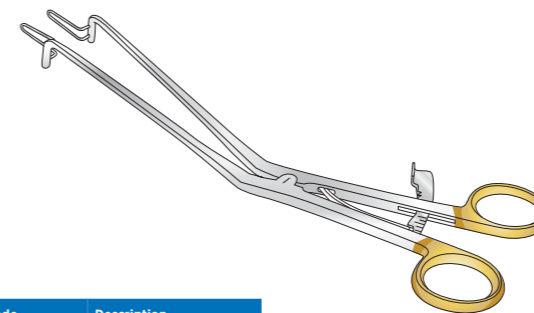

Code	Description
SC-GY/131	3mm jaw
SC-GY/131a	5mm jaw
SC-GY/131b	7mm jaw

**Coil Removing Forcep**

With serrated rounded jaws  
4mm wide

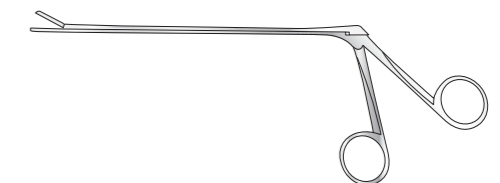

Code	Description
SC-GY/075	160mm to shoulder

# Forceps and Biopsy Forceps

FOR INFORMATION ON BLACK AND GOLD BOWS SEE PAGE 23

# Biopsy Forceps

## Willet Martel Forceps

Matt finish

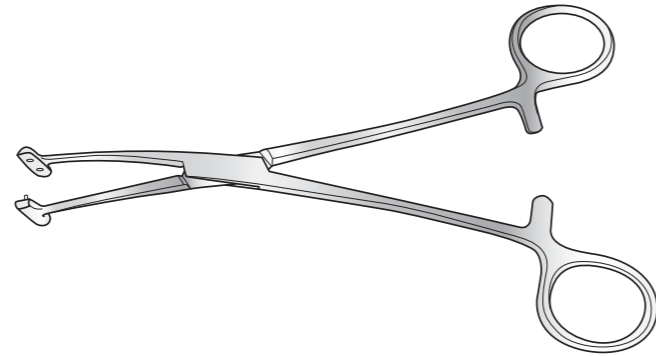

Code	Description
SC-GY/121	190mm long



## Littlewood Tissue Forceps

2-3 teeth, matt finish

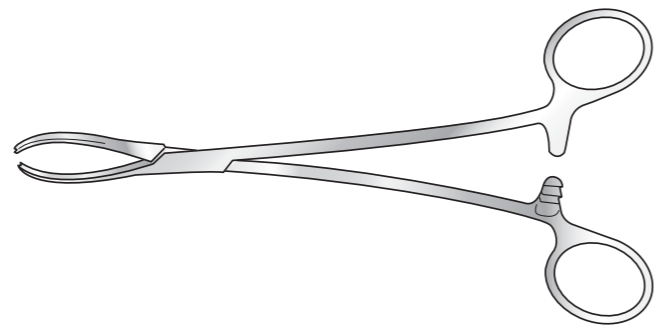

Code	Description
SC-GY/275	190mm long

## Eppendorf Biopsy Punch Forcep

200mm to shoulder

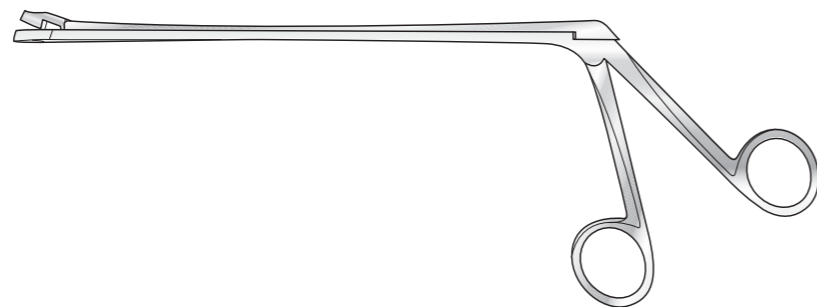

Bite shown actual size

Code	Description
SC-GY/14-314-200	3mm x 8mm bite

## Kevorkian Biopsy Punch Forcep

255mm to shoulder

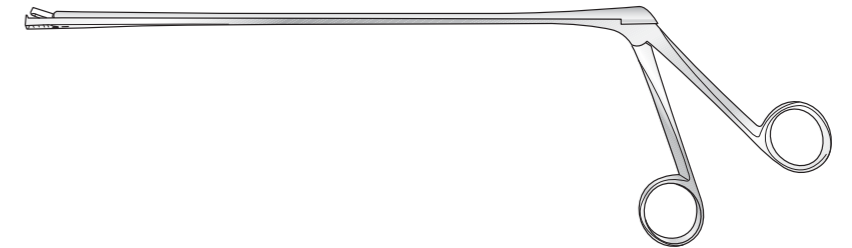

Bite shown actual size

Code	Description
SC-GY/14-329-250	3mm x 8mm bite

## Tischler Morgan Biopsy Forcep

210mm to shoulder

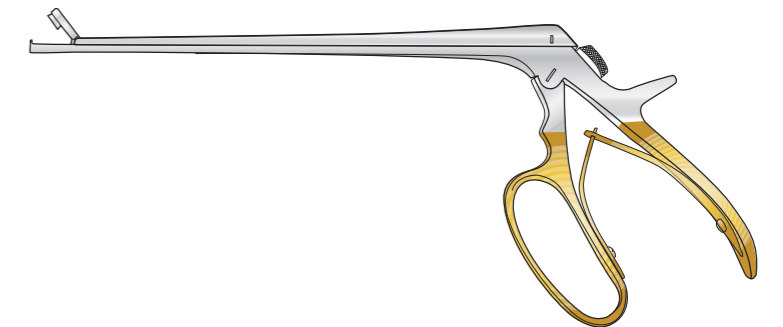

Bite shown actual size

Code	Description
SC-GY/14-328-220	3mm x 7mm bite

## Tischler Morgan Biopsy Punch Forcep

295mm to shoulder

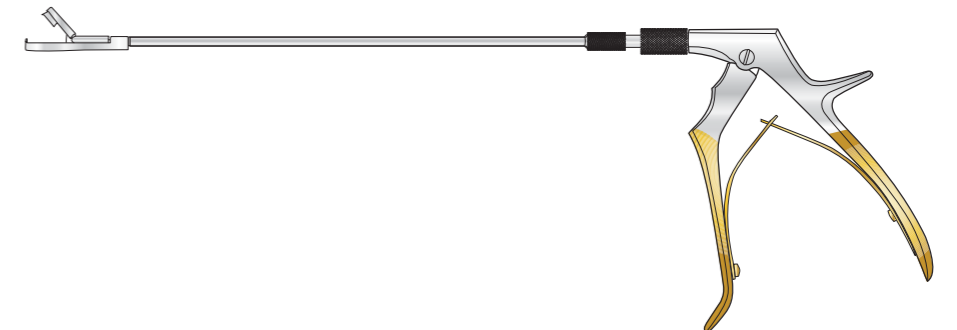

Bite shown actual size

Code	Description
SC-GY/088	2mm x 7mm bite





## Biopsy Forceps

FOR INFORMATION ON  
BLACK AND GOLD BOWS  
SEE PAGE 23

### Baby Tischler Biopsy Forcep

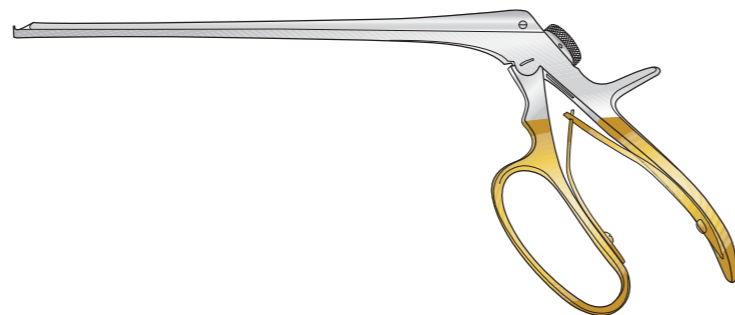
210mm to shoulder





 Bite shown actual size

Code	Description
SC-GY/14-325-250	2mm x 5mm bite

### Baby Tischler Biopsy Punch Forcep

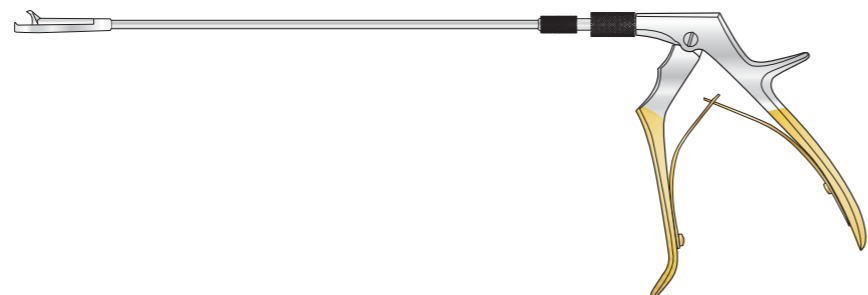
295mm to shoulder





 Bite shown actual size

Code	Description
SC-GY/087	2mm x 5mm bite

### Van Doren Biopsy Forceps

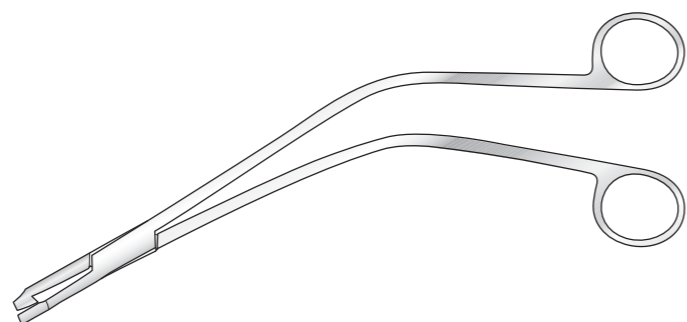
Bright finish, 260mm overall length



 Bite shown actual size

Code	Description
SC-GY/112	5mm x 9mm bite

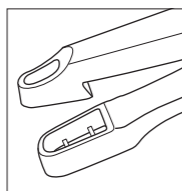

## Cervical Forceps

### Van Doren Cervical Biopsy Punch Forcep

With curved basket jaw, angled shanks

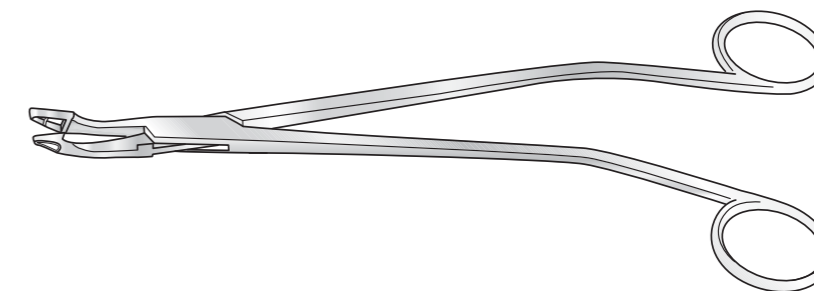

Code	Description
SC-GY/025	240mm long

### Wittner Cervical Biopsy Punch Forcep

240mm long shaft

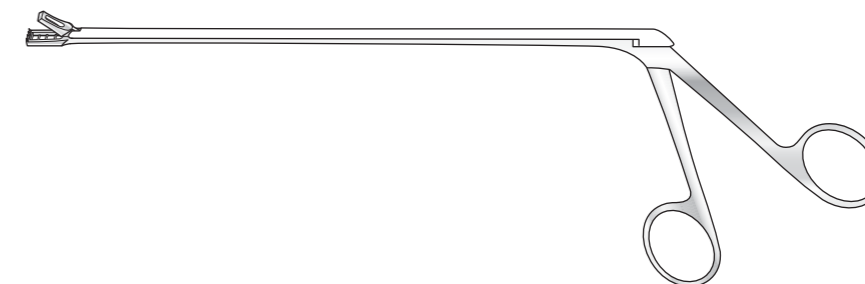

Code	Description
SC-GY/024a	Jaws curved to side
SC-GY/024b	Jaws straight to side

## Bovie electrosurgical generators and electrosurgical consumables are now available through Surgical Holdings

 symmetry surgical  
authorised distributor

**Bovie**

We recommend the Bovie Bantam and A1250S for (Loop Electrosurgical Excision Procedure) LEEP procedures

- Symmetry Surgical has proudly welcomed the Bovie<sup>®</sup> electrosurgical product line to our portfolio
- Bovie is the only company to manufacture Electrosurgical Generators from 10 Watt up to 300 Watt



**+ Industry-beating  
4 Year  
Warranty**

For information on the full Bovie range email [info@surgicalholdings.co.uk](mailto:info@surgicalholdings.co.uk)

Generators / Electrodes / Cauteries / Forceps / Pencils / Accessories

# Obstetric Forceps

## Barnes Obstetric Forcep

With Simpson handles and Neville axis traction rod

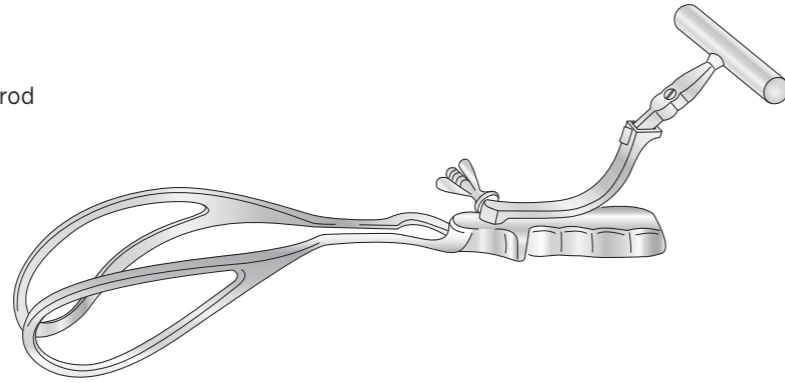

Code	Description
SC-GY/027	381mm long

## Haig Ferguson Obstetric Forcep

Tape slots in blades and axis traction rod

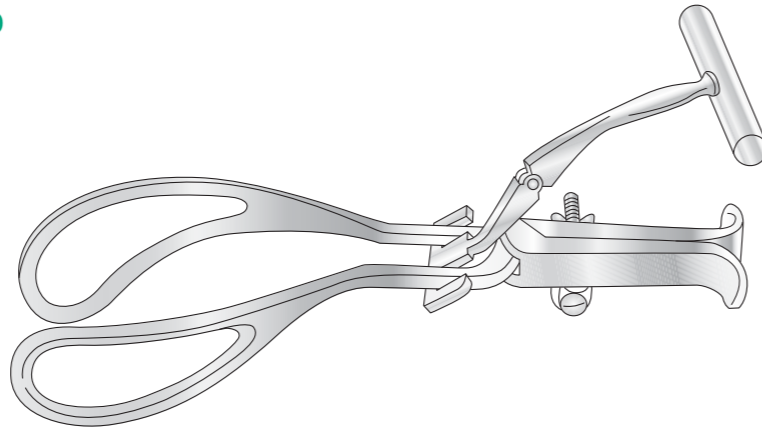

Code	Description
SC-GY/028	356mm long

## Kieland Obstetric Forcep

Matt finish

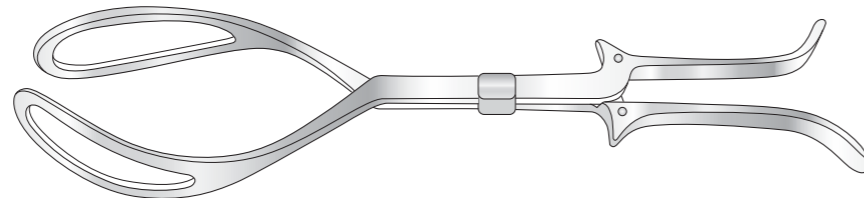

Code	Description
SC-GY/089	410mm long

## Simpson Braun Obstetric Forcep

Matt finish

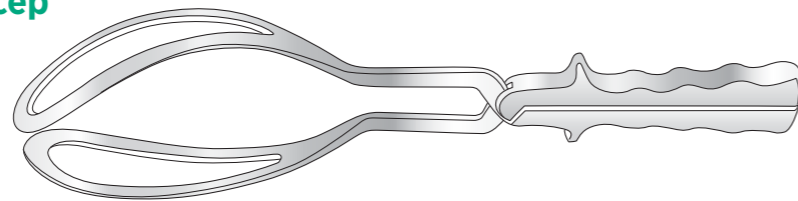

Code	Description
SC-GY/086	380mm long

## Wrigley Obstetric Forcep

Short model for caesarian section

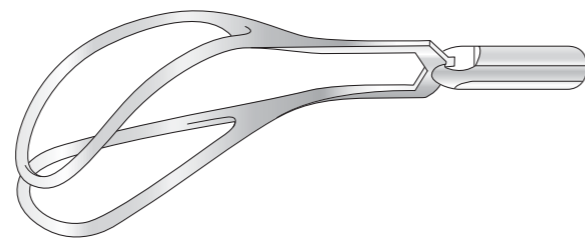

Code	Description
SC-GY/026	279mm long

# Speculum

## Auvard Vaginal Speculum

Weighted

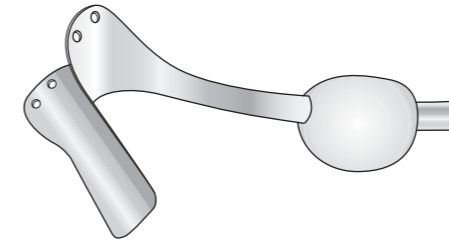

Code	Description
SC-GY/007a	Small blade 38 x 90mm
SC-GY/007b	Large blade 51 x 90mm

## Collin Vaginal Speculum

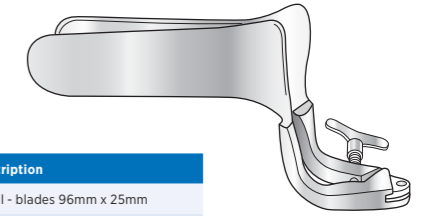

Code	Description
SC-GY/014a	Small - blades 96mm x 25mm
SC-GY/014b	Medium - blades 108mm x 30mm
SC-GY/014c	Large - blades 108mm x 35mm

## Nott Speculum

Stainless steel

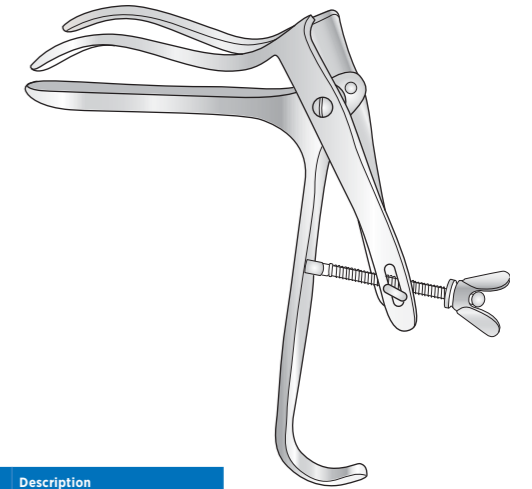

Code	Description
SC-GY/04102	Blade 110mm long, 30mm wide

## Graves Vaginal Speculum

Bright finish



Code	Description
SC-GY/103	115 x 35mm

## Cusco Vaginal Speculum

Stainless steel

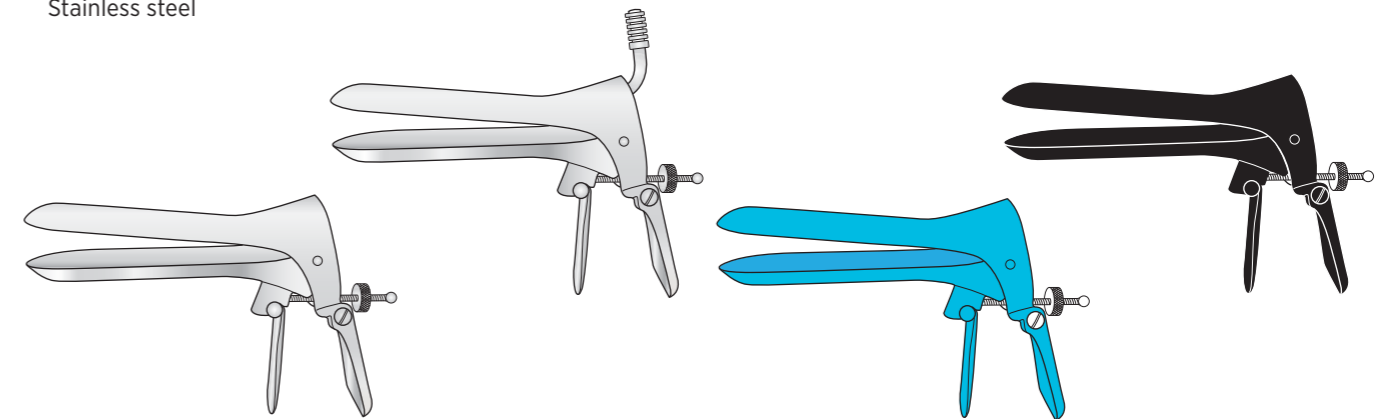

Insulated		With Suction Tube		Black Finish	
Code	Description	Code	Description	Code	Description
SC-GY/015d	Extra small - 98mm x 16mm	SC-GY/134	Small - 105mm x 25mm	SC-GY/015k	Small - 105mm x 25mm
SC-GY/015c	Small - 105mm x 25mm	SC-GY/135	Medium - 107mm x 29mm	SC-GY/015j	Medium - 107mm x 29mm
SC-GY/015f	Medium - 107mm x 29mm	SC-GY/136	Large - 115mm x 35mm	SC-GY/015i	Large - 115mm x 35mm
SC-GY/015e	Large - 115mm x 35mm	SC-GY/137	Extra large - 135mm x 38mm	SC-GY/015h	Extra large - 135mm x 38mm
				SC-GY/138	Small - 105mm x 25mm
				SC-GY/139	Medium - 107mm x 29mm
				SC-GY/140	Large - 115mm x 35mm
				SC-GY/141	Extra large - 135mm x 38mm

### Pederson Vaginal Speculum

Stainless steel

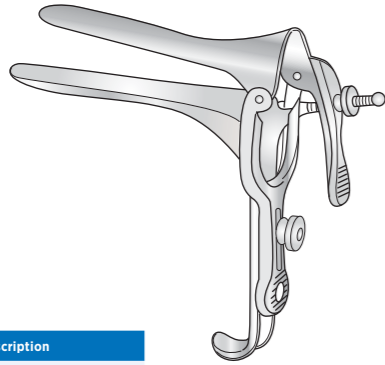

Code	Description
SC-GY/078	120mm x 25mm wide
SC-GY/078a	90mm x 20mm wide

### Sims Duckbill Speculum

Double ended

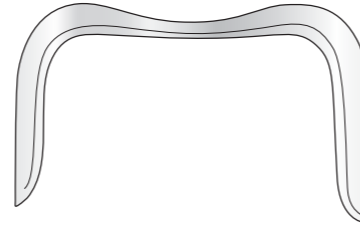

Code	Description
SC-GY/012a	Small - 27mm x 29mm x 130mm long
SC-GY/012b	Medium - 30mm x 33mm x 158mm long
SC-GY/012c	Large - 33mm x 38mm x 184mm long

### Sims Duckbill Speculum

Double ended, insulated

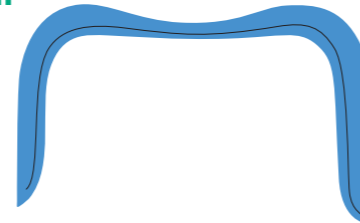

Code	Description
SC-DIA/031	Small - 27mm x 29mm x 130mm long
SC-DIA/032	Medium - 30mm x 33mm x 158mm long
SC-DIA/033	Large - 33mm x 38mm x 184mm long

### Winterton Vaginal Speculum

Stainless steel

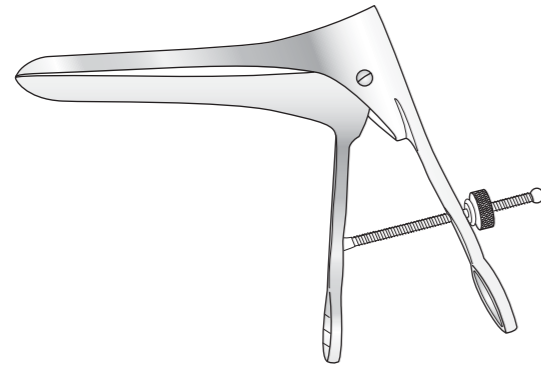

Code	Description
SC-GY/074	Blade 115mm long, 25mm wide

### Modified Speculum

Stainless steel, for elderly patients

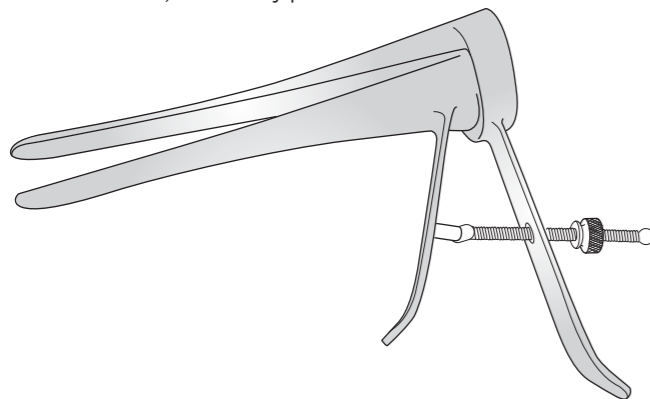

Code	Description
SC-GY/074a	Blade 180mm long, 18mm wide

### Breisky Vaginal Retractor

Bright finish, matt handle  
320mm long

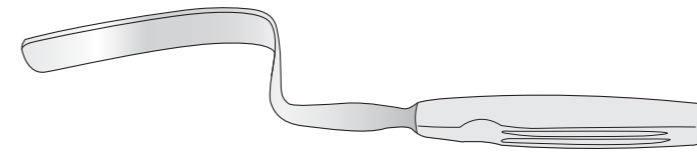

Code	Description
SC-GY/110	25mm blade

### Doyen Retractor

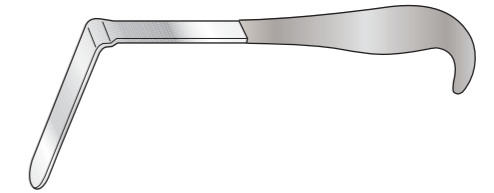

Code	Description
SC-GY/009b	Blade 100mm x 30mm

### Doyen Rectangular Retractor

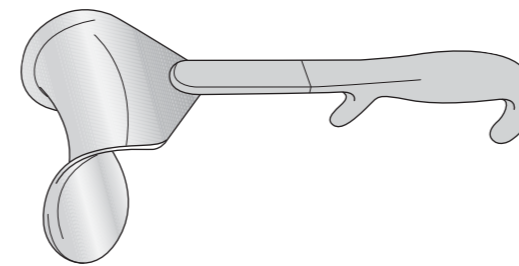

Code	Description
SC-GY/008a	Small - 48 x 60mm
SC-GY/008b	Medium - 48 x 89mm
SC-GY/008c	Large - 48 x 124mm

### St Mark's Hospital Pattern Retractor

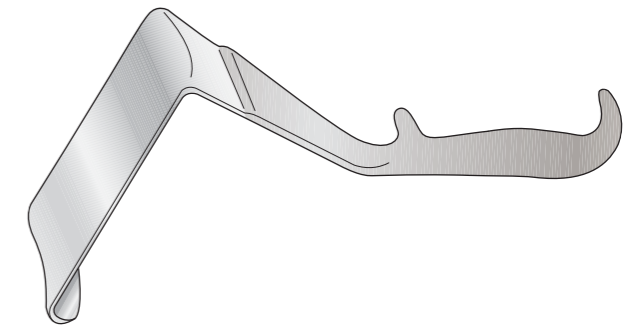

With lip		Without lip	
Code	Description	Code	Description
SC-GY/065	Blade 125mm x 60mm	SC-GY/067	Blade 125mm x 60mm
SC-GY/066	Blade 175mm x 60mm	SC-GY/068	Blade 175mm x 60mm

### Doyen Retractor

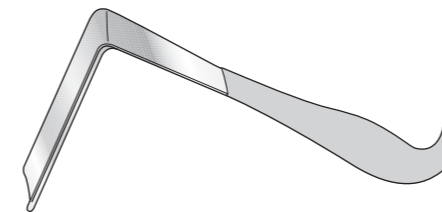

Code	Description
SC-GY/009a	Blade 95mm x 27mm

### Wertheim Retractor

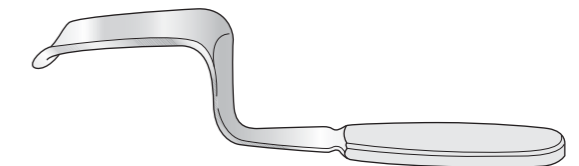

Code	Description
SC-GY/010	Blade 95mm x 38mm



### Bovie Smoke Shark II

#### Optimal Control, Better Protection

Smoke Shark is essential in procedures where HPV may be present and could be inhaled by either patient or clinician

- Protects OR staff from the risk of exposure to Biological, Physical and Chemical Hazards
- Lightweight, compact and ultra-quiet
- Easy to set up and operate
- Extensive life filter (SF35) offers up to 35 hours performance with 3 flow settings



[info@surgicalholdings.co.uk](mailto:info@surgicalholdings.co.uk)

Landon Vaginal Retractor

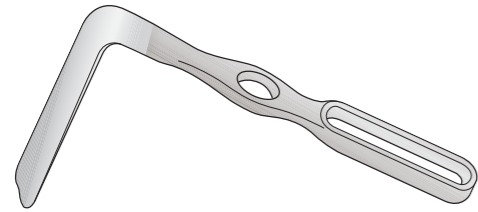

Code	Description
SC-GY/011	Blade 89mm x 25mm

Lateral Vaginal Retractor

Blades bright finish, matt handle



Code	Description
SC-GY/128	60 x 20mm blade
SC-GY/128a	75 x 22mm blade
SC-GY/128b	110 x 23mm blade

AVAILABLE INSULATED  
ADD SUFFIX 'INS'

Whitlow Retractor

Vaginal retractor, for use with supplied blades. Points of retraction move around almost 360°. Supplied complete with sterilising basket and three sets of blades.

Frame

225mm at widest point

Blades

1 x anterior and 1 x posterior 90°, 25mm x 100mm  
2 x lateral 90°, 25mm x 70mm  
2 x lateral 75°, 25mm x 70mm

Code
SC-GY/084

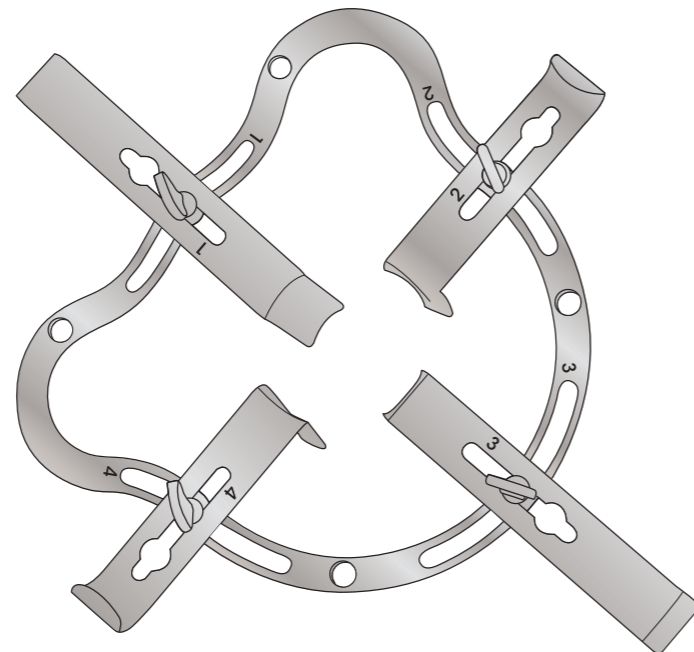
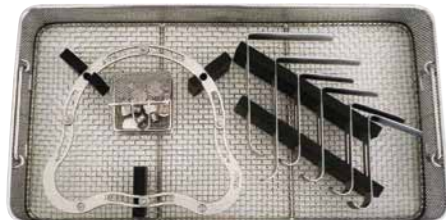

The Genuine Bookwalter®  
Magrina Retractor System

Optimized for vaginal hysterectomy, Symmetry Surgical's Bookwalter® Magrina Retractor System uses the latest Bookwalter® innovations to enhance function and stability during retraction.

Contact us for full spec and to order  
[info@surgicalholdings.co.uk](mailto:info@surgicalholdings.co.uk)



Kevorkian Biopsy Curette

313mm long

Code	Description
SC-GY/105	With basket
SC-GY/127	Without basket



Novak Curette

Code	Description
SC-GY/119	230mm long



Recamier Uterine Curette

Matt finish, 310mm long

Code	Description
SC-GY/108	Blunt
SC-GY/109	Sharp



Rheinstadter Flushing Curette

290mm long

Sharp

Code	Description
SC-GY/076a	Sharp, 8mm
SC-GY/076b	Sharp, 14mm

Blunt

Code	Description
SC-GY/076c	Blunt, 8mm
SC-GY/076d	Blunt, 14mm



Sims Uterine Curette

Single ended, 255mm long, matt finish

Sharp

Code	Description
SC-GY/075a	Small 6mm
SC-GY/075b	Medium 10mm
SC-GY/075c	Large 13mm

Blunt

Code	Description
SC-GY/075d	Small 6mm
SC-GY/075e	Medium 10mm
SC-GY/075f	Large 13mm



Sims Uterine Curette

Double ended, 250mm long

Sharp

Code	Description
SC-GY/044	Small 7 x 5mm
SC-GY/045	Medium 10 x 7mm
SC-GY/046	Large 13 x 10mm

Blunt

Code	Description
SC-GY/047	Small 7 x 5mm
SC-GY/048	Medium 10 x 7mm
SC-GY/049	Large 13 x 10mm



**Rotunda Hospital Pattern Catheter**

With solid end, chromium plated, 203mm long

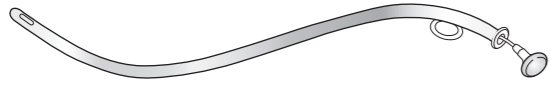

Code	Description
SC-GY/035a	8 E.G.
SC-GY/035b	10 E.G.

**Catheter**

Oval, solid end, chromium plated



Code	Description
SC-GY/034	165mm long

**Catheter Introducer**

With eye in handle, curved



Code	Description
SC-GY/071d	2mm x 420mm long

**Catheter Introducer**

457mm long



Code	Description
SC-GY/071	Straight, 2mm ø
SC-GY/071a	Curved, 2mm ø

**Catheter Introducer**

Fixed handle



Code	Description
SC-GY/071e	445mm long

**Catheter Introducer**



Code	Description
SC-GY/071b	Fine, 395mm long

**Catheter Introducer**



Code	Description
SC-GY/071f	400mm long

**Catheter Introducer**

Bulbous end, with eye in handle



Code	Description
SC-GY/071c	Curved, 2mm x 410mm long

**Catheter Introducer**

410mm long



Code	Description
SC-GY/071g	410mm long

# Scissors

FOR INFORMATION ON BLACK AND GOLD BOWS SEE PAGE 23

## Barnes Episiotomy Scissors

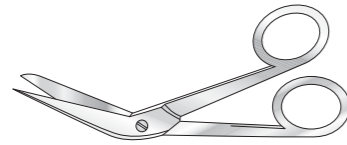

Code	Description
SC-GY/032	127mm long

## Braun Stadler Episiotomy Scissors

Matt finish

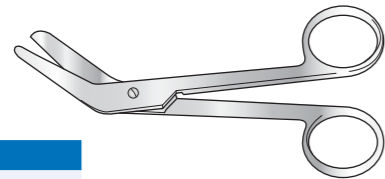

Code	Description
SC-GY/063	140mm long
SC-GY/064	222mm long

## Vant Episiotomy Scissors



Code	Description
SC-GY/033	76mm blades, 241mm long

## Busch Umbilical Scissors

Matt finish

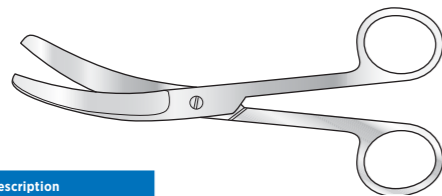

Code	Description
SC-GY/116	160mm long

## Umbilical Scissors

American pattern



Code	Description
SC-GY/031	102mm long

## Simms Uterine Scissors

Curved, tungsten carbide, with two gold bows

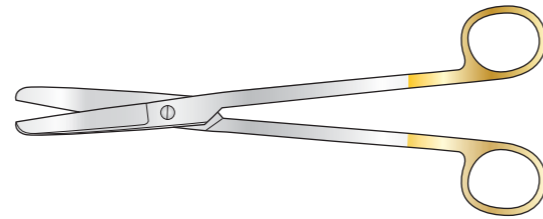

Code	Description
SC-GY/115	200mm long

## Dubois Uterine Scissors

Matt finish

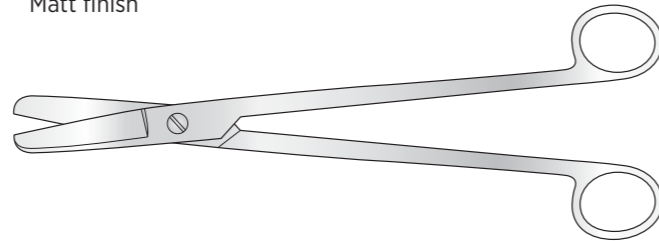

Code	Description
SC-GY/114	270mm long

## Uterine Scissors

Curved on flat

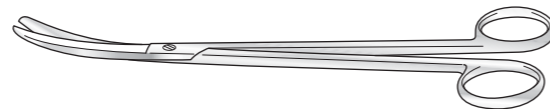

Code	Description
SC-GY/030a	203mm long

## Uterine Scissors

Angled on flat

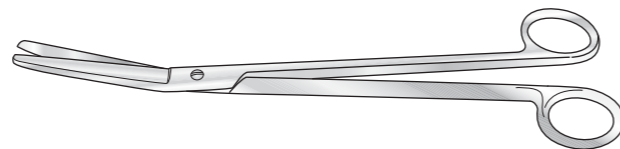

Code	Description
SC-GY/030b	230mm long

FOR INFORMATION ON BLACK AND GOLD BOWS SEE PAGE 23

# Scissors and Miscellaneous

## Parametrium Scissors

225mm long

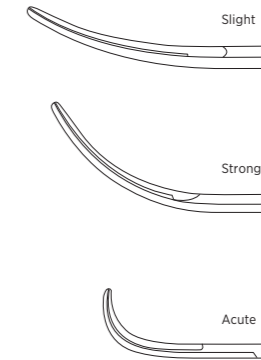
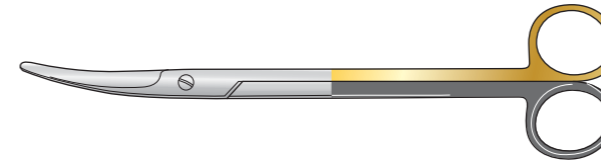

Tungsten carbide, standard, with two gold bows

Code	Description
SC-GY/080	Slight curve
SC-GY/080a	Strong curve
SC-GY/080b	Acute curve

Tungsten carbide, supercut, with one gold and one black bow

Code	Description
SC-GY/081	Slight curve
SC-GY/081a	Strong curve
SC-GY/081b	Acute curve

## Miscellaneous

### Bonney Myomectomy Clamp

With 51mm jaws, screw joint

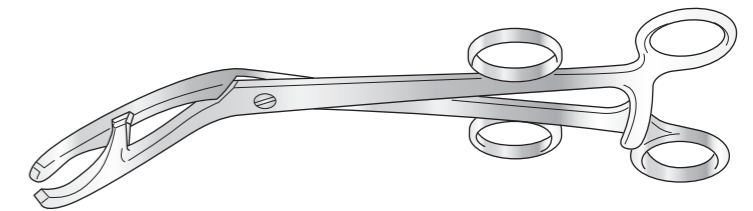

Code	Description
SC-GY/004	267mm long

### Sims Vaginal Depressor

Double ended

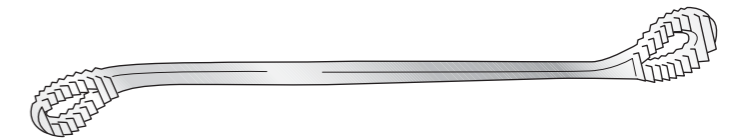

Code	Description
SC-GY/039	260mm long

### Spackman Uterine Cannula

Chrome plated, 360mm long



Code	Description
SC-GY/040	12 F.G. with rubber cone
SC-GY/040a	14 F.G. with metal cone
SC-GY/040b	14 F.G. with rubber cone
SC-GY/040c	18 F.G. with metal cone
SC-GY/040d	18 F.G. with rubber cone

### Doyen Myoma Screw Large

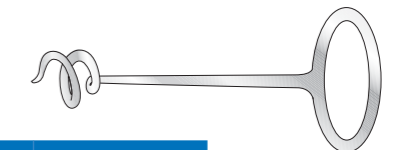

Code	Description
SC-GY/006a	178mm long

### Doyen Myoma Screw Small

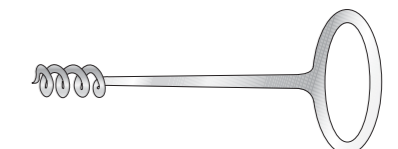

Code	Description
SC-GY/006b	178mm long

## Dilators and Sounds

### Galabin Uterine Sound

Calibrated 4-24, bright finish



Code	Description
SC-GY/106	305mm long

### Sims Uterine Sound

Calibrated 4-24, bright finish

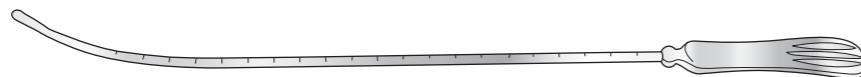

Code	Description
SC-GY/107	320mm long

### Umbilical Dilator



Code	Description
SC-GY/038	95mm long

### Hawkin Ambler Cervix Dilators

Conical, 171mm long



Code	Description
SC-GY/050	Set of 12
SC-GY/051	Size 3 - 6mm
SC-GY/052	Size 4 - 7mm
SC-GY/053	Size 5 - 8mm
SC-GY/054	Size 6 - 9mm
SC-GY/055	Size 7 - 10mm
SC-GY/056	Size 8 - 11mm

Code	Description
SC-GY/057	Size 9 - 12mm
SC-GY/058	Size 10 - 13mm
SC-GY/059	Size 11 - 14mm
SC-GY/060	Size 12 - 15mm
SC-GY/061	Size 13 - 16mm
SC-GY/062	Size 14 - 17mm

### Hegar Cervix Dilator

Single ended, 185mm long



Code	Description
SC-GY/70SE1	1mm ø
SC-GY/70SE2	2mm ø
SC-GY/70SE3	3mm ø
SC-GY/70SE4	4mm ø
SC-GY/70SE5	5mm ø
SC-GY/70SE6	6mm ø
SC-GY/70SE7	7mm ø
SC-GY/70SE8	8mm ø
SC-GY/70SE9	9mm ø

Code	Description
SC-GY/70SE10	10mm ø
SC-GY/70SE11	11mm ø
SC-GY/70SE12	12mm ø
SC-GY/70SE13	13mm ø
SC-GY/70SE14	14mm ø
SC-GY/70SE15	15mm ø
SC-GY/70SE16	16mm ø
SC-GY/70SE17	17mm ø

### Hegar Cervix Dilator

Double ended, 200mm long

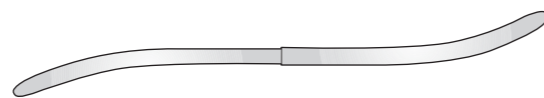

Code	Description
SC-GY/070j	Set of 8: from sizes 1 and 2mm to 15 and 16mm
SC-GY/070h	1 and 2mm ø
SC-GY/070	3 and 4mm ø
SC-GY/070a	5 and 6mm ø
SC-GY/070b	7 and 8mm ø

Code	Description
SC-GY/070c	9 and 10mm ø
SC-GY/070d	11 and 12mm ø
SC-GY/070e	13 and 14mm ø
SC-GY/070f	15 and 16mm ø
SC-GY/070g	17 and 18mm ø

## Intestinal

Forceps	110
Clamps	112
Miscellaneous	113

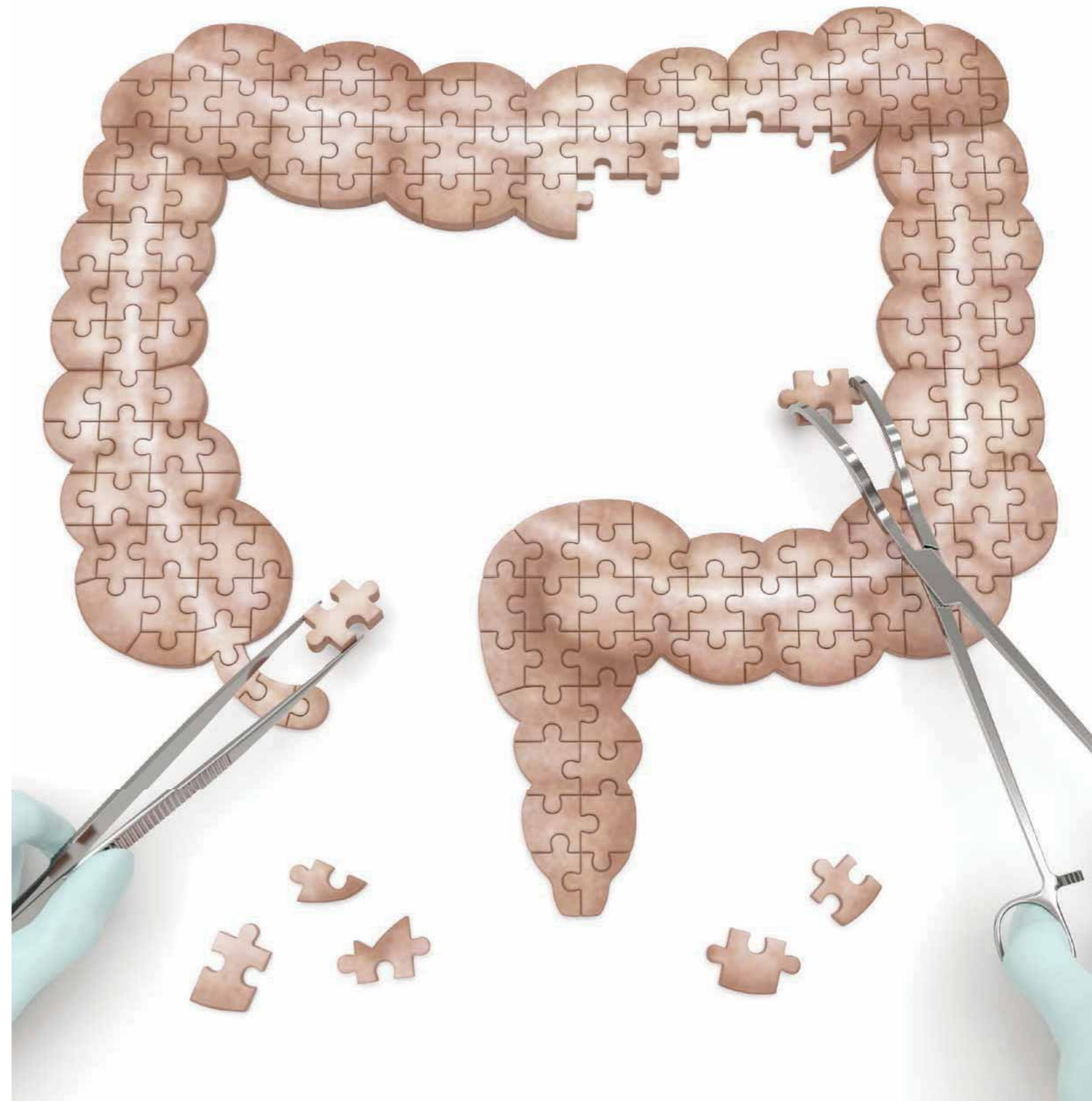

**Desjardin Gall Stone Forceps**

Screw joint

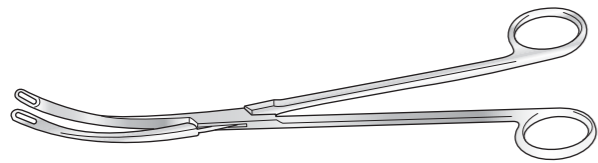

Code	Description
SC-IN/001a	Small, 220mm long
SC-IN/001b	Large, 238mm long

**Lane Stomach Holding Forceps**

Straight, serrated jaws, screw joint

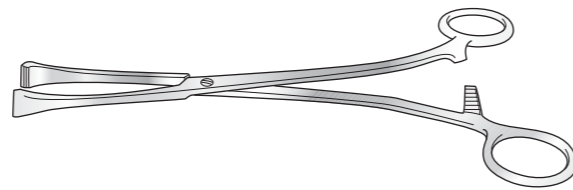

Code	Description
SC-IN/008	203mm long

**Moynihan Cholecystectomy Forceps**

Curved on flat, screw joint

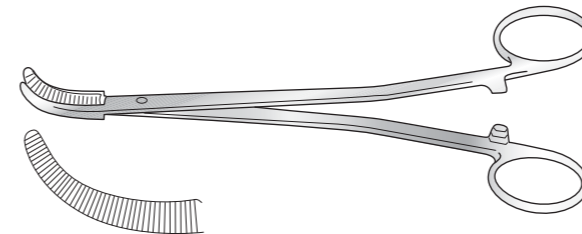

Code	Description
SC-IN/012	215mm long

**Kocher Intestinal Forceps**

With light spring blades and longitudinal serrations

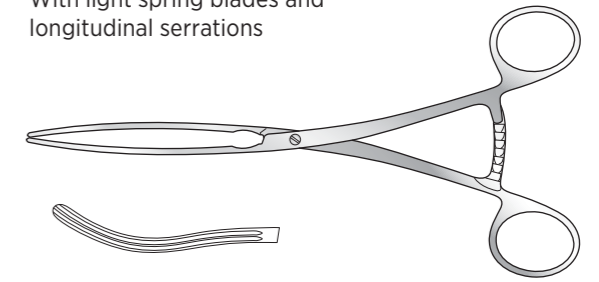

Code	Description
SC-IN/015a	Straight, 90mm blades, 210mm long
SC-IN/015b	Curved, 85mm blades, 210mm long

**Babcock Intestinal Forceps**

Straight, extra light

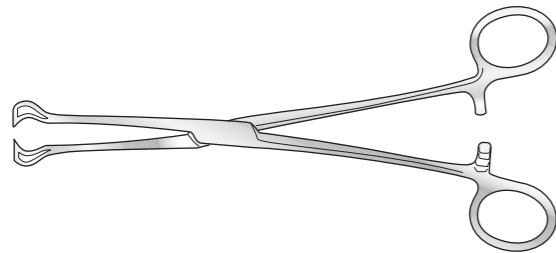

Code	Description
SC-GI/278	203mm long

**Lahey Cholecystectomy Forceps**

Curved, longitudinal serrations, heavier pattern

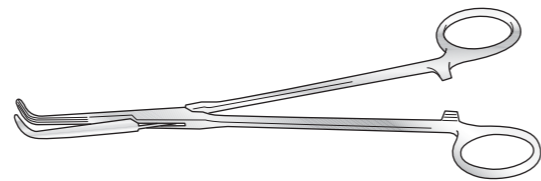

Code	Description
SC-IN/011	76mm blades, 197mm long
SC-IN/011a	225mm long

**Lane Intestinal Forceps**

110mm blades, longitudinal serrations  
240mm long

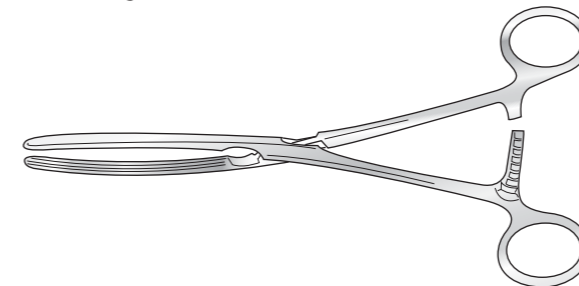

Code	Description
SC-IN/013	Straight
SC-IN/013b	Curved

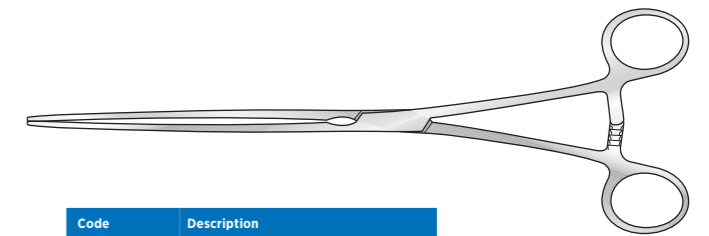

Code	Description
SC-IN/015c	Straight, 120mm blades, 250mm long
SC-IN/015d	Curved, 1150mm blades, 250mm long
SC-IN/015e	Straight, 150mm blades, 250mm long
SC-IN/015f	Curved, 145mm blades, 250mm long

**Maingot Intestinal Forceps**

Straight, serrated tip, fenestrated grip

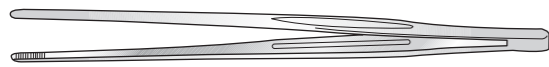

Code	Description
SC-IN/006	203mm long

**Lahey Sweet Forceps**

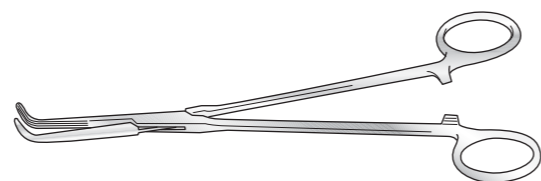

Code	Description
SC-IN/011b	200mm long
SC-IN/011c	225mm long
SC-IN/011d	230mm long

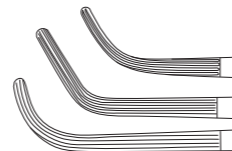

**Denis Browne Intestinal Forceps**

Straight, serrated tips, fenestrated jaws



Code	Description
SC-IN/007	178mm long

**Seton Pringle Intestinal Forceps**

Straight, longitudinal serrations  
178mm long

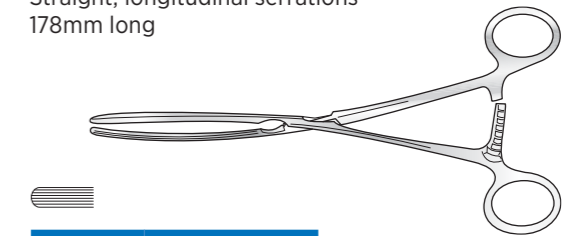

Code	Description
SC-IN/014	Fine blades 2.5mm wide



# Forceps and Clamps

## Lang Stevenson Intestinal Forceps

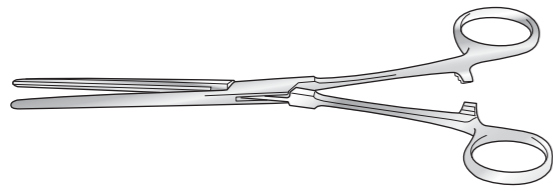

Code	Description
SC-IN/018	82mm jaw, keyed blades, 203mm long



## Schoemaker-Ogilvie Colectomy Forceps

Straight, hollow blades

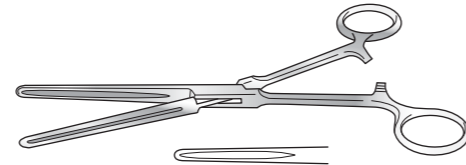

Code	Description
SC-IN/020	171mm long
SC-IN/020a	203mm long

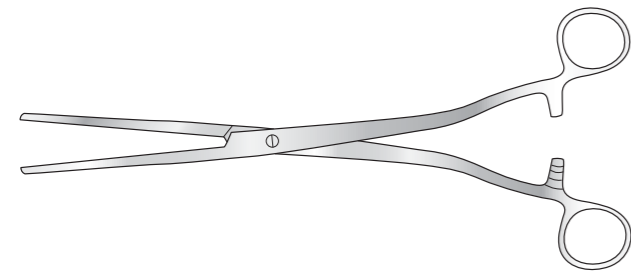

## Hartman Intestinal Clamp

With diagonal serrations, 200mm long

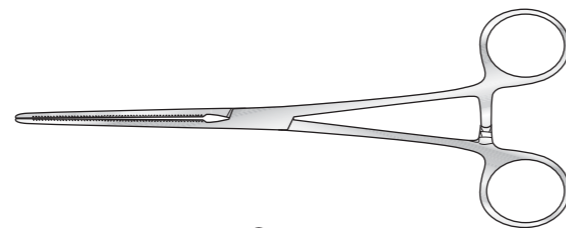

Code	Description
SC-IN/015g	Straight
SC-IN/015h	Curved

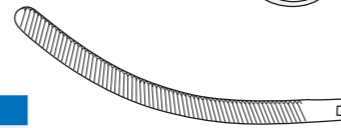

## Parker Kerr Intestinal Forceps/Clamp

Blades 89mm, 254mm long

Code	Description
SC-IN/017a	Curved
SC-IN/017c	Straight



## Guard/Shoe

SC-IN/017b curved, fenestrated inner or outer curve, 89mm

Code	Description
SC-IN/017d	Straight, 89mm

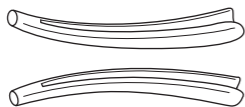

## Payr Intestinal Clamp

Crushing, lever action, longitudinal serrations

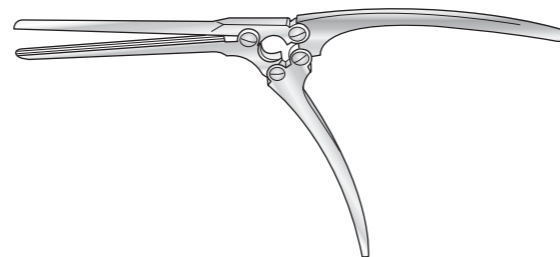

Code	Description
SC-IN/003	Extra small, 50mm blades, 150mm long
SC-IN/002a	Small, 65mm blades, 210mm long
SC-IN/002b	Medium, 100mm blades, 240mm long
SC-IN/002c	Large, 150mm blades graduated in inches, 360mm long

## Doyen Intestinal Clamp

240mm long

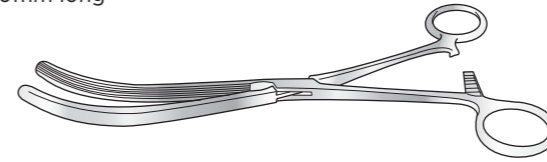

Code	Description
SC-IN/004a	Straight
SC-IN/004b	Curved

## Lane Twin Stomach Clamp

Longitudinal serrations large, 150mm blades, 305mm long

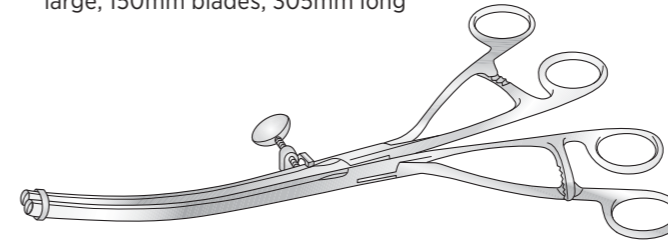

Code	Description
SC-IN/009b	Straight
SC-IN/009a	Curved

# Clamps and Miscellaneous

## Zachary Cope Anastomosis Clamp

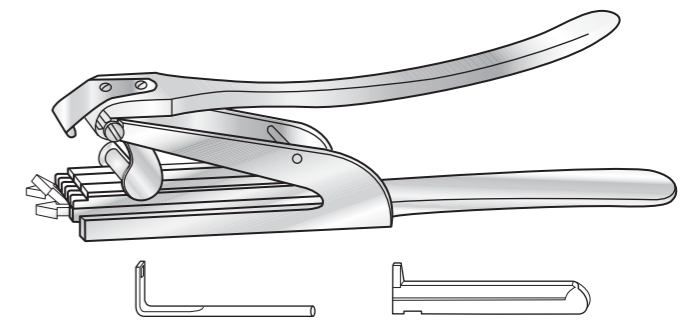

Code	Description
SC-IN/010a	Set: 3 clamps, lever action closing device and tommy bar, 233mm long
SC-IN/010b	Set of 3 clamps
SC-IN/010c	Tommy bar for set, 103mm long

## Bakes Bile Duct Dilators

Malleable stems, 203mm long



Code	Description	Code	Description
SC-IN/016a	Set of nine	SC-IN/016g	7mm ø head
SC-IN/016c	3mm ø head	SC-IN/016h	8mm ø head
SC-IN/016d	4mm ø head	SC-IN/016i	9mm ø head
SC-IN/016e	5mm ø head	SC-IN/016j	10mm ø head
SC-IN/016f	6mm ø head	SC-IN/016k	11mm ø head

## Yankauer Suction Tube

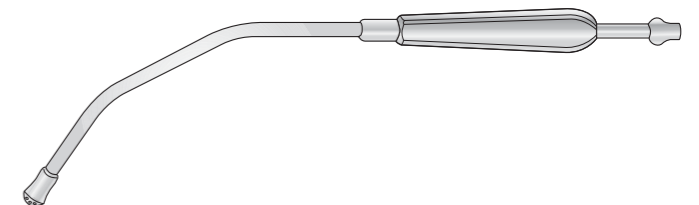

Code	Description
SC-IN/019	305mm long

## Taking care of your instruments

It is really important to ensure your instruments remain safe.

To do this, you will need a device which allows you to magnify distal areas of the instruments to check for:

- Burrs
- Corrosion
- Cracks



Contact us for more advice on taking care of your instruments [info@surgicalholdings.co.uk](mailto:info@surgicalholdings.co.uk)

# Neuro/ Spinal Surgery

Forceps	115
Scissors	117
Dissectors and Probes	118
Hooks and Curettes	119
Retractors	120
Elevators	123
Suction Tubes	124
Rongeurs	125

## Adson Dissecting Forceps

Bayonet, 1-2 teeth, jaw 2.5mm at tip

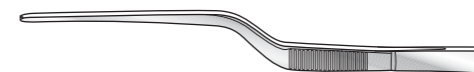

Code	Description
SC-NEU/001c	191mm long

## Jefferson Dressing Forceps



Code	Description
SC-NEU/013	Serrated jaws, 178mm long

## Adson Dissecting Forceps

Bayonet, fine, serrated jaws, jaw 2.5mm at tip



Code	Description
SC-NEU/009	178mm long

## Jefferson Forceps



Code	Description
SC-NEU/002	Fine, 1-2 teeth, 178mm long

## Northfield Dressing Forceps

Extra light, serrated jaws

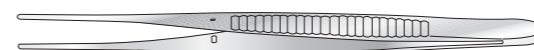

Code	Description
SC-NEU/014	1mm wide, 203mm long

## Pennybacker Dissecting Forceps

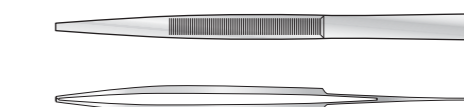

Code	Description
SC-NEU/005	3-4 teeth, 165mm long

## Forceps

### Silcock Iris Forceps

102mm long



Code	Description
SC-NEU/006	1-2 teeth
SC-NEU/015	Serrated jaws

### Cairns Dissecting Forceps

Delicate, 2-3 teeth



Code	Description
SC-NEU/003a	165mm long
SC-NEU/003b	216mm long

### Cairns (Dott) Dressing Forceps

Serrated jaws



Code	Description
SC-NEU/010	Medium, 2mm wide, 216mm long
SC-NEU/012	Fine, 1mm wide, 178mm long

### Dott Dissecting Forceps

Fine, 1-2 teeth



Code	Description
SC-NEU/004	178mm long

### Dott Dressing Forceps

Angled

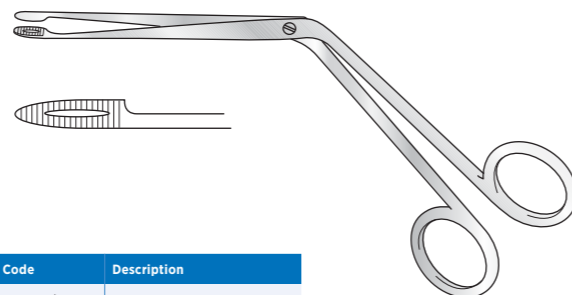

Code	Description
SC-NEU/018	114mm long

### Tilley Dressing Forceps

Angled, serrated ends

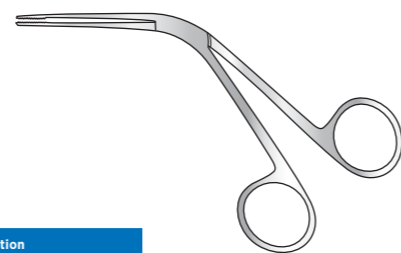

Code	Description
SC-NEU/017	89mm long

### Cairns Scissors

Angled on flat

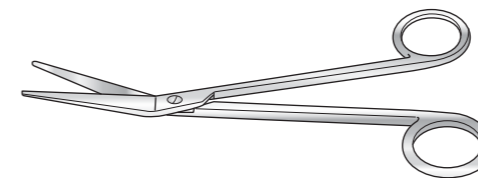

Code	Description
SC-NEU/020	178mm long

### McKissock Scissors

Straight

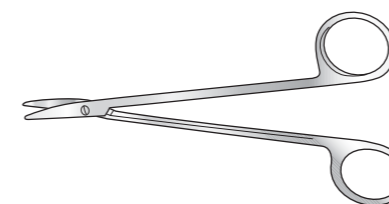

Code	Description
SC-NEU/021a	146mm long

### Olivecrona Scissors

Angled, with all micro serrated blade

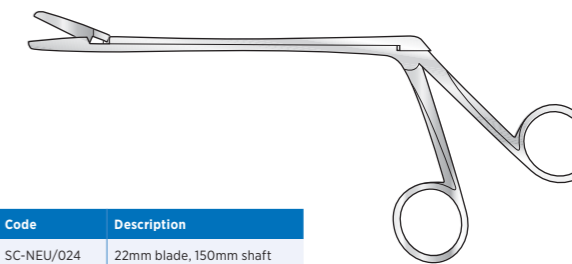

Code	Description
SC-NEU/024	22mm blade, 150mm shaft

### Schmieden (Taylor) Scissors

Angled, probe-pointed under blade

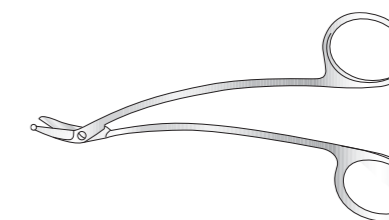

Code	Description
SC-NEU/023	146mm long

### Sweet Scissors

Delicate

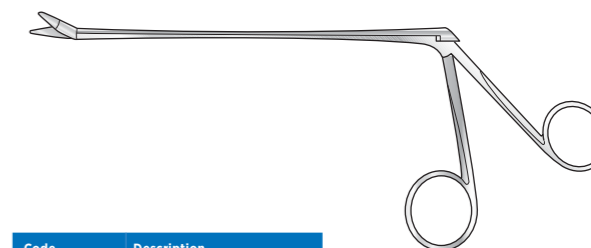

Code	Description
SC-NEU/025a	7mm blade, 144mm shaft
SC-NEU/030	13mm blade, 117mm shaft

## The Original Titanium Rhoton Dissector Set

from Symmetry Surgical

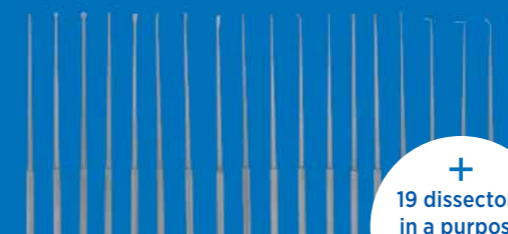

+  
19 dissectors  
in a purpose  
designed  
case

- ✓ Made from lightweight titanium for balance, durability and corrosion resistance
- ✓ Design features include round, deeply knurled handles which facilitate non-slip, finger-controlled micro manipulation

Order your set today  
[info@surgicalholdings.co.uk](mailto:info@surgicalholdings.co.uk)

## Scissors

## Dissectors and Probes

### Cairns Guide and Director

Malleable



Code	Description
SC-NEU/080	127mm long

### Dissector

200mm long



Code	Description
SC-NEU/N30210	Soft
SC-NEU/N30220	Soft, with hole

### Penfield Dissector



#### No 1

Broad curve, with 7.5mm sharp round spoon, 184mm long



#### No 2

7.5mm sharp round spoon with wax packer, 178mm long



#### No 3

Full curve and wax packer, 197mm long



#### No 4

Slight curve, 4mm wide, 216mm long

Code	Description
SC-NEU/069a	No 1
SC-NEU/069b	No 2
SC-NEU/069c	No 3
SC-NEU/069d	No 4

### Pennybacker Probe Dissector

Double ended



Code	Description
SC-NEU/101	229mm long

### Swedish Dissector

Double ended



Code	Description
SC-NEU/100a	Light model, 178mm long
SC-NEU/100b	Heavy model, 200mm long

### Watson Cheyne Dissector

Fine, double-ended, with probe end



Code	Description
SC-GI/287	127mm long
SC-GI/288	191mm long
SC-GI/288a	230mm long
SC-GI/288b	255mm long

## Hooks

### Adson Hook

178mm long



Code	Description
SC-NEU/078a	Angled
SC-NEU/078b	Straight
SC-NEU/078b-b	Straight, blunt

### Adson Oliver Neuro Hook

191mm long

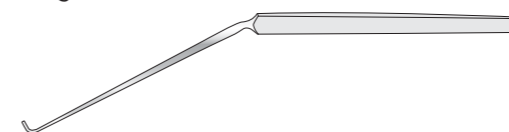

Code	Description
SC-NEU/082a	Angled downward, blunt
SC-NEU/082b	Sharp
SC-NEU/082c	Angled upward, blunt

### Cairns Tissue Hook

127mm long



Code	Description
SC-NEU/081b	Half round, sharp
SC-NEU/081c	Angled, sharp

### Oliver Tissue Hook

Blunt



Code	Description
SC-NEU/081a	127mm long

## Hooks and Curettes

## Curettes

### Falconer Scoop Curette

Double ended, angled ends



Code	Description
SC-NEU/099	191mm long

### American Spinal Fusion Curettes

Blue acetal handles, 254mm long

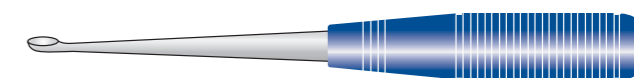

#### Straight

Code	Description
SC-NEU/074a	Size 000 2mm x 4mm
SC-NEU/074b	Size 00 2.5mm x 4.5mm
SC-NEU/074c	Size 0 2.75mm x 5mm
SC-NEU/074d	Size 1 3mm x 5.5mm
SC-NEU/074e	Size 2 3.25mm x 6mm
SC-NEU/074f	Size 3 4mm x 7mm
SC-NEU/074g	Size 4 6mm x 9.5mm
SC-NEU/074h	Size 5 7mm x 14mm
SC-NEU/074i	Size 6 9mm x 17mm

#### Angled

Code	Description
SC-NEU/074j	Size 000 2mm x 4mm
SC-NEU/074k	Size 00 2.5mm x 4.5mm
SC-NEU/074l	Size 0 2.75mm x 5mm
SC-NEU/074m	Size 1 3mm x 5.5mm
SC-NEU/074n	Size 2 3.25mm x 6mm
SC-NEU/074o	Size 3 4mm x 7mm
SC-NEU/074p	Size 4 6mm x 9.5mm
SC-NEU/074q	Size 5 7mm x 14mm
SC-NEU/074r	Size 6 9mm x 17mm

ALSO AVAILABLE WITH ACETAL SUREGRIP HANDLE  
ADD SUFFIX BH TO CATALOGUE NUMBER

## Retractors

### Mastoid Retractor

3 x 3 blunt hooks

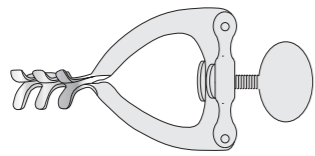

Code	Description
SC-NEU/N30350	114mm long

### Jansen (Shea) Retractor

Self retaining, blunt blades

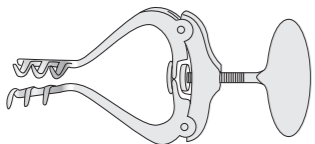

Code	Description
SC-NEU/028	114mm long

### Cone Retractor

Self retaining, hinged arms, for use in ventriculography

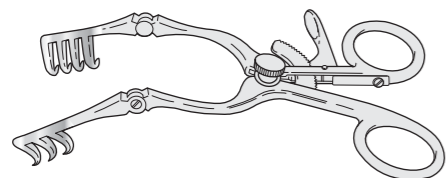

Code	Description
SC-NEU/027	165mm long

### Jefferson Retractor

Self retaining, curved, blunt pointed blades

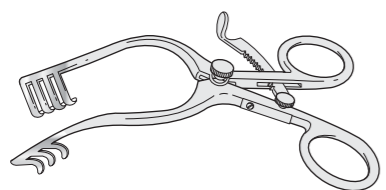

Code	Description
SC-NEU/029	140mm long

### Henderson Retractor

Self retaining, straight, 4 x 4 blunt pointed blades

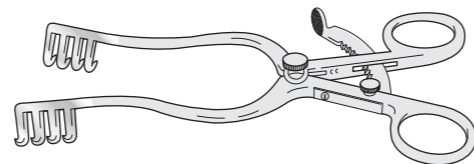

Code	Description
SC-NEU/030a	178mm long

### Cairns Scalp Retractor

Curved, self retaining, swivel blades

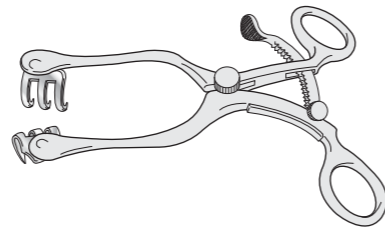

Code	Description
SC-NEU/025b	140mm long

### Schnitker Scalp Retractor

Curved, self retaining, blunt swivel blades

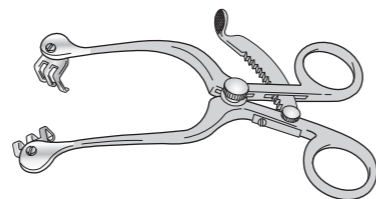

Code	Description
SC-NEU/026	140mm long

### Cone Laminectomy Retractor

Hinged arms, with cam rack

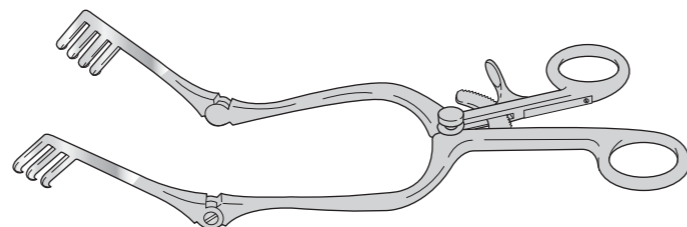

Code	Description
SC-NEU/051	254mm long

### Cone Laminectomy Retractor

Hinged arms

Code	Description
SC-NEU/052a	Left, 165mm long
SC-NEU/052b	Right, 165mm long
SC-NEU/052c	Left, 254mm long
SC-NEU/052d	Right, 254mm long

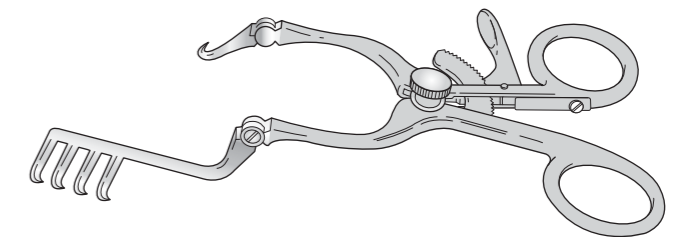

### Harvey-Jackson Laminectomy Retractor

Hinged arms, blades 38mm wide x 44mm deep

Code	Description
SC-NEU/053	305mm long

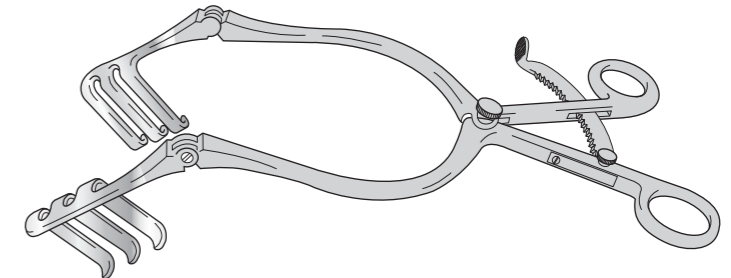

### Mayo-Adson (Beckmann) Laminectomy Retractor

Hinged arms

Code	Description
SC-NEU/054	292mm long

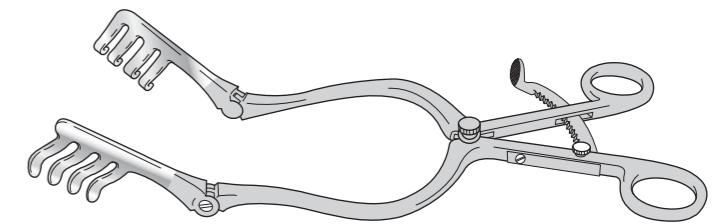

### Northfield (Cairns) Retractor

Hinged arms, one pair of blades

4 prong : 25mm wide x 16mm deep  
and one pair of blades

5 prong: 32mm wide x 25mm deep

Code	Description
SC-NEU/055	292mm long

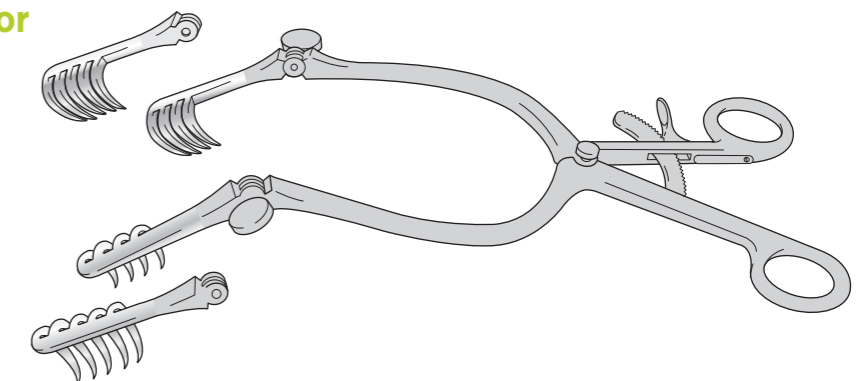

### Meyerding Hemi-Laminectomy Retractor

Code	Description
SC-NEU/216	18cm long 7" blade size 50 x 10mm
SC-NEU/219	18cm long 7" blade size 50 x 20mm
SC-NEU/217	18cm long 7" blade size 60 x 10mm
SC-NEU/220	18cm long 7" blade size 60 x 20mm
SC-NEU/218	18cm long 7" blade size 70 x 10mm
SC-NEU/221	18cm long 7" blade size 70 x 20mm
SC-NEU/224	18cm long blade left 90 x 10mm
SC-NEU/225	18cm long blades left 90 x 20mm
SC-NEU/222	18cm long blades right 90 x 10mm
SC-NEU/223	18cm long blades right 90 x 20mm

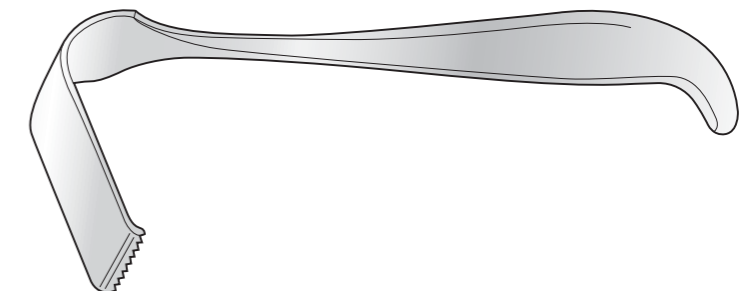

## Retractors

## Retractors

### Cairns-Northfield Laminectomy Retractor

203mm arm length with three pairs of interchangeable swivelling blades, 76mm, 64mm, and 51mm

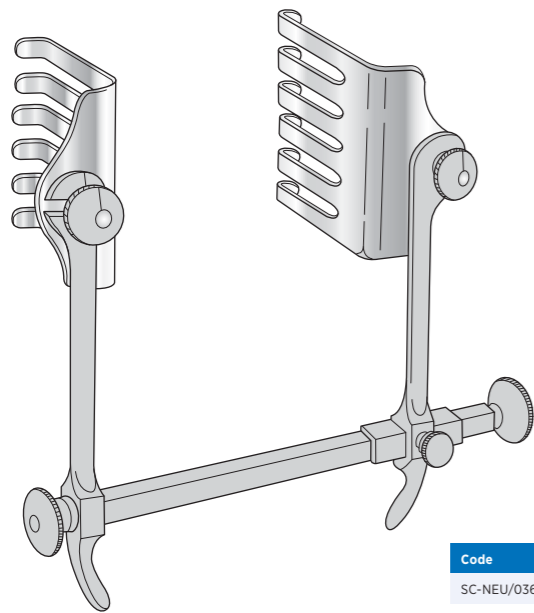

Code  
SC-NEU/036

### Cairns 'Rake' Scalp Retractor

Sharp, 210mm long

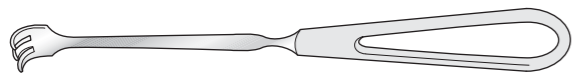

Code	Description
SC-NEU/032a	3 prong, 16mm wide
SC-NEU/032b	4 prong, 19mm wide

### Cairns (Cushing) Scalp Retractor

Solid blade

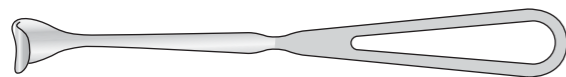

Code	Description
SC-NEU/033	16mm wide, 210mm long

### Cairns Strip Retractor

Malleable, 203mm long  
8 sizes: 6, 8, 10, 11, 13, 16, 19, 25mm



Code	Description
SC-NEU/034a	20 SWG
SC-NEU/034b	18 SWG

### Hibbs Retractor

203mm long

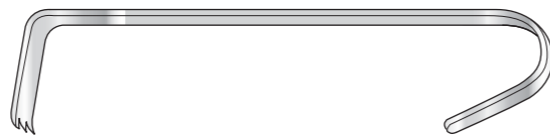

Code	Description
SC-NEU/050a	Blades 10mm x 38mm
SC-NEU/050b	Blades 16mm x 54mm

### Krayenbuhl Retractor

6mm wide

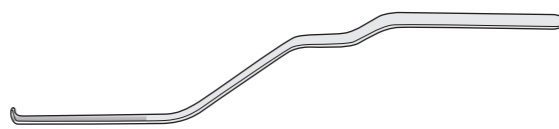

Code	Description
SC-NEU/5905	210mm long
SC-NEU/5905a	240mm long

### Love Retractor

6mm wide

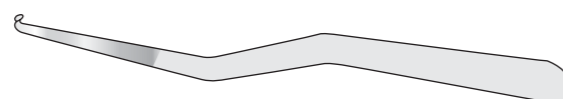

Code	Description
SC-NEU/5905b	210mm long

### Love Retractor

203mm long



Code	Description
SC-NEU/077a	Straight, blade 5mm x 5mm
SC-NEU/077b	Shaft angled 90° at handle
SC-NEU/077c	Shaft angled 45° at handle

### O'Connell Retractor

Double ended



Code	Description
SC-NEU/076	216mm long

## Elevators

### Cobb Spinal Elevator

13mm wide, knurled handle

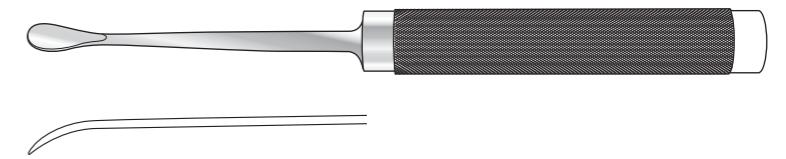

### Cobb Spinal Elevator

With blue acetal handles, 279mm long

Code	Description
SC-NEU/073a	10mm wide
SC-NEU/073b	13mm wide
SC-NEU/073c	19mm wide

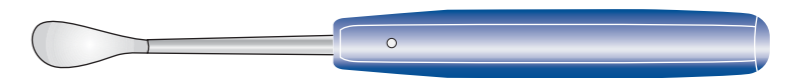

ALSO AVAILABLE WITH ACETAL SUREGRIP HANDLE  
ADD SUFFIX BH TO CATALOGUE NUMBER

### Adson Periosteal Elevator

Serrated grip, 165mm long

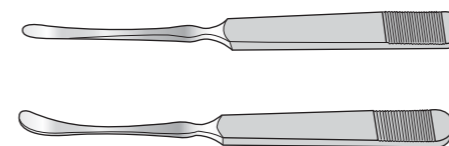

straight

Code	Description
SC-OR/N028	7mm wide

curved

Code	Description
SC-OR/N029	5mm wide
SC-OR/N030	7mm wide

### McKissock Spade Periosteal Elevator

Straight



Code	Description
SC-NEU/072	197mm long

### Cushing Periosteal Elevator

Slightly curved end



Code	Description
SC-NEU/071	197mm long

### Pennybacker Elevator

Curved, sharp, 171mm long

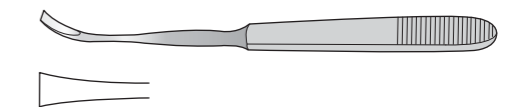

Code	Description
SC-OR/N025	6mm wide

# Suction Tubes

## Adson Frazier Suction Tube

Angled, fully insulated, 180mm long

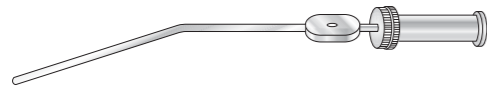

Code	Description
SC-NEU/094c	8 F.G.

## Retractor Suction Tube

With stilette, 220mm long

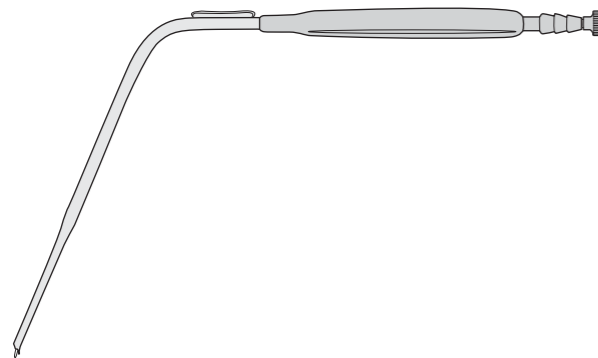

Code	Description
SC-NEU/SK001STIL	Replacement stilette

## Frazier Suction Tubes

Malleable, silver, angled, 180mm long

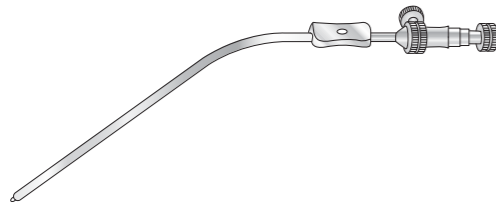

Code	Description
SC-NEU/092a	7 F.G.
SC-NEU/092b	8 F.G.
SC-NEU/092c	9 F.G.

## Dandy Rongeur

Straight

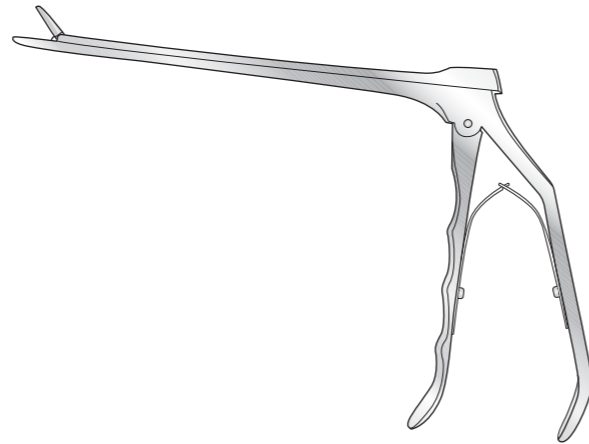

Code	Description
SC-NEU/134	3mm bite, 178mm shaft

## Falconer Rongeur

Oblique jaws

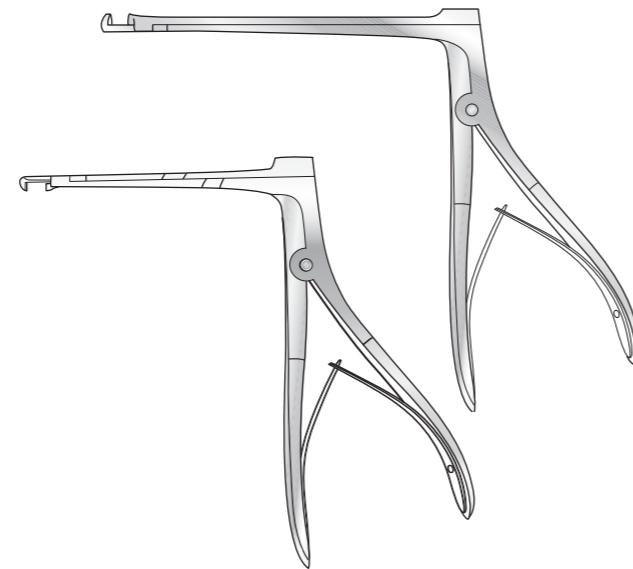

Code	Description
SC-NEU/122a	Upward cutting, 3mm bite, 110mm shaft
SC-NEU/122b	Upward cutting, 5mm bite, 110mm shaft
SC-NEU/122c	Downward cutting, 3mm bite, 85mm shaft
SC-NEU/122d	Downward cutting, 5mm bite, 110mm shaft

## Beck Rongeur

Straight, for intervertebral disc

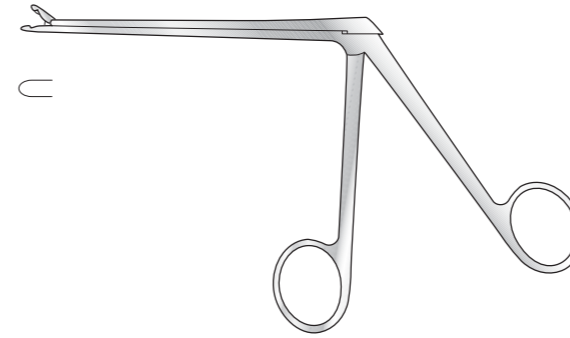

Code	Description
SC-NEU/125	2mm bite, 130mm shaft

## Cushing Rongeur

130mm shaft

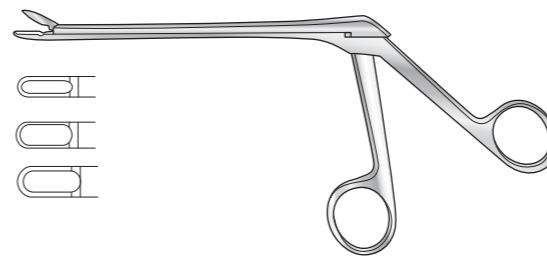

Code	Description
SC-NEU/127-2	2mm bite
SC-NEU/127-3	3mm bite
SC-NEU/127-4	4mm bite
SC-NEU/127-5	5mm bite
SC-NEU/127-6	6mm bite

## Cushing Rongeur

130mm shaft

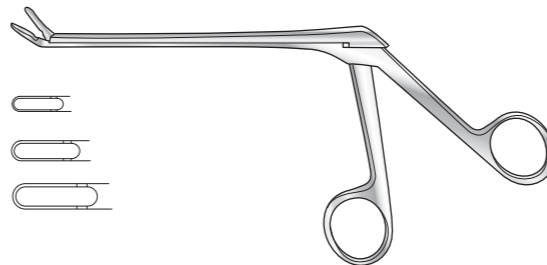

### 150° upward cutting

Code	Description
SC-NEU/128c	2mm bite
SC-NEU/128	3mm bite
SC-NEU/128a	4mm bite
SC-NEU/128b	5mm bite

### 150° downward cutting

Code	Description
SC-NEU/130c	2mm bite
SC-NEU/130	3mm bite
SC-NEU/130a	4mm bite
SC-NEU/130b	5mm bite

## Love-Grunwald Rongeur

Cup shaped, jaws 3mm x 10mm, 178mm shaft

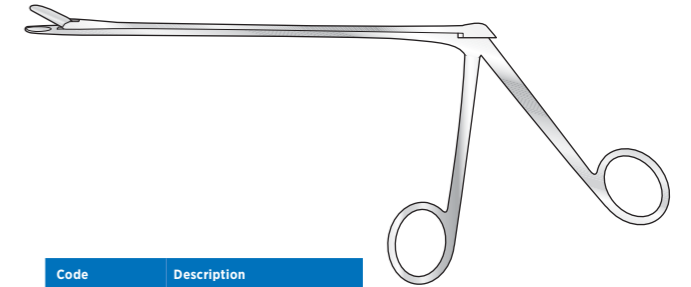

Code	Description
SC-NEU/131a	Straight
SC-NEU/131b	Curved upward
SC-NEU/131c	Curved downward

## Mackay Rongeur

140°, straight, 114mm shaft

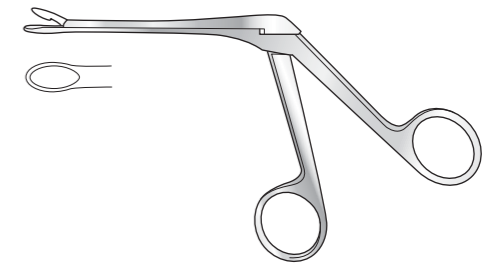

Code	Description
SC-SH/4249	5.5mm

## Northfield Rongeur

Curved, upward cutting

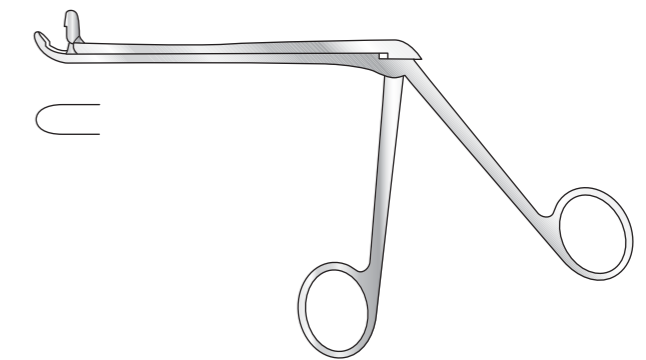

Code	Description
SC-NEU/132	4mm bite, 133mm shaft

# Rongeurs

## Rongeurs

## Pennybacker Rongeur

120mm shaft

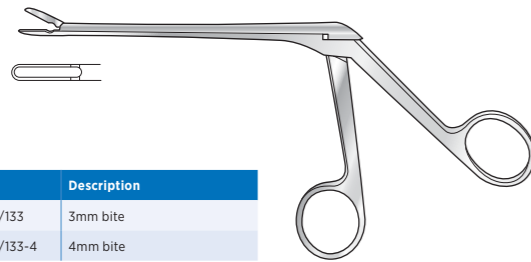

Code	Description
SC-NEU/133	3mm bite
SC-NEU/133-4	4mm bite

## Daniel Rongeur

Miniature, for neuropathology

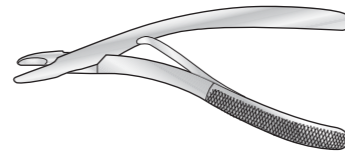

Code	Description
SC-NEU/104	1.5mm bite, 127mm long

## Wilms Rongeur

Angled on flat, narrow jaws

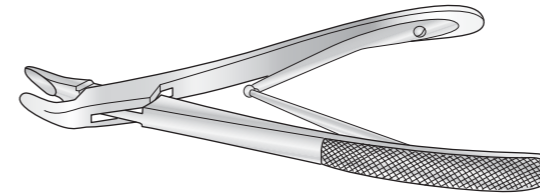

Code	Description
SC-NEU/114	4mm bite, 203mm long

## Pennybacker Rongeur

Straight, fine jaws, 203mm long

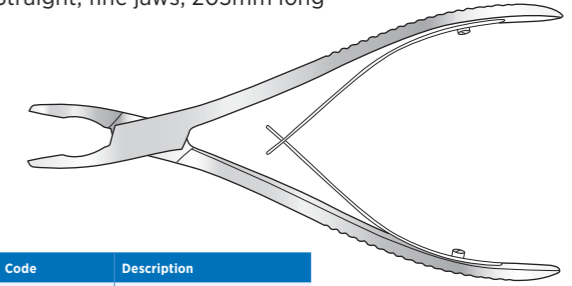

Code	Description
SC-NEU/107	4mm bite

## St Bart's Rongeur

114mm shaft

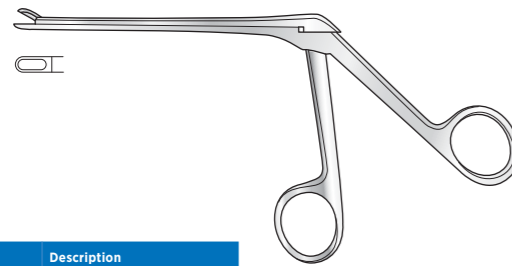

Code	Description
SC-ENT/140a	3mm bite

## Cairns Rongeur

Fine jaws, angled on flat, serrated jaws, curved handles

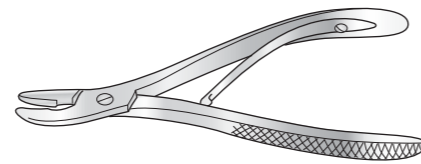

Code	Description
SC-NEU/103	4mm bite 152mm long

## Glasgow Pattern Rongeur

Slightly curved on flat, screw joint

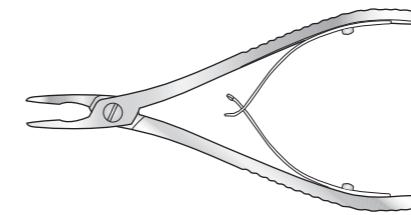

Code	Description
SC-NEU/111	4mm bite, 146mm long

## Northfield Rongeur

Straight, 10mm bite

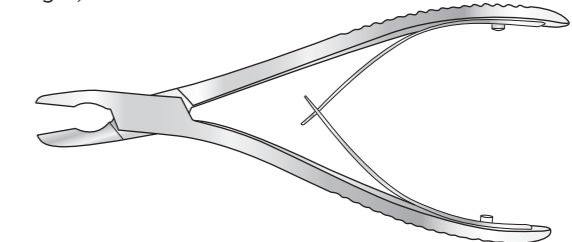

Code	Description
SC-NEU/106	One shallow blade, 200mm long

## St Bart's Rongeur

140°, downward cutting, 114mm shaft

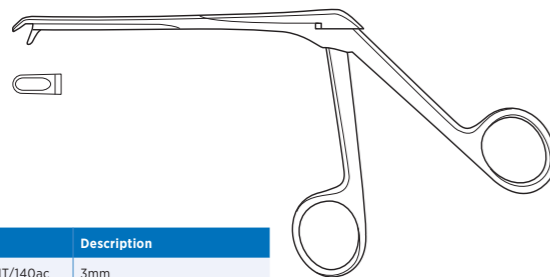

Code	Description
SC-ENT/140ac	3mm

## Danish Pattern Rongeur

Angled on flat, fine jaws, curved handles, screw joint

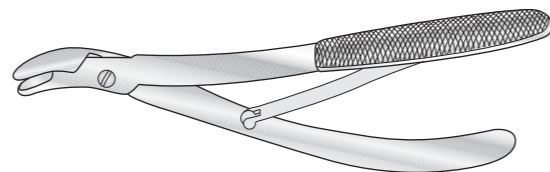

Code	Description
SC-NEU/109	4mm bite, 203mm long

## Heanley Rongeur

Long fine straight jaws, screw joint

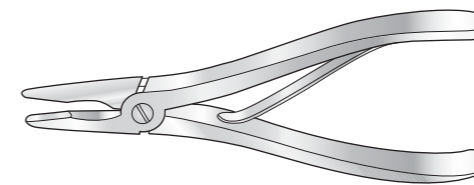

Code	Description
SC-NEU/112	4mm bite, 178mm long

## Stookey Rongeur

Angled to side, fine jaws

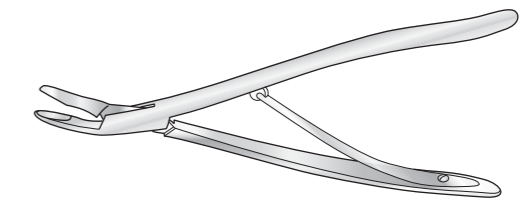

Code	Description
SC-NEU/108	3mm bite, 178mm long

## St Bart's Rongeur

140°, upward cutting, 114mm shaft

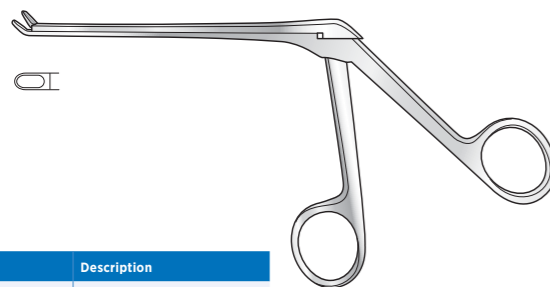

Code	Description
SC-ENT/140b	3mm

## Falconer Rongeur

Angled to side, light, screw joint

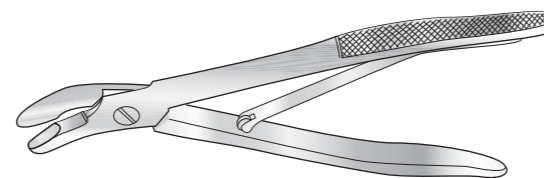

Code	Description
SC-NEU/110	6mm bite, 203mm long

## Jansen Rongeur

Short curve, screw joint

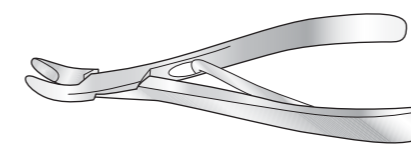

Code	Description
SC-NEU/105	8mm bite, 152mm long

## Trotter Rongeur

Angled to side, strong, screw joint

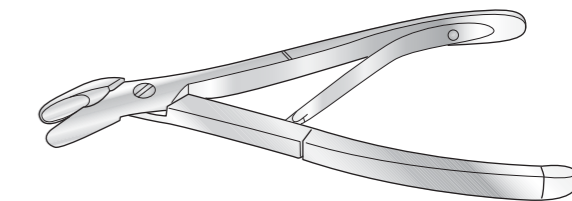

Code	Description
SC-NEU/113	10mm bite, 203mm long

## Rongeurs



# Rongeurs

## Luer-Jansen Rongeur

Light, curved on flat, compound action

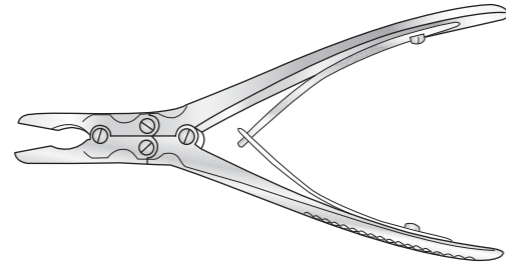
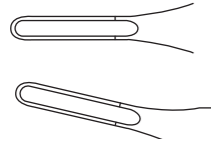

Code	Description
SC-NEU/116	4mm bite, 197mm long

## Olivecrona Rongeur

Angled to side, compound action, 229mm long

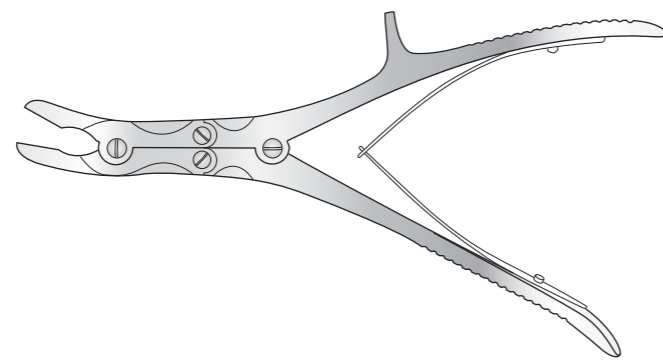

Code	Description
SC-NEU/119a	5mm bite
SC-NEU/119b	6mm bite

## Ruskin Rongeur

Curved on flat, compound action

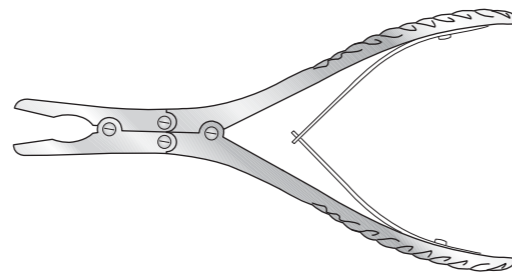

Code	Description
SC-NEU/118	6mm bite, 184mm long

## Leksell Rongeur

Curved to side, compound action

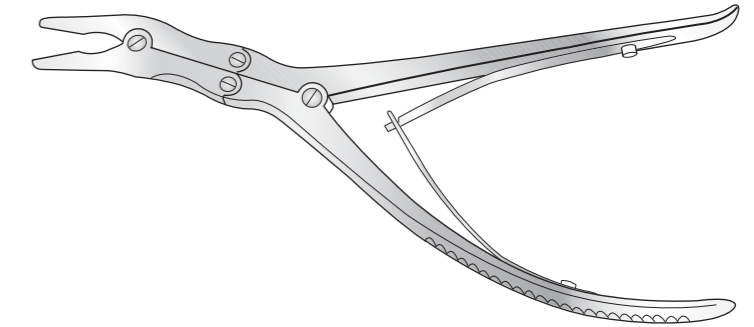
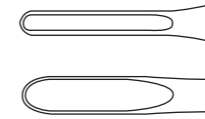

Code	Description
SC-NEU/115a	Small, 6mm bite, 229mm long
SC-NEU/115b	Large, 8mm bite, 254mm long

## Luer Stille Bone Rongeur

Curved, 250mm long

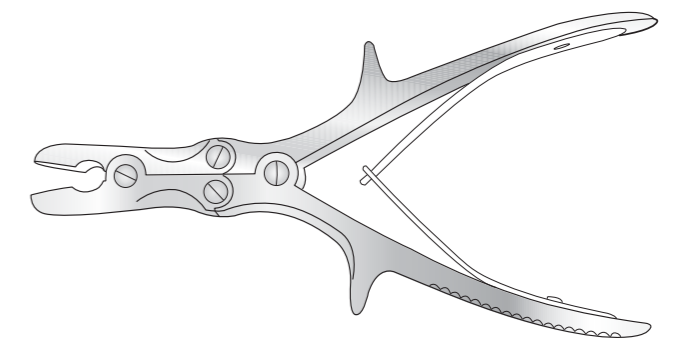
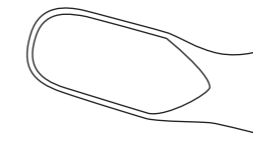

Code	Description
SC-OR/071b	11mm bite
SC-NEU/117	Heavy, 229mm long

## Swedish Pattern Laminectomy Shears

Double crank, compound action

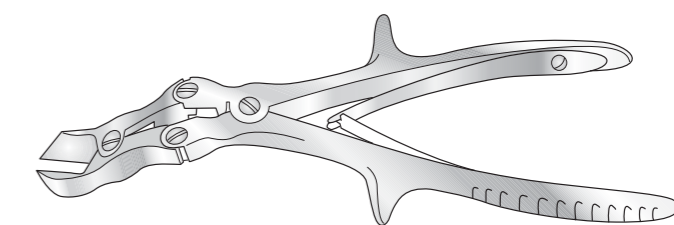

Code	Description
SC-NEU/121	267mm long

# Rongeurs

# Rongeurs

## Kerrison Rongeurs

Cloward disc punch (not illustrated)  
130° upward cutting, 190mm long

BLACK CERAMIC COATED KERRISONS AVAILABLE  
PLEASE ADD SUFFIX -BK WHEN ORDERING

Code	Description
SC-NEU/CL002	2mm wide
SC-NEU/CL003	3mm wide
SC-NEU/CL004	4mm wide
SC-NEU/CL005	5mm wide
SC-NEU/CL006	6mm wide



Kerrison punch

1mm 2mm 3mm 4mm 5mm

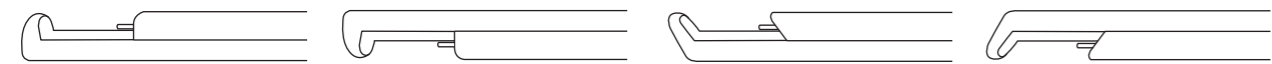

## Non-Detachable

### 90° upward cutting

Code	Description
SC-NEU/136	180mm(L) x 1mm(W)
SC-NEU/137	180mm(L) x 2mm(W)
SC-NEU/138	180mm(L) x 3mm(W)
SC-NEU/139	180mm(L) x 4mm(W)
SC-NEU/140	180mm(L) x 5mm(W)
SC-NEU/141	230mm(L) x 2mm(W)
SC-NEU/142	230mm(L) x 3mm(W)
SC-NEU/143	230mm(L) x 4mm(W)
SC-NEU/144	230mm(L) x 5mm(W)

### 90° downward cutting

Code	Description
SC-NEU/154	180mm(L) x 1mm(W)
SC-NEU/155	180mm(L) x 2mm(W)
SC-NEU/156	180mm(L) x 3mm(W)
SC-NEU/157	180mm(L) x 4mm(W)
SC-NEU/158	180mm(L) x 5mm(W)
SC-NEU/159	230mm(L) x 2mm(W)
SC-NEU/160	230mm(L) x 3mm(W)
SC-NEU/161	230mm(L) x 4mm(W)
SC-NEU/162	230mm(L) x 5mm(W)

### 130° upward cutting

Code	Description
SC-NEU/172	180mm(L) x 1mm(W)
SC-NEU/173	180mm(L) x 2mm(W)
SC-NEU/174	180mm(L) x 3mm(W)
SC-NEU/175	180mm(L) x 4mm(W)
SC-NEU/176	180mm(L) x 5mm(W)
SC-NEU/177	200mm(L) x 3mm(W)
SC-NEU/178	200mm(L) x 4mm(W)
SC-NEU/179	200mm(L) x 5mm(W)
SC-NEU/180	200mm(L) x 6mm(W)
SC-NEU/181	230mm(L) x 2mm(W)
SC-NEU/182	230mm(L) x 3mm(W)
SC-NEU/183	230mm(L) x 4mm(W)
SC-NEU/184	230mm(L) x 5mm(W)

### 130° downward cutting

Code	Description
SC-NEU/198	180mm(L) x 1mm(W)
SC-NEU/199	180mm(L) x 2mm(W)
SC-NEU/200	180mm(L) x 3mm(W)
SC-NEU/201	180mm(L) x 4mm(W)
SC-NEU/202	180mm(L) x 5mm(W)
SC-NEU/203	230mm(L) x 2mm(W)
SC-NEU/204	230mm(L) x 3mm(W)
SC-NEU/205	230mm(L) x 4mm(W)
SC-NEU/206	230mm(L) x 5mm(W)

## Detachable

### 90° upward cutting

Code	Description
SC-NEU/145	180(L) x 1mm(W)
SC-NEU/146	180(L) x 2mm(W)
SC-NEU/147	180(L) x 3mm(W)
SC-NEU/148	180(L) x 4mm(W)
SC-NEU/149	180(L) x 5mm(W)
SC-NEU/150	230(L) x 2mm(W)
SC-NEU/151	230(L) x 3mm(W)
SC-NEU/152	230(L) x 4mm(W)
SC-NEU/153	230(L) x 5mm(W)

### 90° downward cutting

Code	Description
SC-NEU/163	180(L) x 1mm(W)
SC-NEU/164	180(L) x 2mm(W)
SC-NEU/165	180(L) x 3mm(W)
SC-NEU/166	180(L) x 4mm(W)
SC-NEU/167	180(L) x 5mm(W)
SC-NEU/168	230(L) x 2mm(W)
SC-NEU/169	230(L) x 3mm(W)
SC-NEU/170	230(L) x 4mm(W)
SC-NEU/171	230(L) x 5mm(W)

### 130° upward cutting

Code	Description
SC-NEU/185	180(L) x 1mm(W)
SC-NEU/186	180(L) x 2mm(W)
SC-NEU/187	180(L) x 3mm(W)
SC-NEU/188	180(L) x 4mm(W)
SC-NEU/189	180(L) x 5mm(W)
SC-NEU/190	200(L) x 3mm(W)
SC-NEU/191	200(L) x 4mm(W)
SC-NEU/192	200(L) x 5mm(W)
SC-NEU/193	200(L) x 6mm(W)
SC-NEU/194	230(L) x 2mm(W)
SC-NEU/195	230(L) x 3mm(W)
SC-NEU/196	230(L) x 4mm(W)
SC-NEU/197	230(L) x 5mm(W)

### 130° downward cutting

Code	Description
SC-NEU/207	180(L) x 1mm(W)
SC-NEU/208	180(L) x 2mm(W)
SC-NEU/209	180(L) x 3mm(W)
SC-NEU/210	180(L) x 4mm(W)
SC-NEU/211	180(L) x 5mm(W)
SC-NEU/212	230(L) x 2mm(W)
SC-NEU/213	230(L) x 3mm(W)
SC-NEU/214	230(L) x 4mm(W)
SC-NEU/215	230(L) x 5mm(W)

## Symmetry Sharp Kerrison®

Your biggest Kerrison challenges solved with one product:

- Productive bite every time
- Never have to use a dull Kerrison again
- Minimise the risk of dural tears
- Reduce hand and arm fatigue
- Easily opened for cleaning
- No need to open multiple trays

Contact us for more details [info@surgicalholdings.co.uk](mailto:info@surgicalholdings.co.uk)



symmetry surgical  
authorised distributor

# Ophthalmic/ Micro

Forceps	132
Scissors	134
Needle Holders	136
Retractors	137
Speculum	137
Cannula	137
Miscellaneous	138

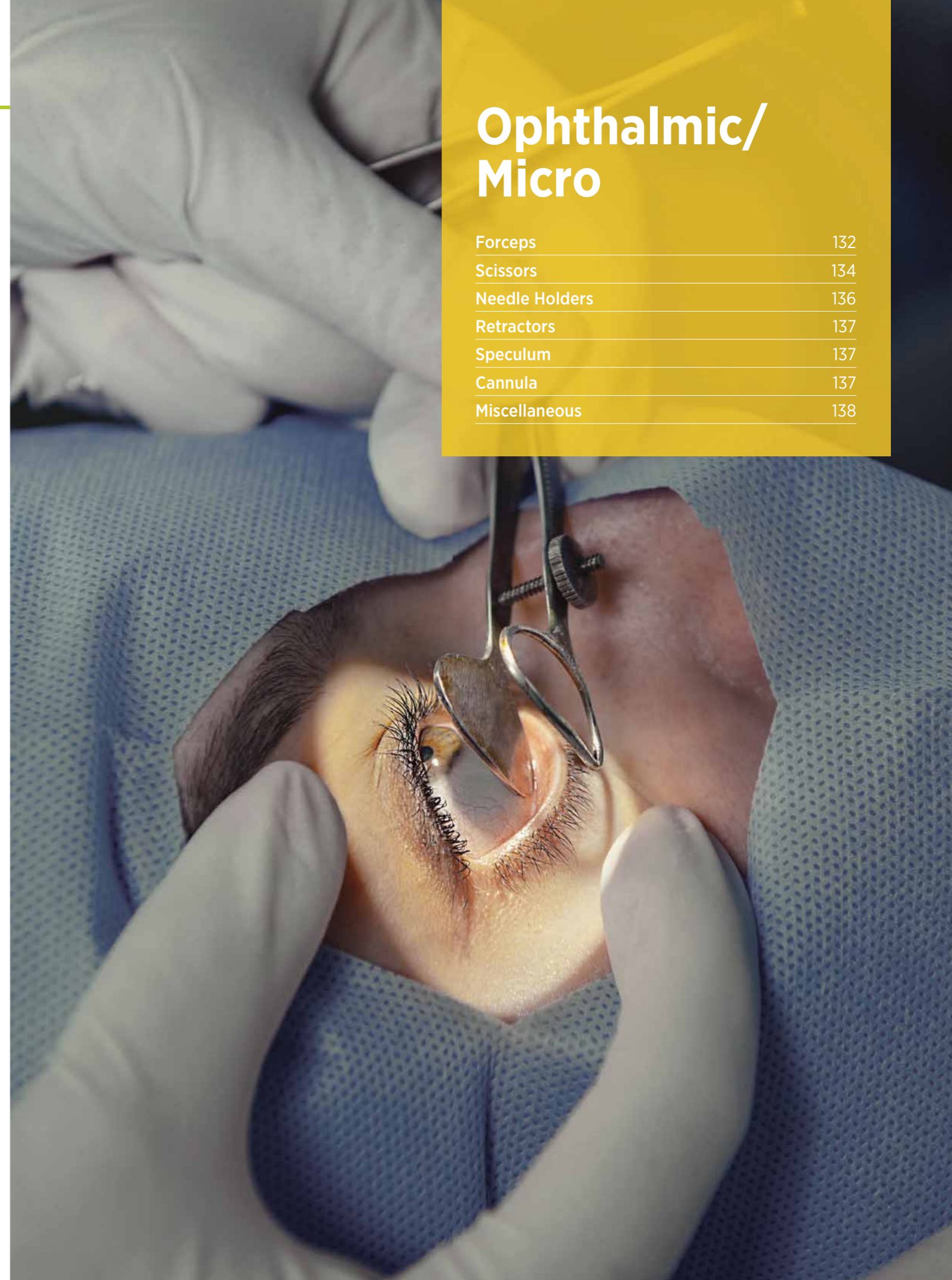

**Iris Forceps**

1-2 teeth, 114mm long

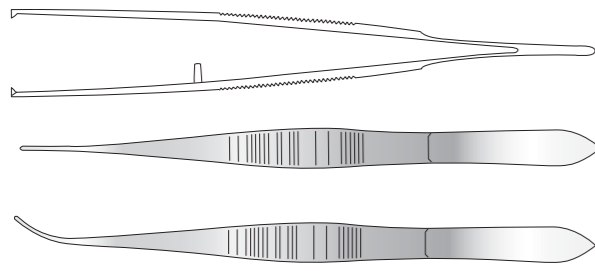

Code	Description
SC-OP/01	Straight
SC-SC-OP/02	Curved

**Iris Forceps**

Serrated, 114mm long

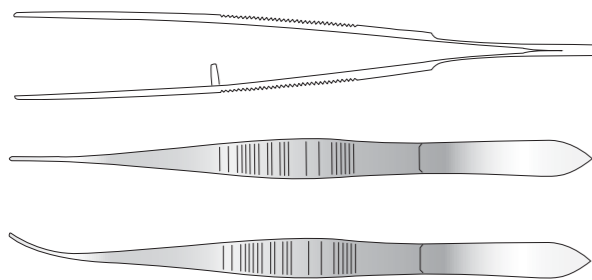

Code	Description
SC-OP/03	Straight
SC-OP/04	Curved

**Iris Forceps**

Extra fine, serrated, 94mm long

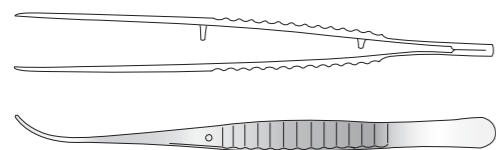

Code	Description
SC-OP/06	Curved

**Iris Fixation Forceps**

Extra fine, 1-2 teeth, 102mm long

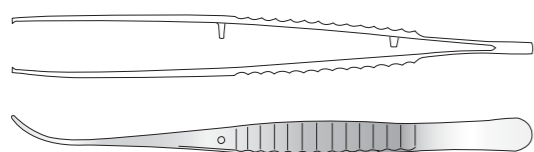

Code	Description
SC-OP/05	Curved

**Barraquer Corneal Forceps**

76mm long

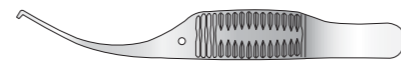

Code	Description
SC-OP/023	1-2 teeth

**Epilation Forceps**

89mm long

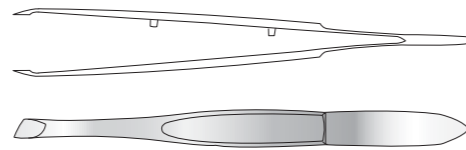

Code	Description
SC-OP/07	Oblique jaw

**Epilation Forceps**

89mm long

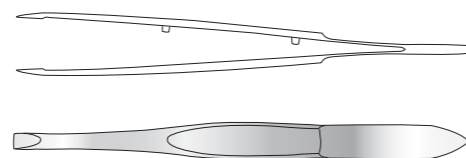

Code	Description
SC-OP/08	Straight ends, 3mm wide
SC-OP/08a	Round ends, 3mm wide

**Suture/Dissecting Forceps**

102mm long

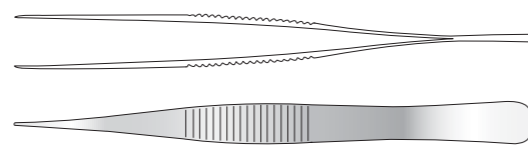

Code	Description
SC-OP/09	Extra fine

**Barraquer Fixation Forceps**

102mm long

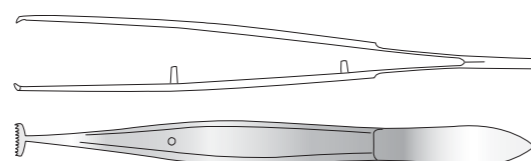

Code	Description
SC-OP/09a	9-10 teeth

**Jameson Evans Cilia Forceps**

120mm long

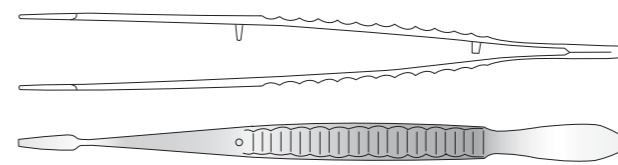

Code	Description
SC-OP/012	

**Tarsal Cyst Forceps**

89mm long

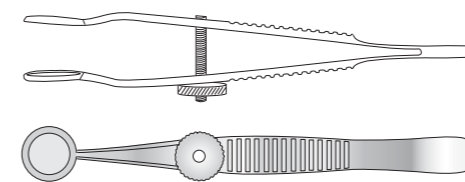

Code	Description
SC-OP/015	Round ends

**St Martin Corneal Suturing Forceps**

1-2 teeth, 89mm long

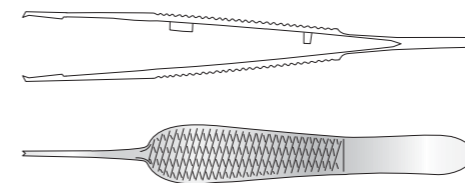

Code	Description
SC-OP/022	For fine work

**St Martin Micro Corneal Suturing Forceps**

1-2 teeth, 89mm long

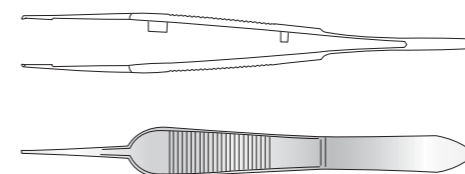

Code	Description
SC-OP/022a	Fine pattern

**Castroviejo Corneal Suture Forceps**

94mm long

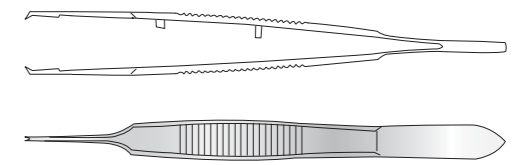

Code	Description
SC-OP/013	1-2 teeth

**Arruga Intra Capsule Forceps**

For removal of residual lens material during extra-capsula extraction, 120mm long

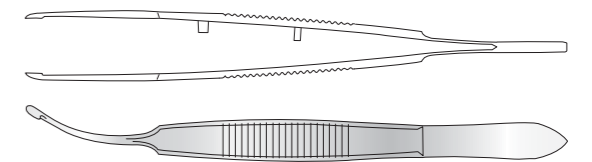

Code	Description
SC-OP/024	Curved tips

**Desmarre Entropian Forceps**

89mm long

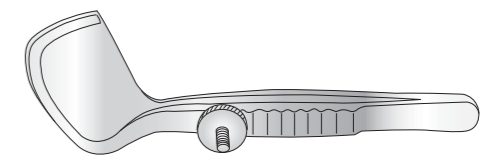

Code	Description
SC-OP/014	Right eye
SC-OP/014a	Left eye

**Wilde Entropian Forceps**

3 sizes, 89mm long

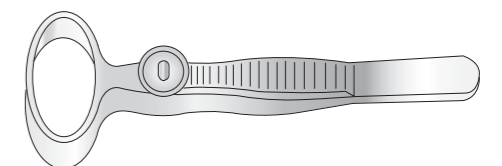

Code	Description
SC-OP/015a	With screw action

**de Wecker Iris Scissors**

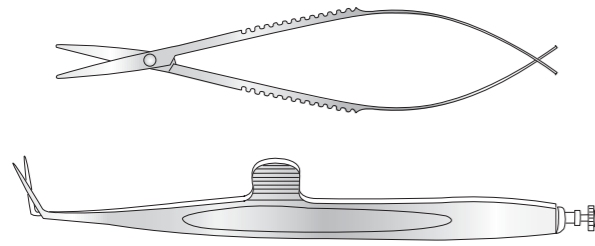

Code	Description
SC-OP/031	114mm long

**Castroviejo Scissors**

102mm long

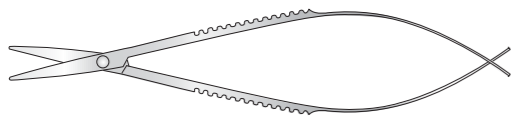

Code	Description
SC-OP/025	Curved

**Barraquer Iris Scissors**

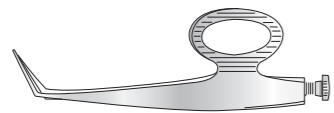

Code	Description
SC-OP/031a	62mm long

**Iris Scissors**

102mm long

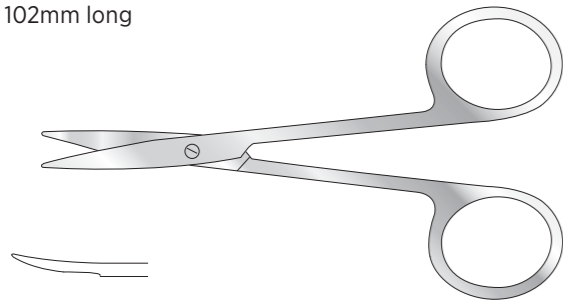

Code	Description
SC-OP/032	Straight
SC-OP/033	Curved

**Pooley Conjunctival Scissors**

89mm long

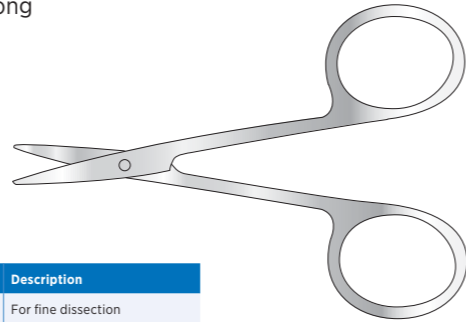

Code	Description
SC-OP/017	For fine dissection

**Thomas Strabismus Scissors**

114mm long

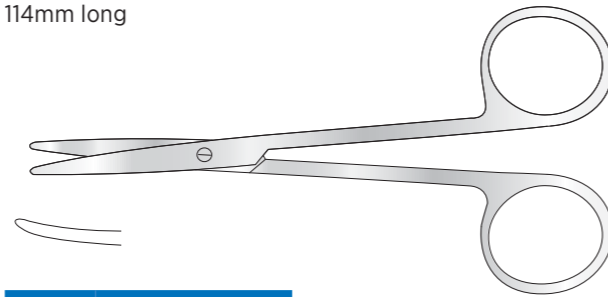

Code	Description
SC-OP/029	Straight
SC-OP/030	Curved

**Strabismus Scissors**

Supercut, 114mm long

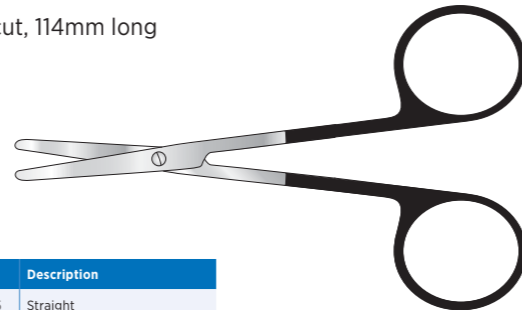

Code	Description
SC-GI/475	Straight
SC-GI/475a	Curved

**Iris Scissors**

Supercut, 114mm long

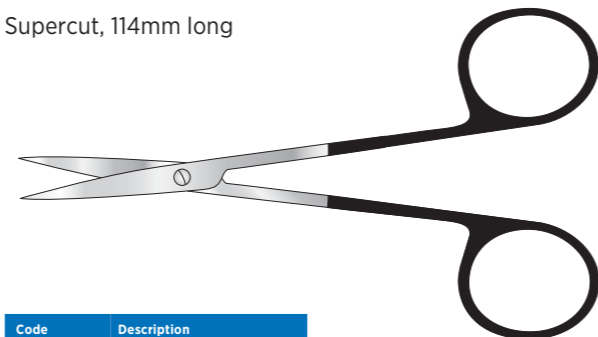

Code	Description
SC-OP/0476	Straight
SC-OP/0476a	Curved

**Westcott Scissors**

120mm long

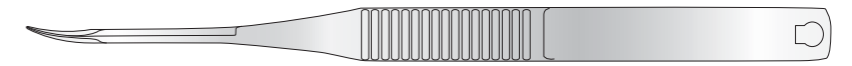

Code	Description
SC-OP/251	Curved, blunt
SC-OP/249	Curved, sharp
SC-OP/250	Straight, blunt
SC-OP/248	Straight, sharp

**Vannas Scissors**

**Scissors**

Code	Description
SC-OP/241	Blunt, curved 45°, 110mm
SC-OP/245	Curved 85mm
SC-OP/244	Straight 85mm
SC-OP/246	Strongly curved 85mm



**Micro Scissors**

Code	Description
SC-OP/278	Delicate, straight, 85mm
SC-OP/280	Delicate, curved, 85mm
SC-OP/279	Delicate, strongly curved in plane, 85mm

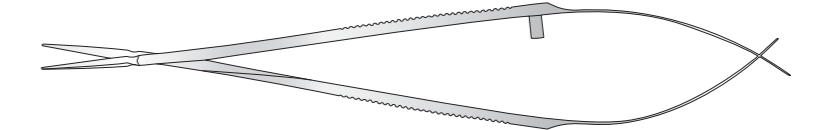

Did you know...

**The history of our family business**

We've had a long tradition of surgical instrument makers in the Coole family, going back way before our Managing Director, Daniel, was even born.

Fred Coole, started his ophthalmic instrument making business back in 1940. Instrument workshops used to be in the West End of London, close to key hospital sites.

Instrument makers would go to work dressed in 3 piece suits, as they would have to walk through showrooms where surgeons would be viewing instruments.



# Needle Holders

## Castroviejo Needle Holder

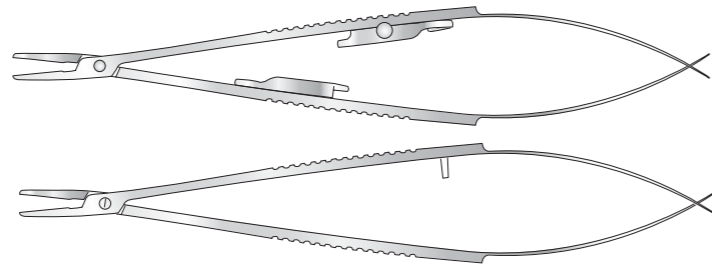

Code	Description
SC-OP/021	140mm long, with catch
SC-OP/020	140mm long, without catch

### Diamond dust jaws

Code	Description
SC-THO/060	180mm long, without catch
SC-THO/061	200mm long, without catch
SC-THO/062	215mm long, without catch



ALSO AVAILABLE WITH CATCH - ADD SUFFIX CTH TO CODE

### Tungsten carbide jaws

Code	Description
SC-THO/058a	180mm long
SC-THO/058	200mm long
SC-THO/059	215mm long

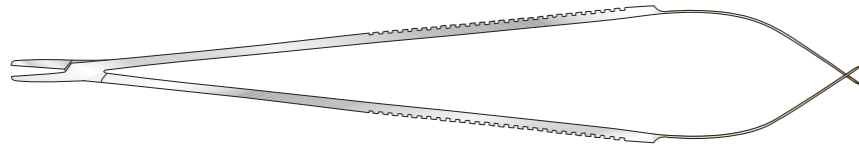

ALSO AVAILABLE WITH CATCH - ADD SUFFIX CTH TO CODE

## Silcock Needle Holder

140mm long

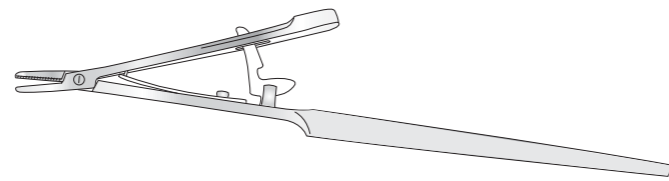

Code	Description
SC-OP/21a	With catch
SC-OP/20	Without catch

## Micro Needle Holder

Round knurled handle, 120mm long

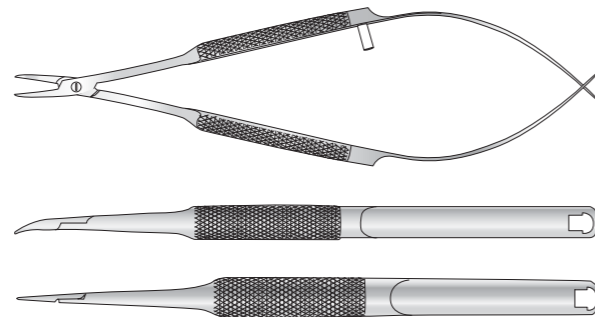

Code	Description
SC-OP/YA4020	Curved, without catch
SC-OP/YA4050	Curved, with catch
SC-OP/WA2010	Straight, without catch

## Micro Needle Holder

Curved, without catch

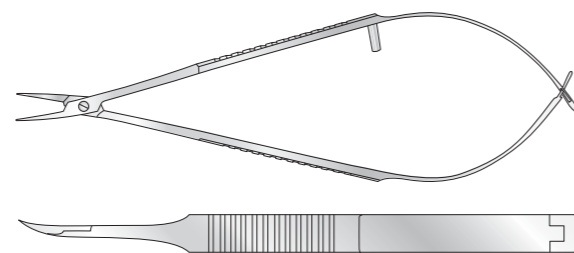

Code	Description
SC-OP/YA4010	110mm long

# Retractors, Speculums and Cannulas

## Lang Eyelid Retractor

76mm long

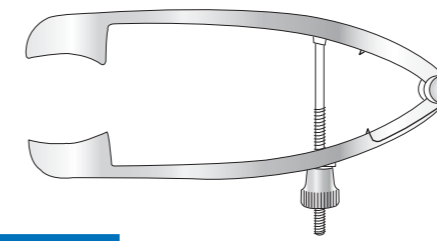

Code	Description
SC-OP/011b	Left eye
SC-OP/011c	Right eye

## Desmarre Eyelid Retractor

Single, 140mm long



Code	Description
SC-OP/013	12.7mm wide blade
SC-OP/014	15.9mm wide blade
SC-OP/015	19mm wide blade

## Barraquer Eye Speculum

Stainless steel wire, 44mm long

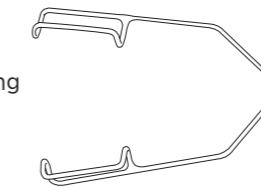

Code	Description
SC-OP/006	Standard
SC-OP/007	Small

## Speculum

Wire, 30mm wide x 45mm long

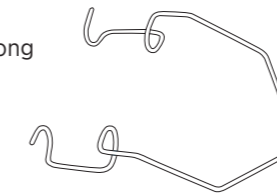

Code	Description
SC-OP/8004012	Titanium
SC-OP/8004012ss	Stainless

## Speculum

Wire, 25mm wide x 40mm long

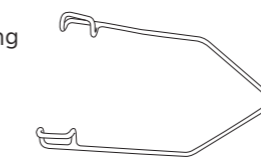

Code	Description
SC-OP/8004013	Titanium
SC-OP/8004013ss	Stainless

## Speculum

Wire, 20mm wide x 30mm long

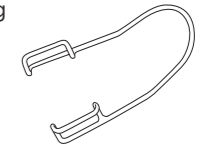

code	Description
SC-OP/8004013a	Titanium
SC-OP/8004013a-ss	Stainless

## Clark Speculum

Wire, 35mm wide x 84mm long

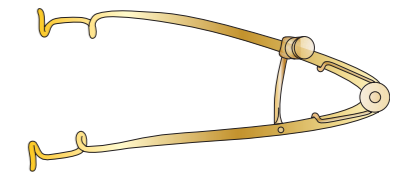

Code	Description
SC-SH/5746	
SC-SH/5746L	Infant - left
SC-SH/5746R	Infant - right

## Lang Lachrymal Cannula

38mm long



Code	Description
SC-OP/026	Cannula = 1mm ø

## Cannula

Curved, 44mm long



Code	Description
SC-OP/026	Flat ended

## Harrison Butler Lachrymal Cannula

38mm long



Code	Description
SC-OP/027	Cannula = 0.6mm ø

## Miscellaneous

### Spring Bag Clip

Serrated

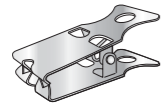

Code	Description
SC-GI/345	26mm wide

### Castroviejo Calliper

89mm long

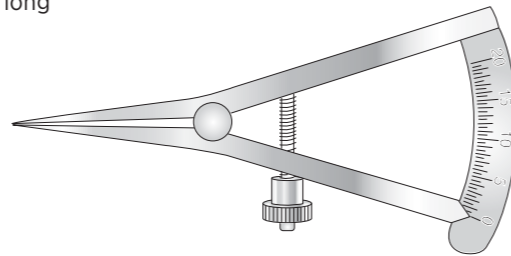

Code	Description
SC-OP/028	Stainless
SC-OP/8006007	Titanium

### Graefe Knife

127mm long

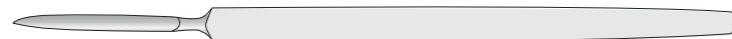

Code
SC-OP/010

### Tooke Knife

122mm long



Code	Description
SC-OP/035	6 sizes

### Chalazian Sharp Spoons

122mm long



Code	Description
SC-OP/034	6 sizes

### Snellen Vectis

Blunt, long loop, 140mm long



Code	Description
SC-OP/018	Straight
SC-OP/019	Angled

## Orthopaedic

Bone Cutting Forceps	140
Bone Rongeurs	141
Bone Holding Forceps	144
Bone Holding Clamps	146
Plaster Spreaders and Shears	147
Bone Curettes	148
Bone Levers	153
Retractors	154
Dissecting Forceps and Hooks	156
Raspatories, Burr and Rugines	157
Osteotomes, Chisels and Gouges	158
Wire Cutters and Pliers	161
Accessories	164
Mallets	165
Raspatories, Files and Punches	167
Pushers, Impactors and Skids	168
Elevators	169
Retractors and Bone Levers	172
Saws, Shears and Knives	173
Screw and Plate Instruments	173
Pins	174
Sterile Kirschner and Arthrodesis Wires	175
Extremities Instruments and Sets	176
Shoulder Instruments	178



# Bone Cutting Forceps

## McIndoe Bone Cutting Forcep

Lightweight, compound action, angled jaw with prismatic points

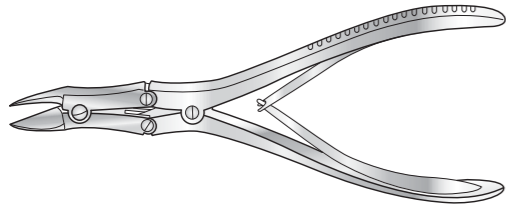

Code	Description
SC-OR/13b	165mm long
SC-OR/13c	191mm long

## Liston Screw Joint Bone Cutting Forcep

With fluted handle

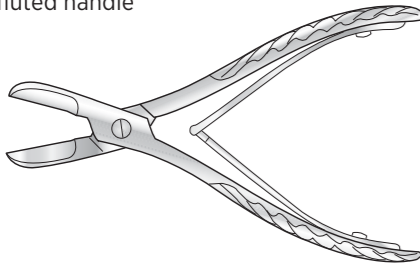

### 150mm long

Code	Description
SC-OR/24	Straight
SC-OR/24a	Angled

### 180mm long

Code	Description
SC-OR/25	Straight
SC-OR/25a	Angled

### 200mm long

Code	Description
SC-OR/26	Straight

### 230mm long

Code	Description
SC-OR/27	Straight

## Liston Compound Action Bone Cutting Forcep

Straight, for heavy duty

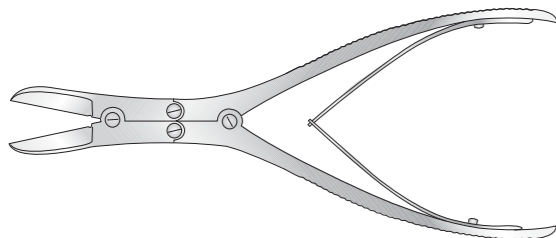

Code	Description
SC-OR/27a	305mm long
SC-OR/27b	300mm long
SC-OR/27c	190mm long

## Liston Box Joint Bone Cutting Forcep

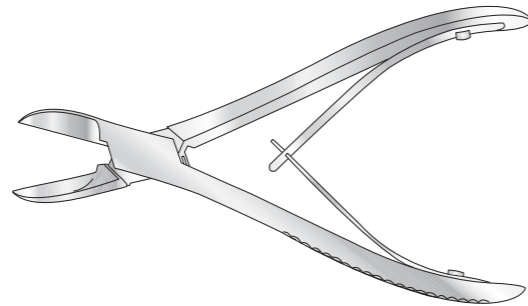

### Straight

Code	Description
SC-OR/032	140mm long
SC-OR/033	200mm long
SC-OR/027	220mm long

### Angled

Code	Description
SC-OR/061	170mm long
SC-OR/062	220mm long

## Screw Joint Bone Cutting Forcep

Straight

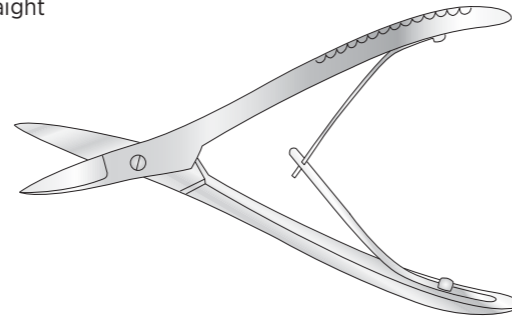

Code	Description
SC-OR/030	160mm long

## Ruskin-Liston Bone Cutting Forcep

Compound action, fine

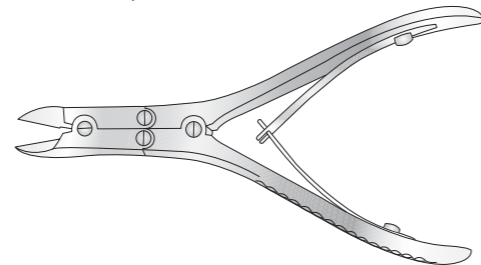

### Straight

Code	Description
SC-OR/057	140mm long
SC-OR/074	145mm long
SC-OR/073	190mm long

### Angled

Code	Description
SC-OR/063	190mm long

# Bone Cutting Forceps and Bone Rongeurs

## Ward Bone Cutting Forceps

Slightly angled on flat

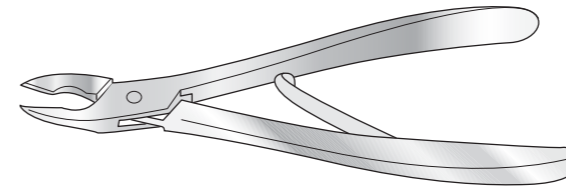

Code	Description
SC-GI/459	180mm long

## Horsley Compound Action Bone Cutter

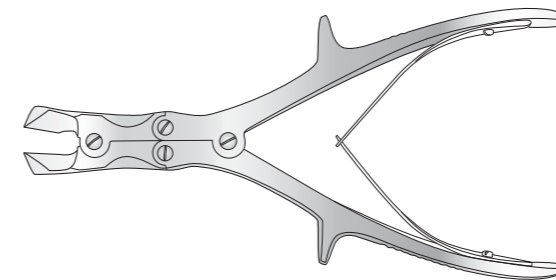

Code	Description
SC-OR/002	235mm long

## Stamms Box Joint Bone Cutter

Standard, stainless steel

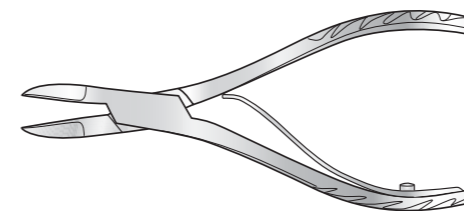

Code	Description
SC-OR/N056	140mm long

## Kleinert Kutz Bone Rongeur

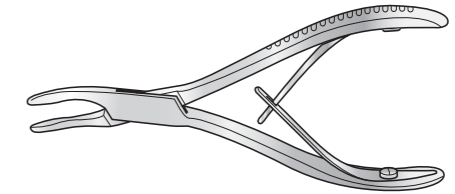

Code	Description
SC-OR/009a	Curved, 140mm, width 2mm
SC-OR/009	Curved, 155mm, width 2mm
SC-OR/011	Curved, 155mm, width 3mm

## Kleinert Kutz Skin Hooks



Code	Description
SC-PL/109	16cm large
SC-PL/108	16cm medium
SC-PL/107	16cm small

### Did you know...

**We repair power tools, pneumatic tools and hoses**



- ✓ Stryker, Synthes, Hall, Microaire, De Soutter, and all other common brands repaired
- ✓ All dental tools can be repaired, including bearings and rotor replacement
- ✓ We also repair Phaco Handpieces and Ultrasound Handpieces

[info@surgicalholdings.co.uk](mailto:info@surgicalholdings.co.uk)

# Bone Rongeurs

## Echlin Compound Action Bone Rongeur

Straight, with or without horn, 230mm long

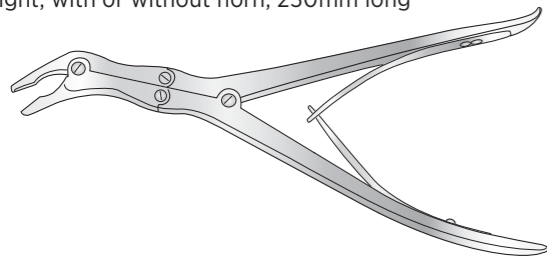

Code	Description
SC-OR/005	Width 2mm
SC-OR/006	Width 3mm
SC-OR/007	Width 4mm

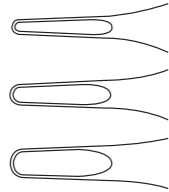

## Leksell Compound Action Bone Rongeur

250mm long

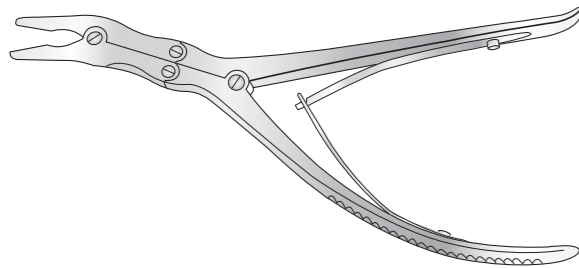

Code	Description
SC-OR/066	3mm bite
SC-OR/069	5mm bite
SC-OR/065	8mm bite

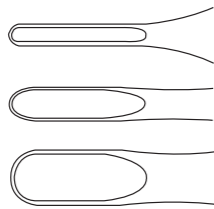

## Leksell Compound Action Bone Rongeur

240mm long

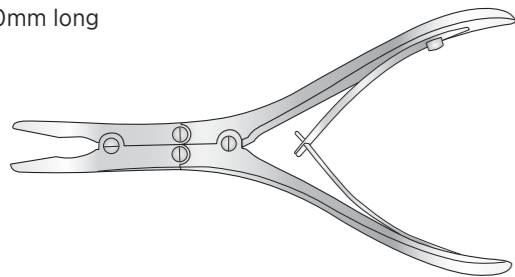

Code	Description
SC-OR/008	Width 3mm



## Stille Compound Action Bone Rongeur

Angled to side, 240mm long



Code	Description
SC-OR/037	11mm bite

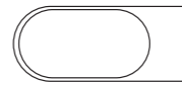

## Leksell Stille Compound Action Bone Rongeur

240mm long

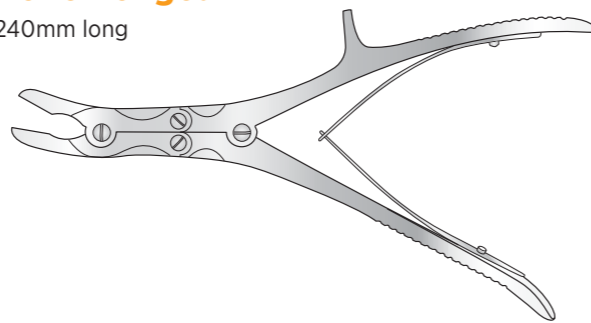

Code	Description
SC-OR/065a	8mm bite



## Luer Stille Compound Action Bone Rongeur

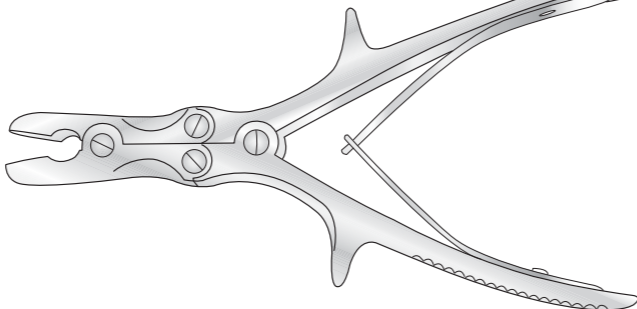

**Straight**

Code	Description
SC-OR/071	10mm bite, 220mm long
SC-OR/072	12mm bite, 260mm long

**Curved**

Code	Description
SC-OR/071a	10mm bite, 220mm long
SC-OR/071b	11mm bite, 230mm long

## Luer Compound Action Bone Rongeur

6mm bite, 190mm long

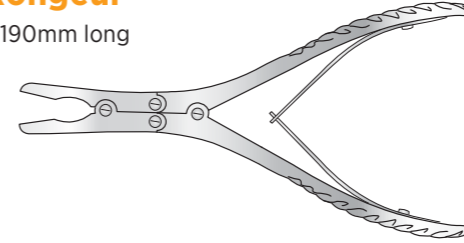

Code	Description
SC-OR/13	Straight
SC-OR/13a	Curved

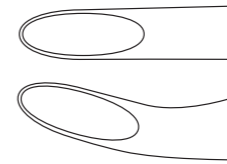

## Luer Box Joint Bone Rongeur

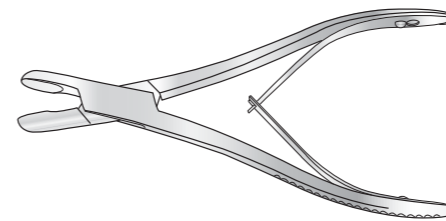

**Straight, 185mm long**

Code	Description
SC-OR/031	8mm bite
SC-OR/041	10mm bite

**Curved, 210mm long**

Code	Description
SC-OR/042	8mm bite

## Cushing Screw Joint Bone Rongeur

190mm long

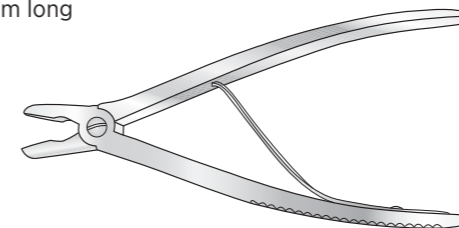

**Straight**

Code	Description
SC-OR/039	4mm bite
SC-OR/058	6mm bite
SC-OR/059	8mm bite

**Curved**

Code	Description
SC-OR/060	4mm bite
SC-OR/067	6mm bite
SC-OR/068	8mm bite

## Ruskin Compound Action Bone Rongeur

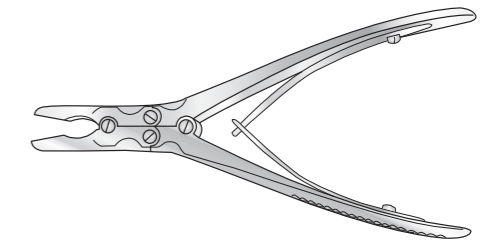

**3mm bite, 150mm long**

Code	Description
SC-OR/034	Straight
SC-OR/035	Curved

**4mm bite, 185mm long**

Code	Description
SC-OR/028	Straight
SC-OR/036	Curved

## Compound Action Bone Rongeur

Lightweight pattern, curved, 150mm long

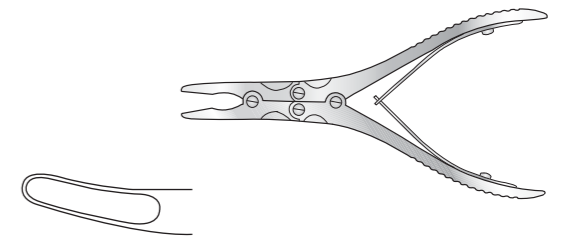

Code	Description
SC-OR/013d	4mm bite

## Lempert Box Joint Bone Rongeur

3mm bite, 155mm long

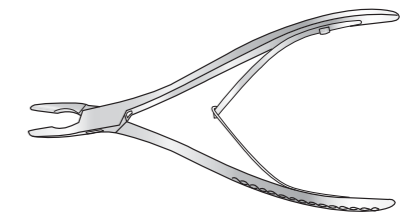

Code	Description
SC-OR/327	Straight
SC-OR/010	Curved

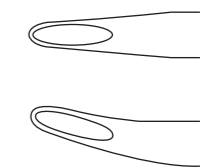



# Bone Holding Forceps

## Lambotte Bone Holding Forceps

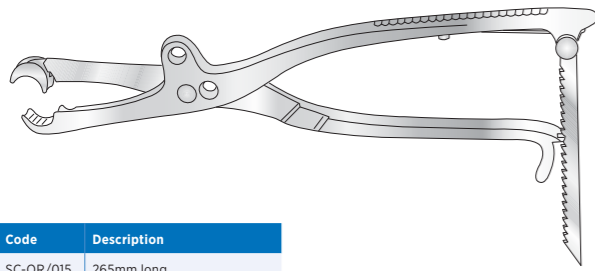

Code	Description
SC-OR/015	265mm long

## Lambotte Bone Holding Forceps

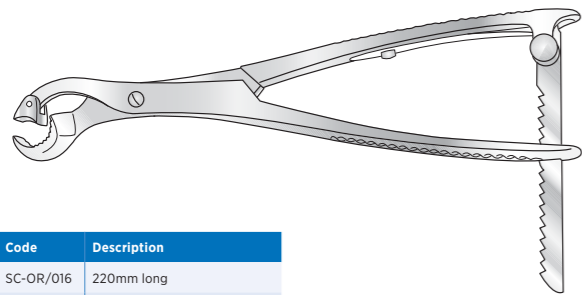

Code	Description
SC-OR/016	220mm long
SC-OR/017	215mm long
SC-OR/022	330mm long

## Farabeuf Bone Holding Forceps

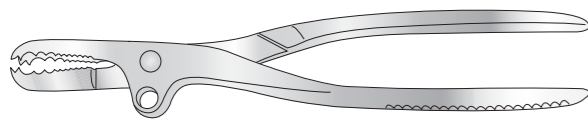

Code	Description
SC-OR/021	230mm long
SC-OR/328	250mm long

## Farabeuf-Lambotte Bone Holding Forceps

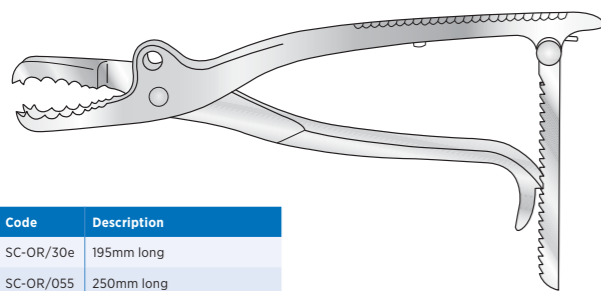

Code	Description
SC-OR/30e	195mm long
SC-OR/055	250mm long
SC-OR/30f	260mm long

## Bone Holding Forceps

Screw joint, with holding screw

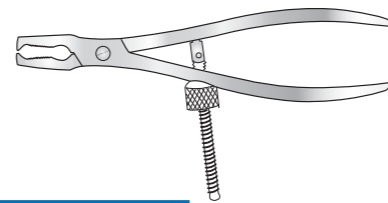

Code	Description
SC-OR/029	165mm long

## Hey Groves Bone Holding Forceps

With screw locking device



Code	Description
SC-OR/29d	200mm long
SC-OR/29e	225mm long
SC-OR/29f	305mm long

## Bone Holding Forceps

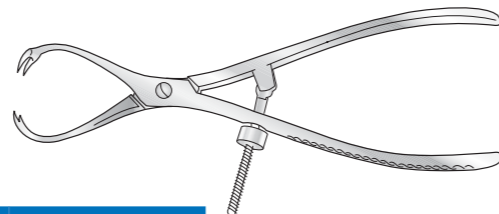

Code	Description
SC-OR/13	140mm long
SC-OR/014	185mm long
SC-OR/018	215mm long
SC-OR/019	275mm long

## Fergusson Bone Holding Forceps

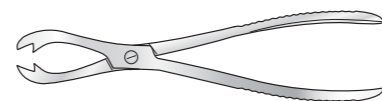

Code	Description
SC-OR/30	150mm long
SC-OR/30a	200mm long
SC-OR/30b	230mm long

## Frosch Bone Holding Forceps

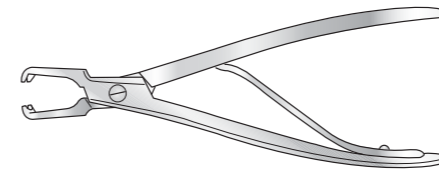

Code	Description
SC-OR/N061	180mm long

## Joint Calcaneal Spreader

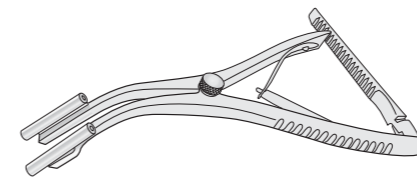

Code	Description
SC-OR/CAL001	40mm opening, 1.6mm ø, 170mm long

## Inge Type Lamina Spreader

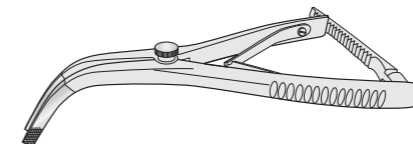

Code	Description
SC-OR/CAL003	40mm opening, no teeth, 5mm wide tip, 170mm long

## Harrison Bone Holding Forceps

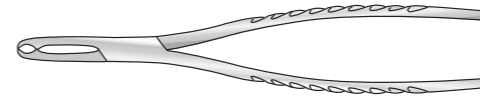

Code	Description
SC-OR/30d	190mm long

# Bone Holding Forceps

## Sequestrum (Necrosis) Forcep

Straight, long fine jaws

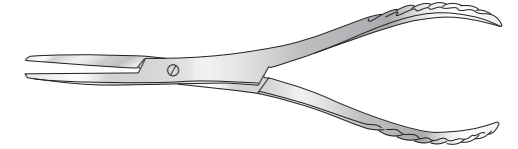

Code	Description
SC-OR/SEQ001	191mm long
SC-OR/SEQ002	203mm long

## Calcaneal Spreader

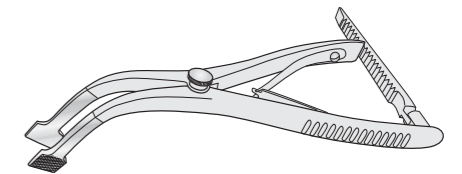

Code	Description
SC-OR/CAL002	40mm opening, 15mm wide tip, 70mm long

## Inge Type Lamina Spreader

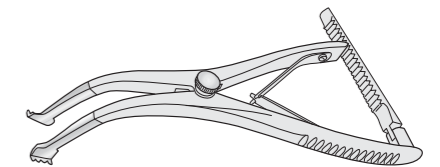

Code	Description
SC-OR/CAL004	Baby, 40mm opening, with teeth, 10mm wide tip, 160mm long
SC-OR/CAL004a	50mm opening, with teeth, 10mm wide tip, 240mm long

## St Thomas Bone Holding Forceps

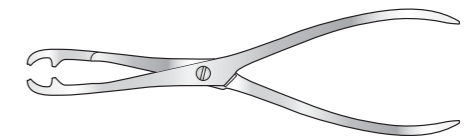

Code	Description
SC-OR/403c	182mm long

# Bone Holding Forceps and Clamps

## Burns Bone Holding Forceps

Box joint

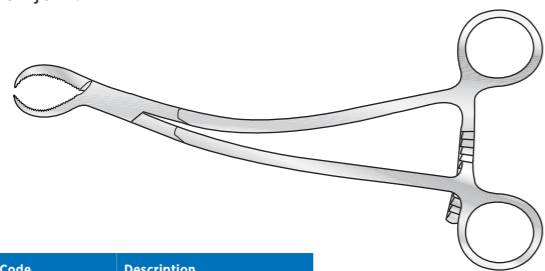

Code	Description
SC-OR/29a	200mm long

## Scarf Type Clamp

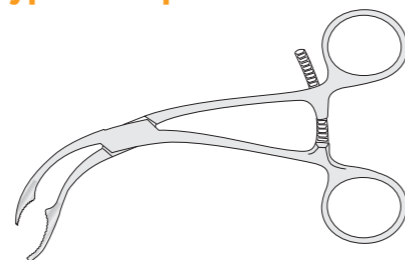

Code	Description
SC-OR/SCA	150mm long

## Orthopaedic Grasping Forceps

Box joint

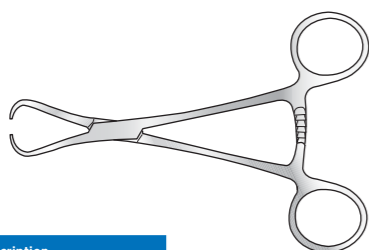

Code	Description
SC-OR/29b	125mm long
SC-OR/29c	165mm long

## Lowman Bone Holding Clamp

Infant 125mm long  
Child 175mm long  
Adult 205mm long

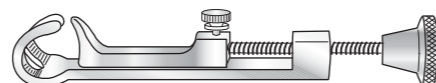

Code	Description
SC-OR/28	

## Reduction Forcep

With adjustable lock

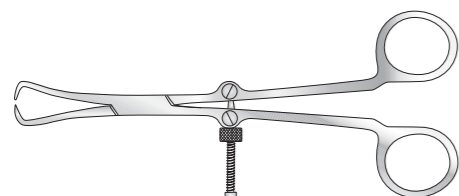

Code	Description
SC-OR/RED001a	Small, 135mm long
SC-OR/RED001b	Large, 168mm long

## Parker Modified Lowman Bone Holding Clamp, Single

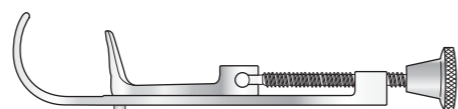

Code	Description
SC-OR/5644	160mm long

## Verbrugge Bone Holding Forceps



Code	Description
SC-OR/30c	180mm long

## Parker Retractor

For use with Lowman clamp

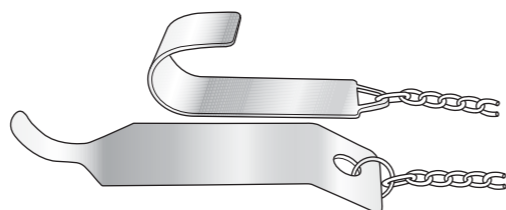

Code	Description
SC-OR/5643	Chain 850mm long

# Plaster Spreaders and Shears

## Haglund Plaster Spreader

Working part curved in right

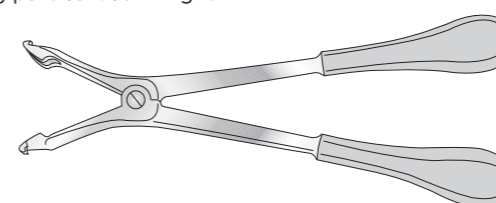

Code	Description
SC-OR/207	280mm long

## Plaster Cutter

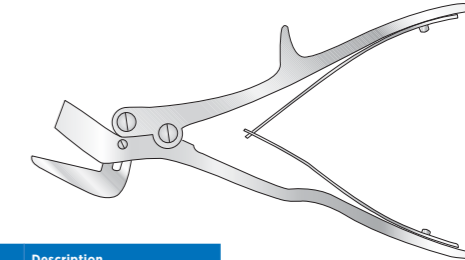

Code	Description
SC-OR/40	240mm long

## Lawton Plaster Spreader

Working part curved in right

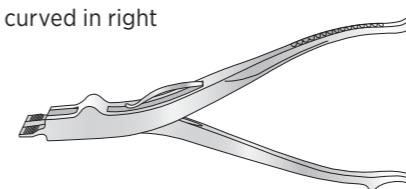

Code	Description
SC-OR/208	220mm long

## Bohler Plaster Shears

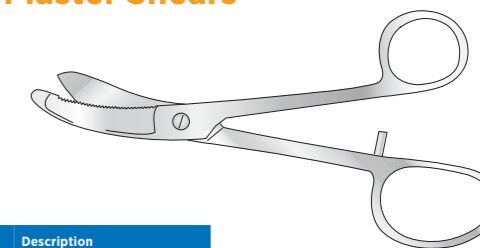

Code	Description
SC-OR/38	240mm long

## Henning Plaster Spreader

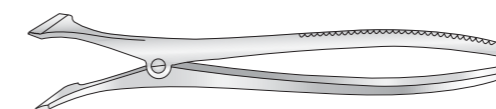

Code	Description
SC-OR/211	270mm long

## Guys Plaster Shears



Code	Description
SC-OR/39	240mm long

## Wolf Plaster Spreader



Code	Description
SC-OR/212	180mm long
SC-OR/329	250mm long

## Engel Plaster Saw

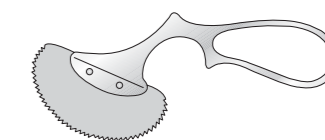

Code	Description
SC-OR/40b	150mm long

## Stille Type Plaster Shears

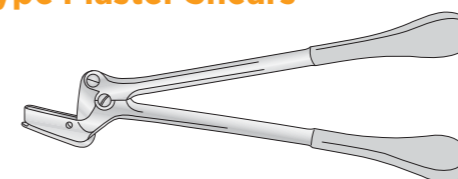

Code	Description
SC-OR/210	380mm long
SC-OR/210a	330mm long
SC-OR/210b	460mm long

## Eccentric Plaster Shears

Without heavy serrated blade

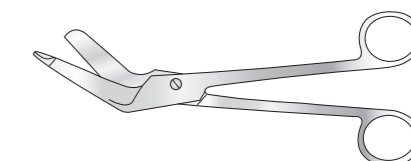

Code	Description
SC-OR/40a	190mm long

# Bone Curettes

## Bone Curette

Straight, 180mm long

Code	Description	Code	Description
SC-OR/075	Width 2mm	SC-OR/079	Width 10mm
SC-OR/076	Width 4mm	SC-OR/080	Width 12mm
SC-OR/077	Width 6mm	SC-OR/081	Width 14mm
SC-OR/078	Width 8mm	SC-OR/082	Width 16mm

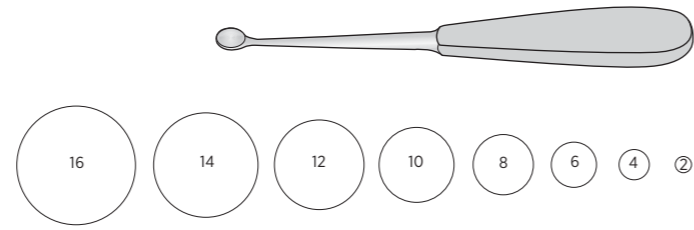

## Bone Curette

Straight, 260mm long

Code	Description	Code	Description
SC-OR/083	Width 2mm	SC-OR/086	Width 8mm
SC-OR/084	Width 4mm	SC-OR/087	Width 10mm
SC-OR/085	Width 6mm	SC-OR/088	Width 12mm

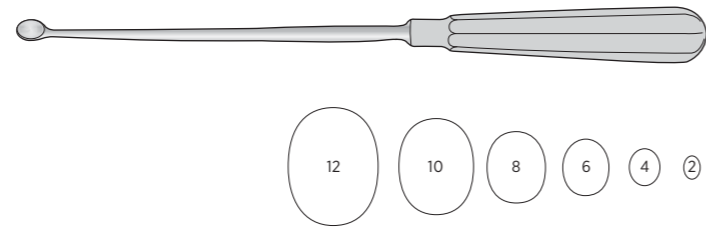

## Bone Curette

Straight, 210mm long

Code	Description
SC-OR/089	Width 2mm
SC-OR/090	Width 4mm
SC-OR/091	Width 6mm
SC-OR/092	Width 8mm
SC-OR/093	Width 10mm
SC-OR/094	Width 12mm
SC-OR/095	Width 14mm
SC-OR/096	Width 16mm
SC-OR/097	Width 20mm

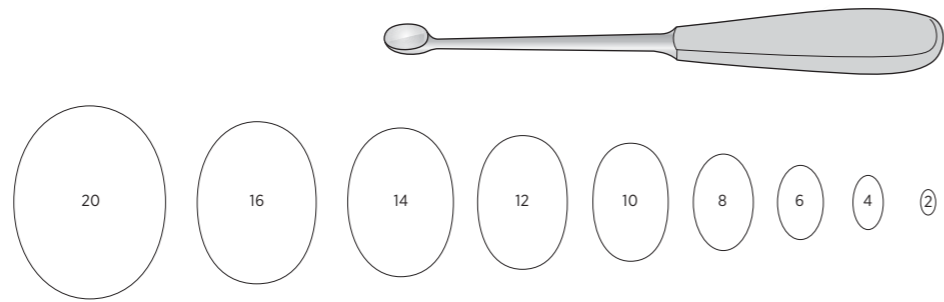

## Busche Bone Curette

Angled, 250mm long

Code	Description
SC-OR/138	Width 3mm
SC-OR/139	Width 4mm
SC-OR/140	Width 5mm

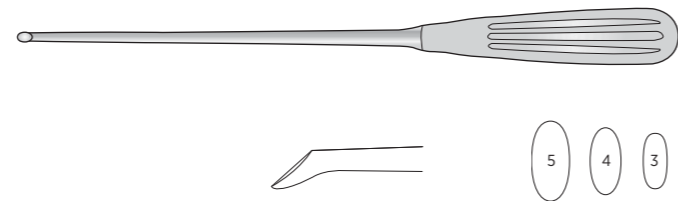

## Bruns Bone Curette

225mm long

Straight		Angled	
Code	Description	Code	Description
SC-OR/189	Width 3mm	SC-OR/195	Width 3mm
SC-OR/190	Width 4mm	SC-OR/196	Width 4mm
SC-OR/191	Width 5mm	SC-OR/197	Width 5mm
SC-OR/192	Width 6mm	SC-OR/198	Width 6mm
SC-OR/193	Width 7mm	SC-OR/199	Width 7mm
SC-OR/194	Width 8mm	SC-OR/200	Width 8mm

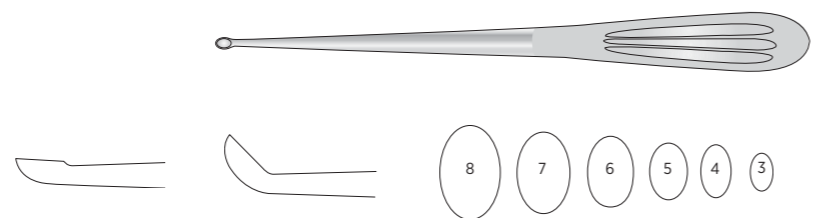

# Bone Curettes

## Gourdet Bone Curette

Straight, blunt  
280mm long

Code	Description
SC-OR/157	Width 6mm
SC-OR/158	Width 8mm
SC-OR/159	Width 10mm
SC-OR/160	Width 12mm
SC-OR/161	Width 14mm

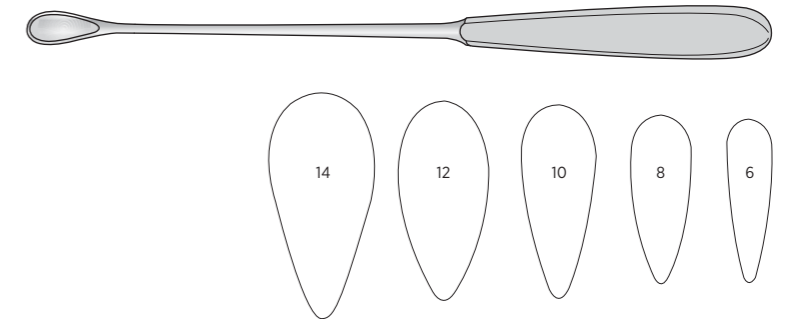

## Shroeder Bone Curette

Straight, 310mm long

Code	Description
SC-OR/151	Width 6mm
SC-OR/152	Width 8mm
SC-OR/153	Width 10mm
SC-OR/154	Width 12mm
SC-OR/155	Width 14mm

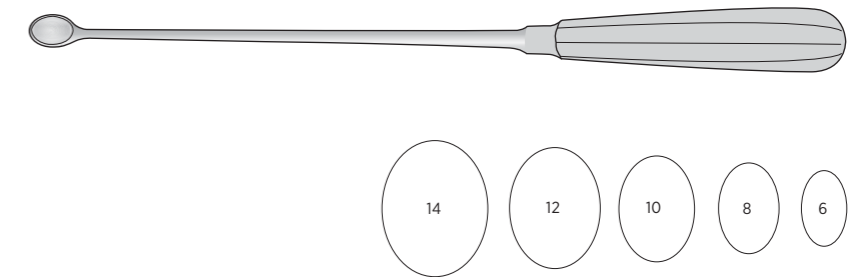

## Simon Bone Curette

Straight, 240mm long

Code	Description
SC-OR/145	Width 6mm
SC-OR/146	Width 8mm
SC-OR/147	Width 10mm
SC-OR/148	Width 12mm
SC-OR/149	Width 14mm

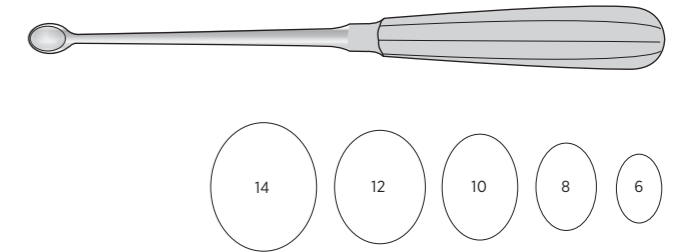

## Spinal Curette

Oval, 205mm long

Code	Description	Code	Description
SC-OR/031a	Width 4mm	SC-OR/031e	Width 8mm
SC-OR/031b	Width 5mm	SC-OR/031f	Width 9mm
SC-OR/031c	Width 6mm	SC-OR/031g	Width 10mm
SC-OR/031d	Width 7mm	SC-OR/031h	Width 11mm

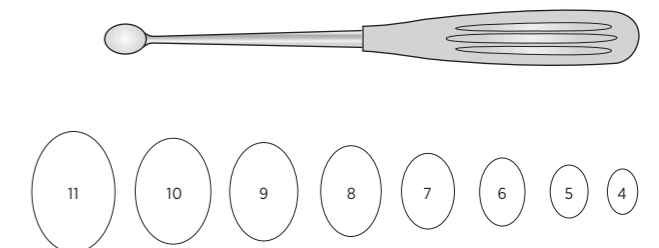

# Bone Curettes

## Volkman Bone Curette

Straight, 170mm long

Code	Description	Code	Description
SC-OR/112	Width 2mm	SC-OR/117	Width 8mm
SC-OR/113	Width 3mm	SC-OR/118	Width 10mm
SC-OR/114	Width 4mm	SC-OR/119	Width 12mm
SC-OR/115	Width 5mm	SC-OR/120	Width 14mm
SC-OR/116	Width 6mm		

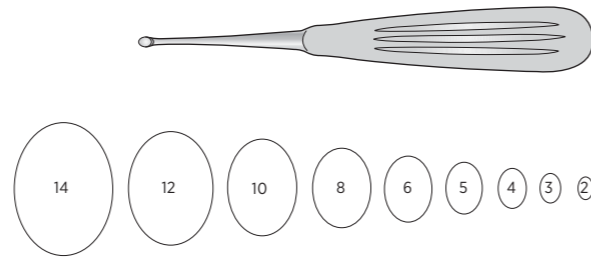

## Volkman Bone Curette

Straight, 230mm long

Code	Description
SC-OR/SH.5687	Bowl width 10mm, bowl length 14.5mm



## Wallich Bone Curette

Blunt

Code	Description
SC-OR/162	420mm long

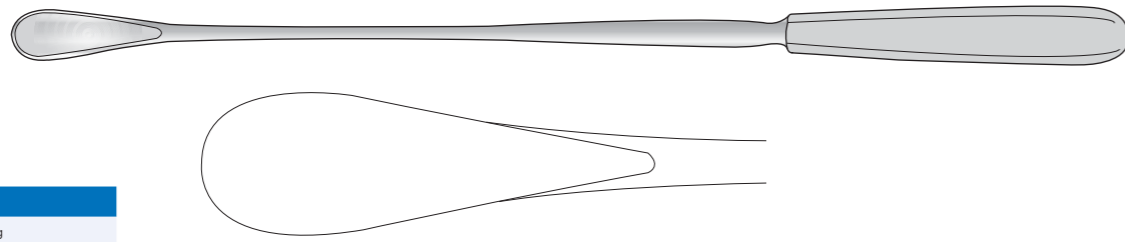

## Williger Bone Curette

Straight, 170mm long

Code	Description
SC-OR/122	Width 3.5mm
SC-OR/123	Width 5.5mm

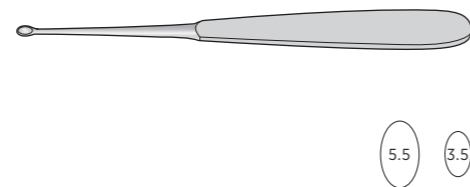

## Charnley Bone Curette

With T handle, 380mm long

Code	Description
SC-OR/N040	Large, 20 x 14mm
SC-OR/N041	Medium, 17 x 12mm
SC-OR/N042	Small, 11 x 8mm

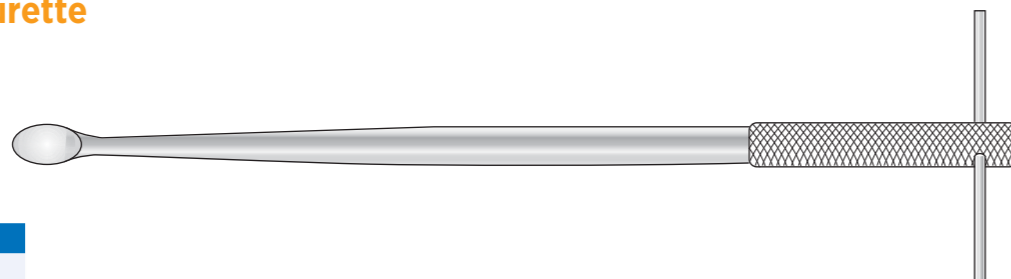

# Bone Curettes

## Sypert Bone Curette

Blue acetal "Suregrip" handle, 380mm long

### Straight

Code	Description
SC-OR/236	Width 3mm
SC-OR/237	Width 4mm
SC-OR/238	Width 5mm

### Angled

Code	Description
SC-OR/240	Width 3mm
SC-OR/241	Width 4mm
SC-OR/245	Width 5mm

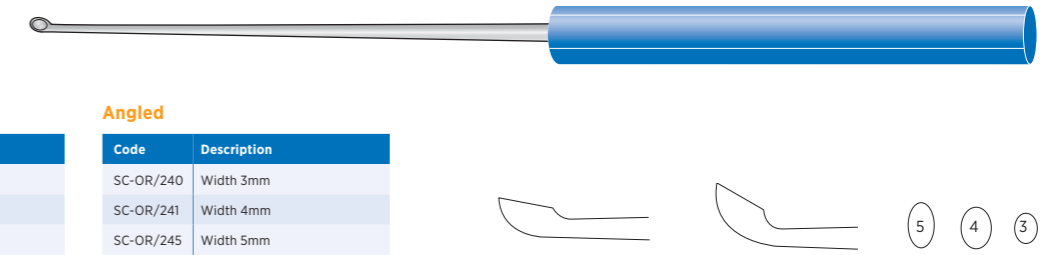

## Bone Curette

Blue acetal "Suregrip" handle, 410mm long

### Straight

Code	Description
SC-OR/249	Width 3mm
SC-OR/250	Width 4mm
SC-OR/251	Width 5mm

### Angled

Code	Description
SC-OR/252	Width 3mm
SC-OR/253	Width 4mm
SC-OR/254	Width 5mm

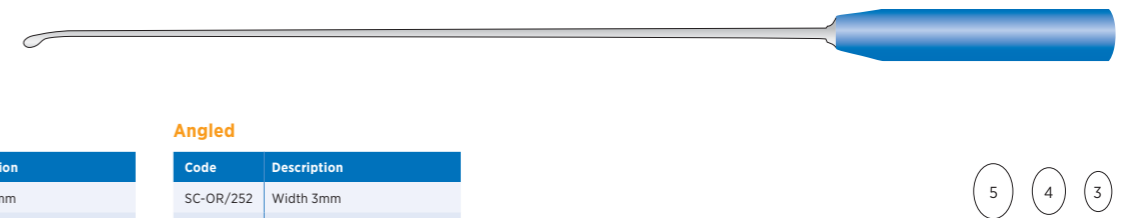

## Caspar Bone Curette

Blue acetal "Suregrip" handle, 220mm long

### Straight

Code	Description
SC-OR/230	Width 3.5mm
SC-OR/231	Width 4.5mm
SC-OR/232	width 5.5mm

### Angled

Code	Description
SC-OR/233	Width 3.5mm
SC-OR/234	Width 4.5mm
SC-OR/235	Width 5.5mm

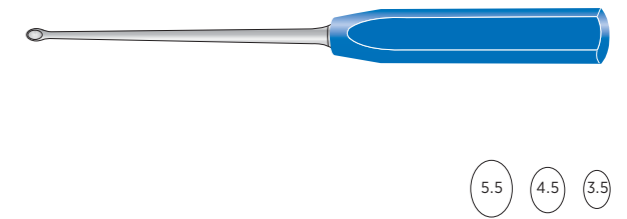

## Bone Curette

Blue acetal "Suregrip" handle, 270mm long, straight

Code	Description
SC-OR/226	Width 4mm
SC-OR/227	Width 6mm
SC-OR/228	Width 8mm
SC-OR/229	Width 10mm

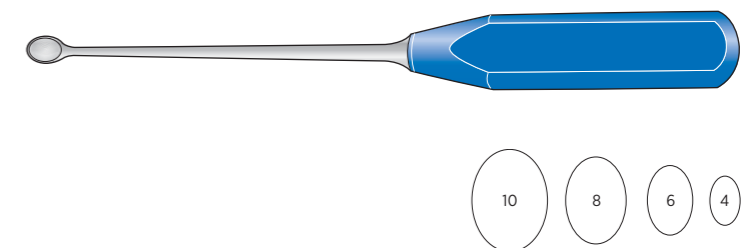

# Bone Curettes

## Capener Spoon

Blue acetal "Suregrip" handle 285mm long

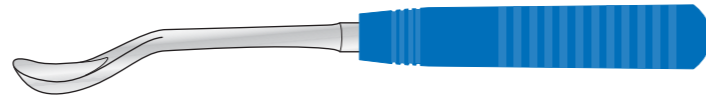

Code	Description
SC-OR/389a	Width 16mm
SC-OR/389b	Width 20mm

## Capener Lamina Curette

Blue acetal "Suregrip" handle 300mm long



Code	Description
SC-OR/389c	12 x 32mm
SC-OR/389d	6 x 18mm

## Stanley Boyd Curette

Double ended

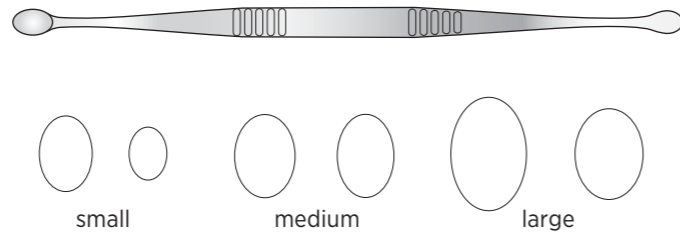

Code	Description
SC-OR/162a	Small - 50mm long
SC-OR/162b	Medium - 200mm long
SC-OR/162c	Large - 250mm long

## Volkman Bone Scoop

Double-ended, straight



Code	Description
SC-OR/31	175mm long
SC-OR/213	220mm long
SC-OR/175	220mm long

## Martini Bone Curette

Shown at half size  
double-ended, straight 140mm long



Code	Description
SC-OR/170	Small and medium
SC-OR/171	Medium and large

# Bone Levers

## Lane Bone Lever

240mm long

6mm

Code	Description
SC-OR/N011	Slight curve
SC-OR/N012	Full curve

8mm

Code	Description
SC-OR/N013	Slight curve
SC-OR/N014	Full curve



## Lane Bone Lever

For small bones



Code	Description
SC-OR/N015	10mm wide, 265mm long

## Lane Bone Lever

For small bones, serrated end

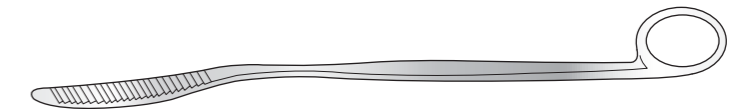

Code	Description
SC-OR/N016	10mm wide, 260mm long

## Trethowan Bone Lever

Ring handle



Code	Description
SC-OR/N017	220mm long

## Watson-Jones Bone Lever

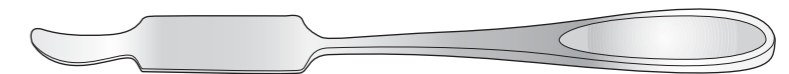

Code	Description
SC-OR/N054	275mm long

## Bankhart Bone Lever



Code	Description
SC-OR/SH.5315	300mm long

# Retractors

## Hip Set

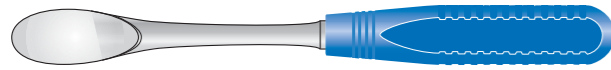

**Femoral Dislocation Lever 285mm**

Code	Description
SC-OR/N059A	Spoon elevator 25mm with blue acetal suregrip handle - large

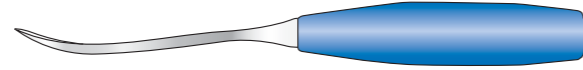

**Curved Osteotome 260mm**

Code	Description
SC-OR/N059D	With blue acetal suregrip handle - 2

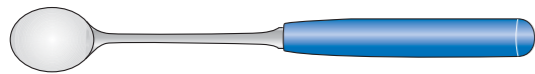

**Muller Curette 240mm**

Code	Description
SC-OR/N059B	Curette 27mm with blue acetal suregrip handle - large



**Small Gouge 240mm**

Code	Description
SC-OR/N059E	8mm cranked blue acetal suregrip handle



**Muller Curette 270mm**

Code	Description
SC-OR/N059C	Curette 9mm with blue acetal suregrip handle - small

## Charnley Initial Incision Retractor

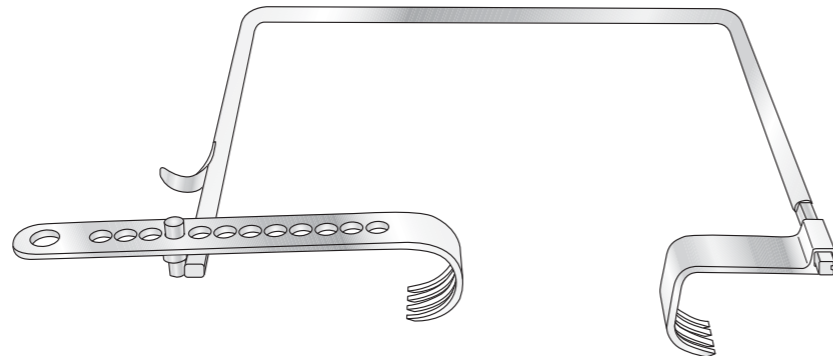

Code	Description
SC-OR/N038a	Frame only
SC-OR/N038b	Weight only, 75mm x 50mm ø
SC-OR/N038s	Goal post pins and chain

### Short blades

Code	Description
SC-OR/N038r	Short blade, 25mm deep
SH006084	Short blade, 35mm deep
SC-OR/N038c	Short blade, 50mm deep
SC-OR/N038l	Short blade, 65mm
SC-OR/N038e	Short blade, 75mm deep
SC-OR/N038q	Short blade, 80mm deep
SC-OR/N038g	Short blade, 100mm deep
SH003879	Short blade, 125mm
SH003880	Short blade, 150mm

### Long blades

Code	Description
SH006085	Long blade, 35mm deep
SC-OR/N038d	Long blade, 50mm deep
SC-OR/N038k	Long blade, 65mm
SC-OR/N038p	Long blade, 70mm deep
SC-OR/N038f	Long blade, 75mm deep
SC-OR/N038h	Long blade, 100mm deep
SH003877	Long blade, 125mm
SH003878	Long blade, 150mm
SC-OR/N038m	Long round blade, 50mm deep

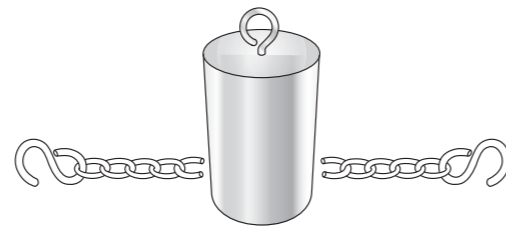

# Retractors

## Travers Retractor

Self retaining, internal rack, 210mm long

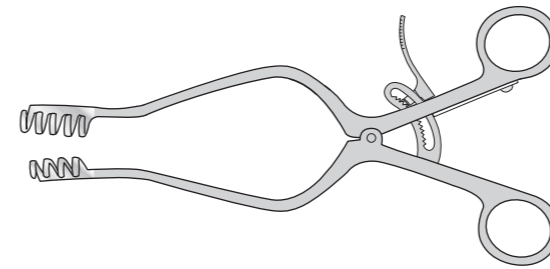

Code	Description
SC-GI/323	4 x 5 teeth, 95mm fully open

## Jackson Burrows Retractor

Self retaining

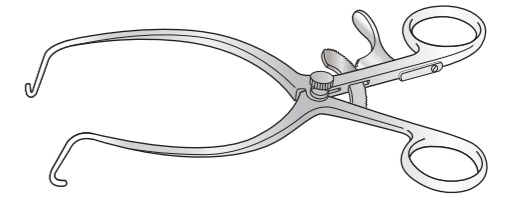

Code	Description
SC-GI/377	175mm

## West Retractor

Self retaining, 140mm long

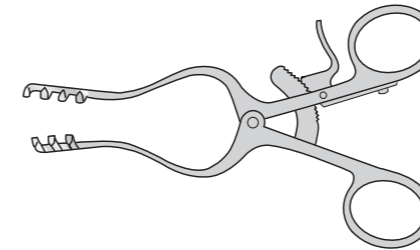

Code	Description
SC-GI/326	3 x 4 teeth, 60mm fully open
SC-GI/326cr	3 x 4 teeth, 60mm fully open, with cam rack

## Norfolk and Norwich Retractor

4 x 5 teeth 50mm blades x 223mm long

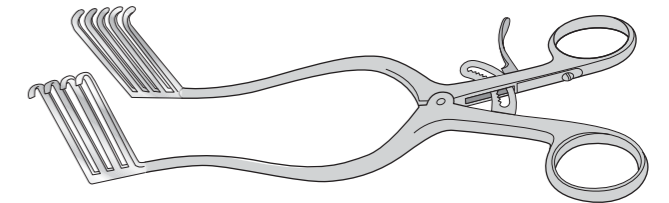

Code	Description
SC-GI/325	Standard rack

## Refurbishment of orthopaedic sets

Refurbishing instruments can save up to **80%** of the cost of buying new, with compelling evidence to demonstrate effectiveness

Independent research<sup>1</sup> showed that instruments refurbished by Surgical Holdings had a 4x reduction in the amount of residual protein.

The smooth and polished surface has an increased cleaning efficacy, and all refurbishments come with an 18 month warranty as standard. Standard turnaround times are 1 week and an express 2 day service is also available.

Reference: <sup>1</sup>Data available on file.

Book your orthopaedic set refurbishment on [info@surgicalholdings.co.uk](mailto:info@surgicalholdings.co.uk)



Before Refurbishment      After Refurbishment

# Retractors, Dissecting Forceps and Hooks

## Jackson Burrows Hand Retractor

225mm long

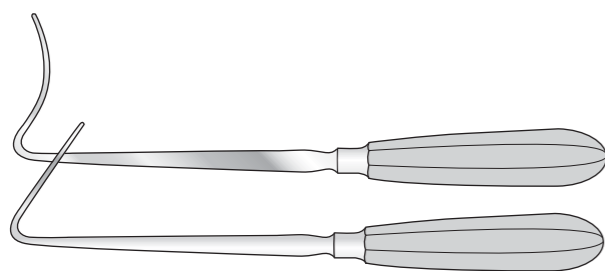

Code	Description
SC-OR/N050	Narrow curve, 13mm blade
SC-OR/N050a	Broad, angular, 20mm blade

## Ballance (Volkman) Retractor

203mm long

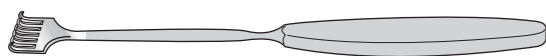

### Sharp

Code	Description
SC-GI/463	1 prong
SC-GI/463a	2 prong
SC-GI/463b	3 prong
SC-GI/463c	4 prong
SC-GI/463d	6 prong

### Blunt

Code	Description
SC-GI/463e	1 prong
SC-GI/463f	2 prong
SC-GI/463g	3 prong
SC-GI/463h	4 prong
SC-GI/463i	6 prong

## Jackson Burrows Dissecting Forcep

140mm long

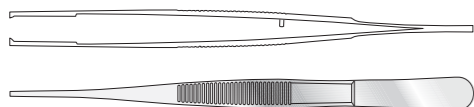

Code	Description
SC-OR/N037	Tongue and groove only
SC-OR/N037a	Tongue and groove, 1-2 teeth

## Charnley-McIndoe Dissecting Forceps

150mm long

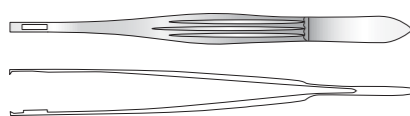

Code	Description
SC-OR/N045a	2-3 teeth

## Kocher Bone Hook

220mm long



Code	Description
SC-OR/N036	Sharp
SC-OR/N036a	Blunt

## Langenbeck Bone Hook

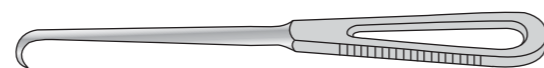

Code	Description
SC-OR/391	200mm long

## Dislocation Hook

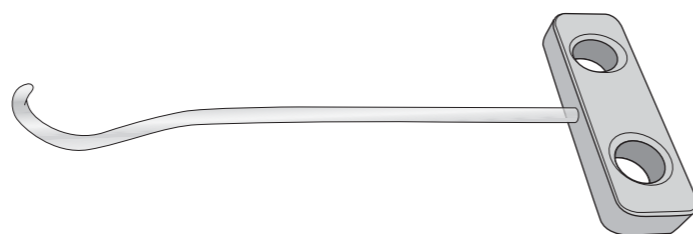

Code	Description
SC-OR/SH-5703	253mm long

## Dislocation Hip Hook

Blue acetal "Suregrip" handle

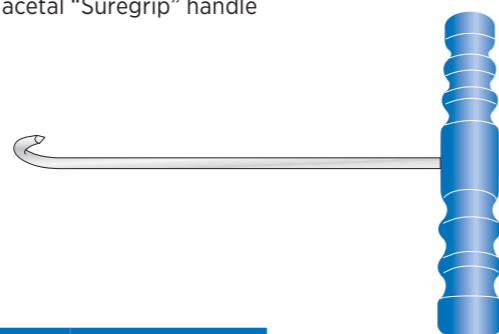

Code	Description
SC-OR/420	185mm long

# Raspatories, Burr and Rugines

## Key Raspatories



Code	Description
SC-OR/310	Width 6.4mm 180mm long
SC-OR/313	Width 9.5mm 190mm long
SC-OR/311	Width 12.7mm 190mm long
SC-OR/312	Width 19mm 200mm long
SC-OR/314	Width 25.4mm 210mm long

## Lambotte Raspatory

205mm Long

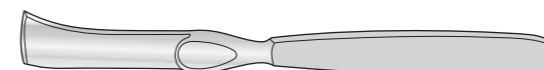

Code	Description
SC-OR/242	Width 10mm
SC-OR/243	Width 15mm
SC-OR/244	Width 20mm

## Paton Bone Burr

Satin handle, 155mm long

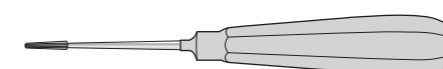

Code	Description
SC-OR/403	3.5mm ø x 17mm
SC-OR/403a	4.5mm ø x 17mm
SC-OR/403b	5.0mm ø x 17mm

## Robert Jones Rugine

Convex sharp edge, fan shaped end, with solid pistol handle

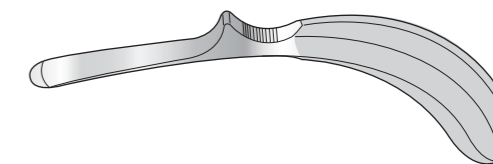

Code	Description
SC-OR/N035	185mm long

## Mitchell Rugine

Straight, sharp edge, fan shaped, hollow handle

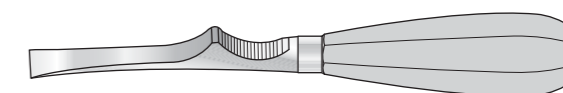

Code	Description
SC-OR/N034	210mm long

## Farabeuf Rugine

Curved end, chisel edge, hollow handle

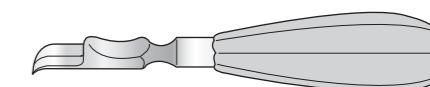

Code	Description
SC-OR/N033	160mm long

# Osteotomes, Chisels and Gouges

## Lexer Osteotome

Blue acetal "Suregrip" handle, 180mm long



Code	Description
SC-OR/SH5347a	4mm

## Capener Osteotome

Blue acetal "Suregrip" handle, 250mm long

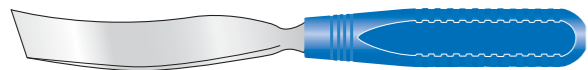

### Shallow curved

Code	Description
SC-OR/384	Width 6mm
SC-OR/385	Width 10mm
SC-OR/386	Width 12mm
SC-OR/387	Width 15mm
SC-OR/388	Width 20mm
SC-OR/389	Width 25mm
SC-OR/390	Width 30mm

### Acute curved

Code	Description
SC-OR/390a	Width 6mm
SC-OR/390b	Width 10mm
SC-OR/390c	Width 15mm
SC-OR/390d	Width 20mm
SC-OR/390e	Width 25mm

## Capener Osteotome

Blue acetal "Suregrip" handle, straight, 255mm long

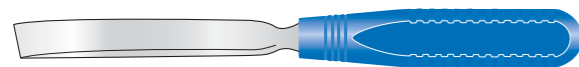

Code	Description	Code	Description
SC-OR/374	Width 6mm	SC-OR/379	Width 15mm
SC-OR/375	Width 8mm	SC-OR/380	Width 18mm
SC-OR/376	Width 10mm	SC-OR/381	Width 20mm
SC-OR/377	Width 12mm	SC-OR/382	Width 25mm
SC-OR/378	Width 13mm	SC-OR/383	Width 30mm

## Capener Chisel

Blue acetal "Suregrip" handle straight, 250mm long

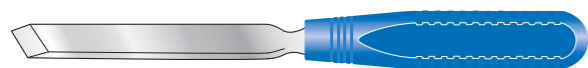

Code	Description	Code	Description
SC-OR/368	Width 6mm	SC-OR/371	Width 15mm
SC-OR/369	Width 10mm	SC-OR/372	Width 20mm
SC-OR/370	Width 12mm	SC-OR/373	Width 25mm

## Capener Lamina Gouge

Blue acetal "Suregrip" handle, straight, 265mm long



Code	Description	Code	Description
SC-OR/362	Width 6mm	SC-OR/365	Width 15mm
SC-OR/363	Width 10mm	SC-OR/366	Width 20mm
SC-OR/364	Width 12mm	SC-OR/367	Width 25mm

## Capener Lamina Gouge

Cranked, blue acetal "Suregrip" handle, 250mm long

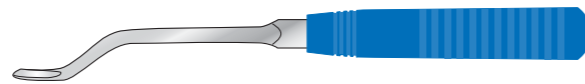

Code	Description	Code	Description
SC-OR/373c	Width 6mm	SC-OR/373cre	Width 6mm
SC-OR/373d	Width 8mm	SC-OR/373dre	Width 8mm
SC-OR/373j	Width 10mm	SC-OR/373jre	Width 10mm
SC-OR/373e	Width 11mm	SC-OR/373ere	Width 11mm
SC-OR/373f	Width 16mm	SC-OR/373fre	Width 16mm
SC-OR/373k	Width 17mm	SC-OR/373kre	Width 17mm

### With reversed edge

OTHER LENGTHS AND SIZES AVAILABLE

## Capener Lamina Gouge

Swan neck, blue acetal "Suregrip" handle, 250mm long

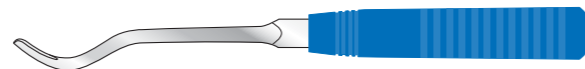

Code	Description
SC-OR/373g	Width 8mm

## Capener Lamina Gouge

Reverse cranked, blue acetal "Suregrip" handle, 245mm long

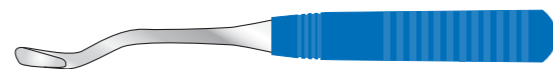

Code	Description	Code	Description
SC-OR/373ar	Width 11mm	SC-OR/373Or	Width 6mm
SC-OR/373nr	Width 16mm	SC-OR/373lr	Width 8mm
SC-OR/373jr	Width 17mm	SC-OR/373mr	Width 10mm

# Osteotomes, Chisels and Gouges

## Read Osteotome

Serrated head  
180mm long



Code	Description
SC-OR/335	Width 4mm
SC-OR/336	Width 5mm

## Read Gouge

Serrated head, 180mm long



Code	Description	Code	Description
SC-OR/344	Width 2mm	SC-OR/341	Width 6mm
SC-OR/345	Width 3mm	SC-OR/342	Width 7mm
SC-OR/346	Width 4mm	SC-OR/343	Width 8mm
SC-OR/347	Width 5mm		

## Read Chisel

Serrated head, 180mm long



Code	Description	Code	Description
SC-OR/337	Width 2mm	SC-OR/341	Width 6mm
SC-OR/338	Width 3mm	SC-OR/342	Width 7mm
SC-OR/339	Width 4mm	SC-OR/343	Width 8mm
SC-OR/340	Width 5mm		

## Swedish Pattern Osteotome

200mm long

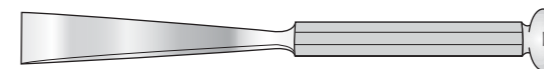

Code	Description	Code	Description
SC-OR/348	Width 10mm	SC-OR/348tc	Width 10mm
SC-OR/349	Width 15mm	SC-OR/349tc	Width 15mm
SC-OR/350	Width 20mm	SC-OR/350tc	Width 20mm
SC-OR/351	Width 25mm	SC-OR/351tc	Width 25mm
SC-OR/352	Width 30mm	SC-OR/352tc	Width 30mm

### With tungsten carbide edge

## Swedish Pattern Chisel

200mm long

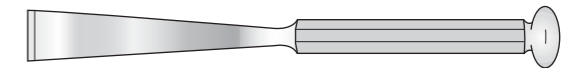

Code	Description	Code	Description
SC-OR/353	Width 10mm	SC-OR/355tc	Width 20mm
SC-OR/354	Width 15mm	SC-OR/356tc	Width 25mm
SC-OR/355	Width 20mm	SC-OR/357tc	Width 30mm
SC-OR/356	Width 25mm	SC-OR/356tc	Width 25mm
SC-OR/357	Width 30mm	SC-OR/357tc	Width 30mm

### With tungsten carbide edge

## Swedish Pattern Gouge

200mm long

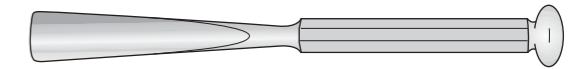

Code	Description	Code	Description
SC-OR/358	Width 10mm	SC-OR/358tc	Width 10mm
SC-OR/359	Width 15mm	SC-OR/359tc	Width 15mm
SC-OR/360	Width 20mm	SC-OR/360tc	Width 20mm
SC-OR/361	Width 25mm	SC-OR/361tc	Width 25mm

### With tungsten carbide edge

## Lambotte Osteotome

230mm long



### Straight

Code	Description
SC-OR/392	2mm wide
SC-OR/392a	4mm wide
SC-OR/392b	7mm wide
SC-OR/392c	15mm wide
SC-OR/392d	20mm wide
SC-OR/392e	25mm wide
SC-OR/392f	30mm wide
SC-OR/392g	38mm wide
SC-OR/392h	44mm wide
SC-OR/392i	50mm wide

### Curved

Code	Description
SC-OR/392j	15mm wide
SC-OR/392k	20mm wide
SC-OR/392m	25mm wide
SC-OR/392n	30mm wide
SC-OR/392o	38mm wide
SC-OR/392p	40mm wide
SC-OR/392q	44mm wide
SC-OR/392r	50mm wide



# Osteotomes, Chisels and Gouges

## Albee Osteotome

190mm long

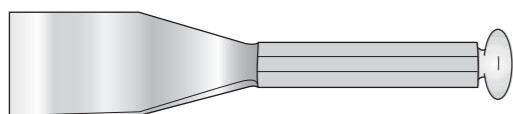

Code	Description
SC-OR/N062a	Width 38mm
SC-OR/N062b	Width 50mm

## Moore Hollow Osteotome

Rectangular, for curved standard stems



Code	Description
SC-OR/N008	135mm long
SC-OR/N008a	255mm long

## Small Osteotomes

150mm long



Code	Description
SC-OR/14-4	4mm wide
SC-OR/14-6	6mm wide
SC-OR/14-8	8mm wide

## Small Chisels

150mm long



Code	Description
SC-OR/18-4	4mm wide
SC-OR/18-4	6mm wide
SC-OR/18-4	8mm wide

## Small Gouges

150mm long



Code	Description
SC-OR/16-4	4mm wide
SC-OR/16-6	6mm wide
SC-OR/16-8	8mm wide

## Box Chisel

Blue acetal "Suregrip" handle, 285mm long



Code
SC-OR/N008b

## Alexander Gouge

Straight, 170mm long



Code	Description	Code	Description
SC-OR/290	Width 5mm	SC-OR/292	Width 9mm
SC-OR/291	Width 7mm	SC-OR/293	Width 11mm

## Partsch Gouge

Straight



140mm long		170mm long	
Code	Description	Code	Description
SC-OR/283	Width 3mm	SC-OR/294	Width 3mm
SC-OR/284	Width 4mm	SC-OR/287	Width 4mm
SC-OR/285	Width 5mm	SC-OR/295	Width 5mm
SC-OR/286	Width 6mm	SC-OR/288	Width 6mm
		SC-OR/289	Width 7mm

# Wire Cutters and Pliers

## Wire Cutting Pliers

Tungsten carbide edge, for cutting up to and including 6mm ø

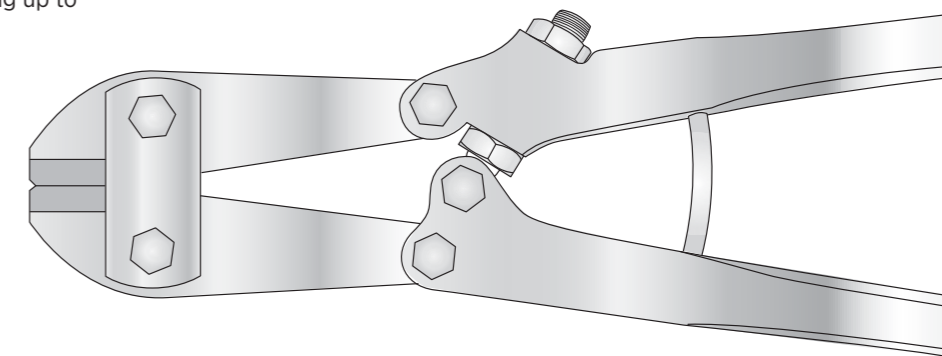

Code	Description
SC-OR/258	450mm long
SC-OR/259	560mm long

## Wire Cutting Pliers

Tungsten carbide edge, for cutting Kirschner wires up to and including 5.5mm ø

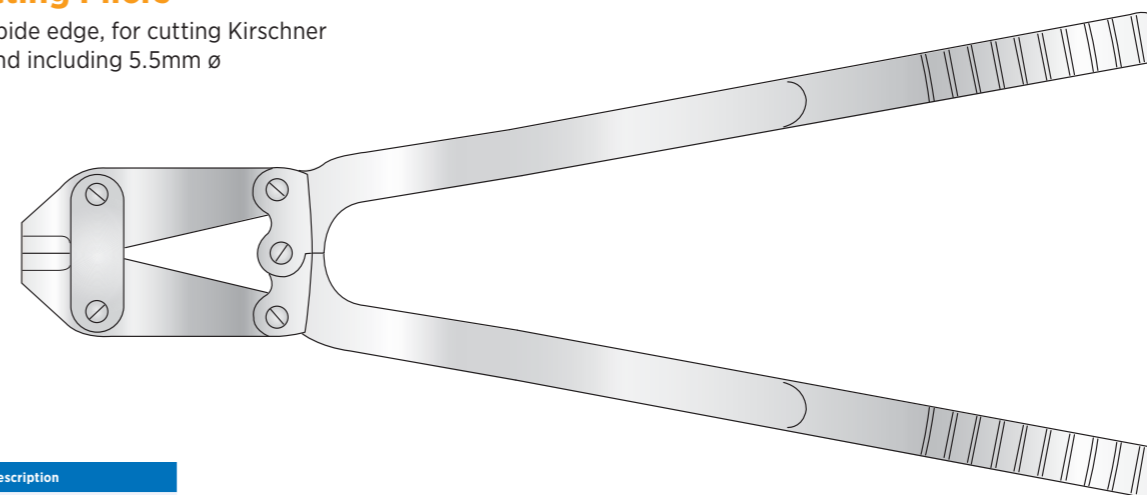

Code	Description
SC-OR/07a	480mm long

## Wire Cutting Pliers

Tungsten carbide edge, for cutting Kirschner wires up to 4mm ø

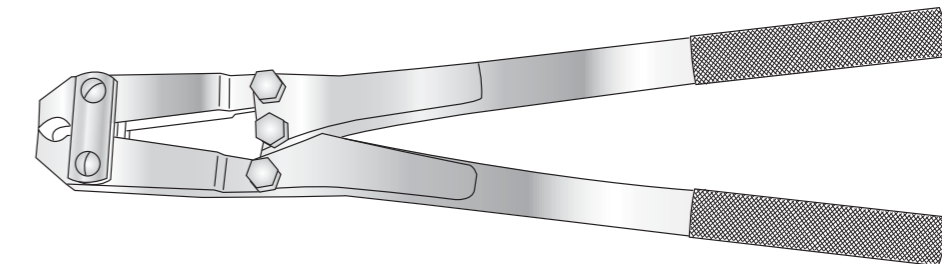

Code	Description
SC-OR/261	380mm long

## Wire Cutters and Pliers

### Top Cutter

Gold handles, tungsten carbide edge, for cutting Kirschner wire

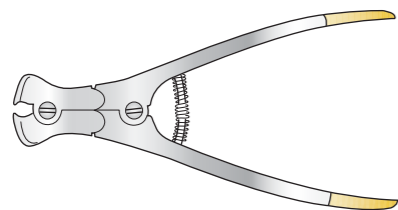

Code	Description
SC-OR/06	Up to 2.5mm, 215mm long
SC-OR/06a	Up to 1.5mm, 145mm long

### Top and Side Cutter

Small, gold handles, tungsten carbide edge, for cutting Kirschner wires up to 1.5mm ø

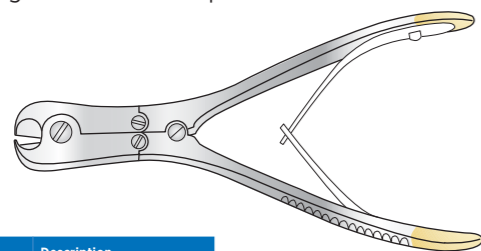

Code	Description
SC-OR/06b	175mm long

### Side Cutter

Compound action, angled tungsten carbide jaw, gold handles, for Kirschner wire up to 1.6mm ø

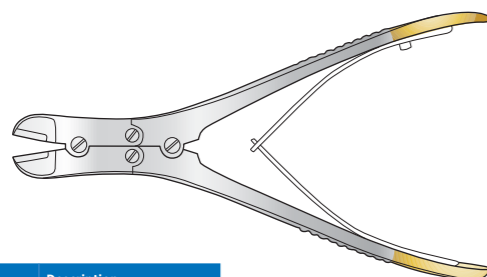

Code	Description
SC-OR/N060	180mm long

### Side Cutter

Gold handles, tungsten carbide edge, for cutting Kirschner wires up to 1.5mm ø

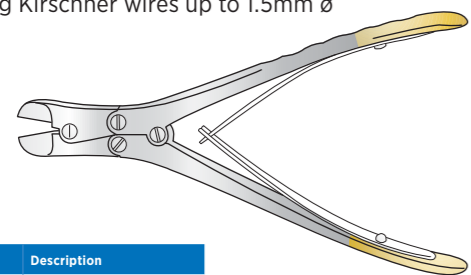

Code	Description
SC-OR/260	170mm long

### Side Cutter

Gold handles, tungsten carbide edge, jaws have rounded edges, for cutting Kirschner wires

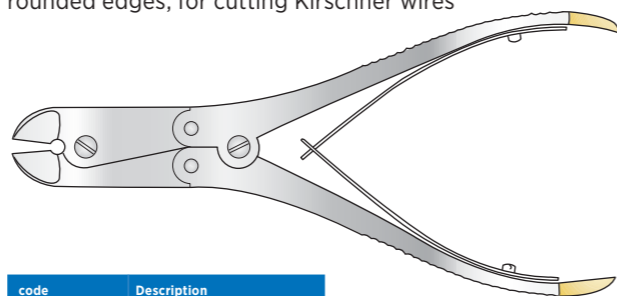

code	Description
SC-OR/331	Up to 2.5mm ø, 230mm long
SC-OR/332	Up to 2.2mm ø, 215mm long
SC-OR/333	Up to 1.5mm ø, 145mm long

### Wire Cutting Pliers

Gold handles, tungsten carbide edge, 120mm long

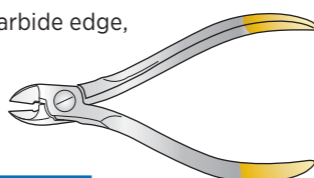

Code	Description
SC-OR/263	For wire up to 0.2mm ø
SC-OR/267	For wire up to 0.3mm ø
SC-OR/262	For wire up to 0.5mm ø
SC-OR/269	For wire up to 0.5mm ø 115mm long
SC-OR/268	For wire up to 0.7mm ø

### Orthopaedic Plier/Cutter

Stainless steel

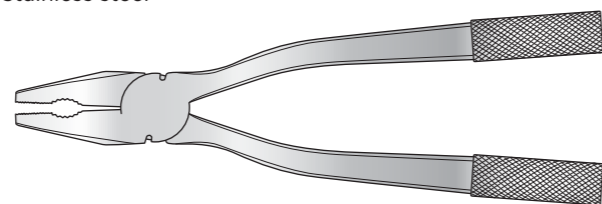

Code	Description
SC-OR/271b	180mm long
SC-OR/271c	220mm long

### Bone Plate Bender/Wire Cutter Pliers

For nipping and breaking off soft wire only  
Not suitable for Kirschner wires

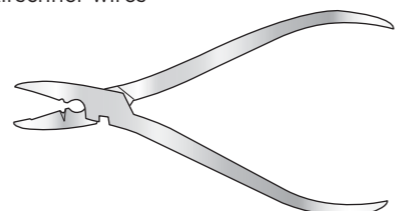

Code	Description
SC-OR/32a	150mm long

## Wire Cutters and Pliers

### Orthopaedic Plier/Cutter

Stainless steel, tungsten carbide edge, for cutting Kirschner wire up to 1.6mm

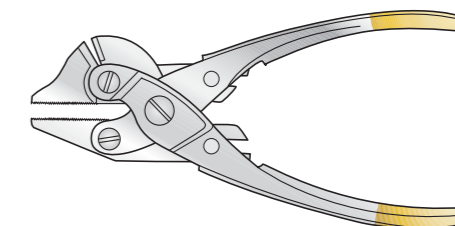

Code	Description
SC-OR/271a	TC 180mm long
SC-OR/271b	Non TC for cutting soft wire only, max cut 1.6mm, 180mm long

### Mole Grip Type Wrench

Stainless steel

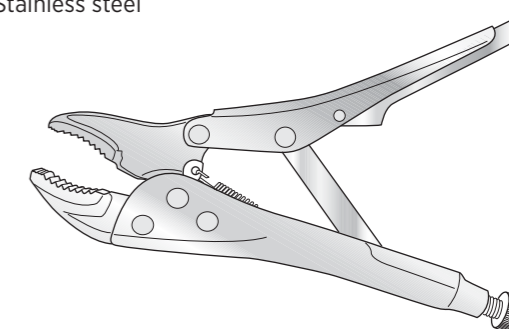

Code	Description
SC-OR/N052	190mm long

### Pliers for Wire

175mm long

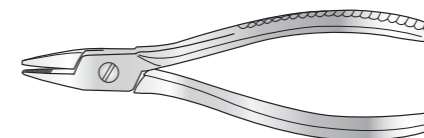

Code
SC-OR/273

Code
SC-OR/275

### Pliers for Bone Burrs

190mm long

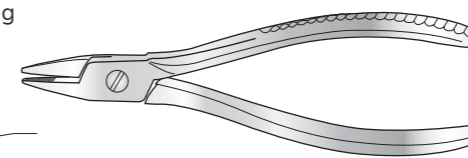

Code
SC-OR/274

### Orthopaedic Pliers

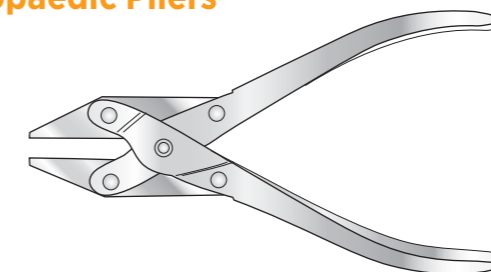

Code	Description
SC-OR/49b	185mm

## Sterile Arthrodesis & Kirschner Wires

- ✓ Highest grade implant quality stainless steel to ISO 5832-1
- ✓ Reduces risk of sharps injuries to Sterile Services personnel
- ✓ All popular sizes in stock and can manufacture any custom size, including threaded wires

Turn to page 175 to see our range of sterile Arthrodesis and Kirschner wires

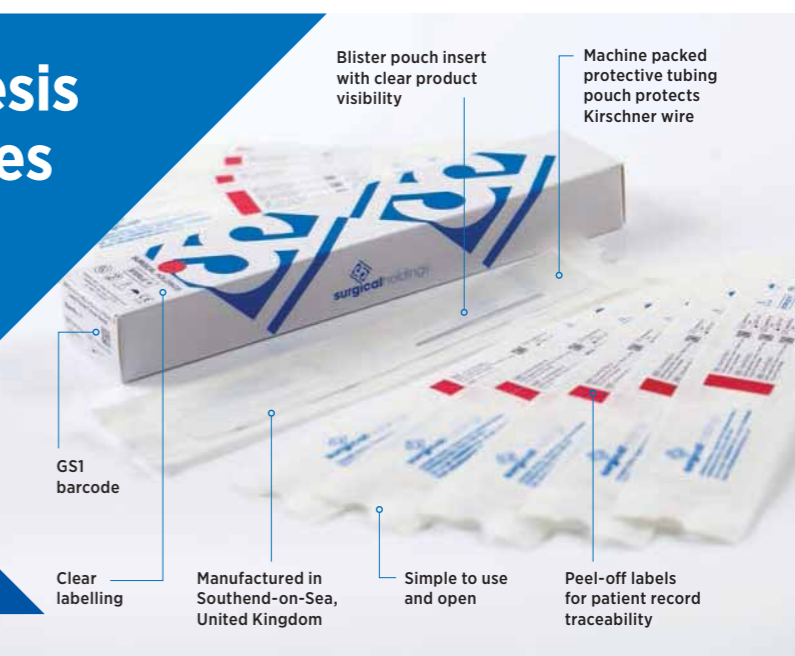

Blister pouch insert with clear product visibility

Machine packed protective tubing pouch protects Kirschner wire

GS1 barcode

Clear labelling

Manufactured in Southend-on-Sea, United Kingdom

Simple to use and open

Peel-off labels for patient record traceability

Wire Twister Biomet Type



Code	Description
SC-OR/49a	150mm long

Martin Cartilage Forceps

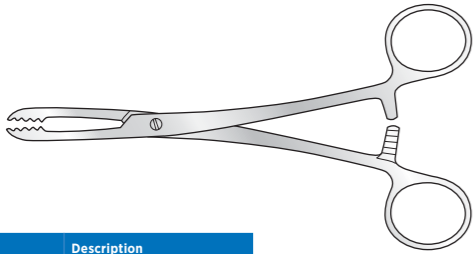

Code	Description
SC-OR/393	180mm long

Charnley Suture Forcep

Slotted, 1-2 teeth

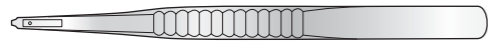

Code	Description
SC-OR/N045	180mm long

Suture Wire Cutting Scissors

Angled to cut soft wire only, max cut 1.2mm

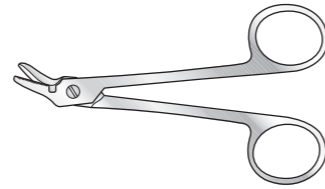

Code	Description
SC-OR/07b	120mm long

Suture Wire Cutting Scissors

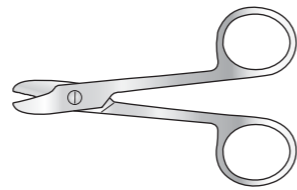

Code	Description
SC-OR/07c	110mm long

Mallet

With serrated head, 170mm long

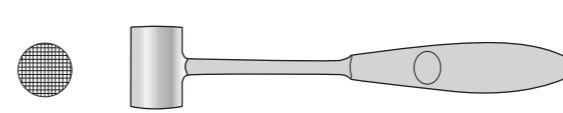

Code	Description
SC-OR/023	190 grams

Mallet

Blue acetal "Suregrip" handle, 275mm long

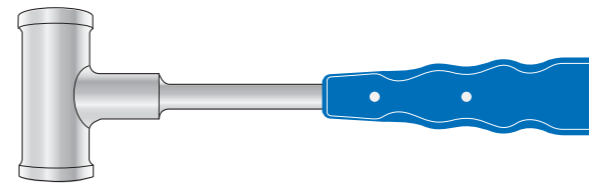

Code
SC-OR/270A-BH

Mallet

Stainless steel, 270mm long

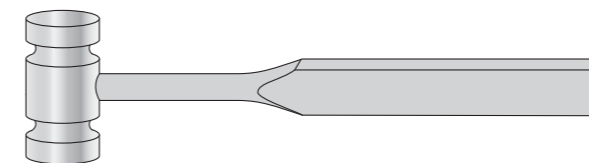

Code	Description
SC-OR/270	640 grams
SC-OR/271	1020 grams

Mallet

Stainless steel, with pistol grip\* 240mm long

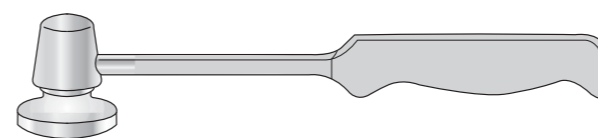

Code	Description
SC-OR/20	580 grams

\*ALSO AVAILABLE WITH BLUE ACETAL HANDLE

Mallet

Blue acetal, 240mm long

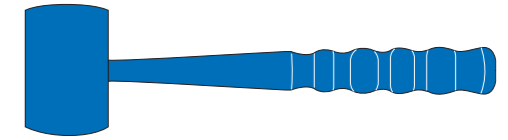

Code	Description
SC-OR/LEI001	340 grams, vertical end

Mallet

Blue acetal, 255mm long

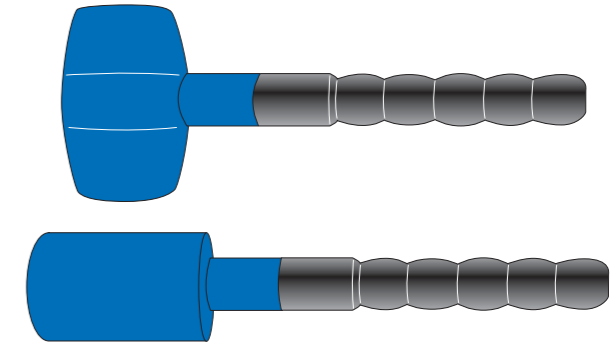

Code	Description
SC-OR/22a	520 grams, vertical end
SC-OR/22	650 grams, horizontal end

Heath Mallet

Stainless steel, 135mm long

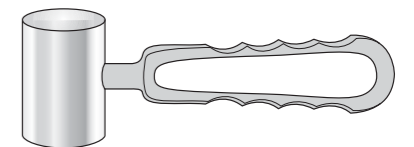

Code	Description	Code	Description
SC-OR/N044c	650 grams	SC-OR/N044	1150 grams
SC-OR/N044b	920 grams	SC-OR/N044a	1340 grams

Royal Cornwall Mallet

Stainless steel, with extended handle and strong welded head, 190mm long

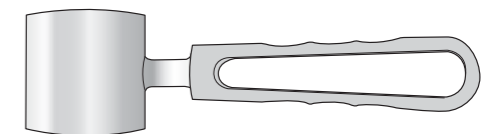

Code	Description
SC-OR/N044rc	1000 grams

Arthroscope Repair

Surgical Holdings' highly skilled and experienced technicians will return scopes to the manufacturer's original specification. All parts are brand new and have full traceability. Surgical Holdings also manufacture their own fibre optic light bundles.

18 month guarantee on the repair

OEM optical specification followed where possible

Personal collection and delivery

Laser welding for sheaths

ISO 13485 accredited  
As recommended by MHRA\* advice around endoscope storage and care

Free educational visits to our scope workshop and see all our repair facilities

\*MHRA Managing Medical Devices - April 2016

Book your endoscope repair by emailing [info@surgicalholdings.co.uk](mailto:info@surgicalholdings.co.uk)



# Mallets

## Orthopaedic Mallet

Surgical Holdings pattern, stainless steel, 170mm long

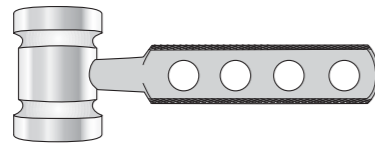

Code	Description
SC-OR/N055b	800 grams
SC-OR/N055	880 grams
SC-OR/N055a	1020 grams

## Orthopaedic Mallet

Stainless steel, Surgical Holdings pattern, one flat and one domed end, 180mm long

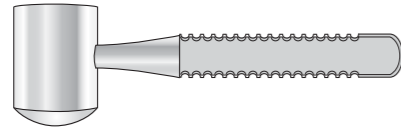

Code	Description
SC-OR/272a	960 grams
SC-OR/272c	750 grams

## Toffee Hammer

Stainless steel, one plain and one serrated side, 190mm long

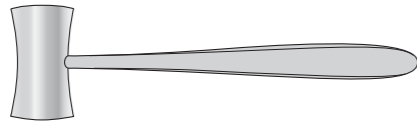

Code	Description
SC-OR/N047	280 grams

## Ombredanne Mallet

Stainless steel, one flat and one domed end

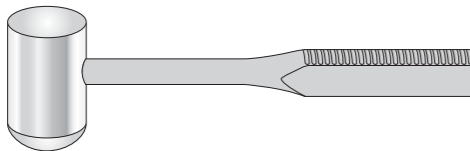

Code	Description
SC-OR/272	950 grams, 240mm long
SC-OR/272b	1110 grams, 270mm long

## Collin Mallet

Stainless steel, 205mm long

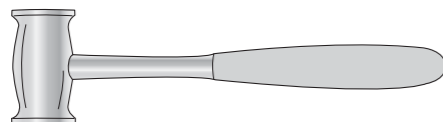

Code	Description
SC-OR/23	270 grams

## Kelsey Fry Mallet

With renewable acetal ends, 190mm long

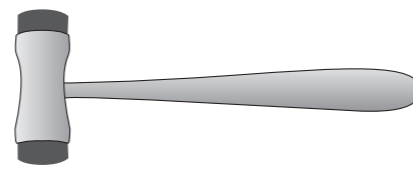

Code	Description
SC-OR/N047a	280 grams
SC-OR/N048	Replacement end - pair

## Surgical Holdings Orthopaedic Mallet

Stainless steel with blue acetal "Suregrip" handle 270mm long

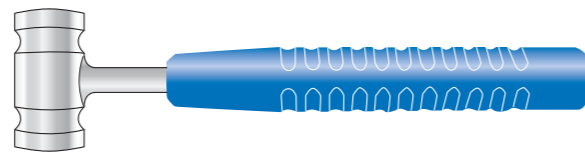

Code	Description	Code	Description
SC-OR/410	720 grams	SC-OR/412	900 grams
SC-OR/411	800 grams	SC-OR/413	970 grams

## Surgical Holdings Orthopaedic Mallet

Stainless steel with blue acetal "Suregrip" handle 200mm long

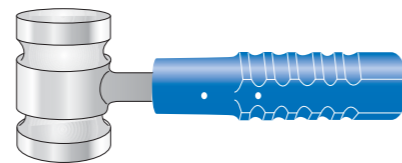

Code	Description	Code	Description
SC-OR/414BH	660 grams	SC-OR/416BH	1020 grams
SC-OR/415BH	790 grams	SC-OR/417BH	1400 grams

## Surgical Holdings Mallet

Stainless steel with blue acetal "Suregrip" handle domed faced head, 200mm long

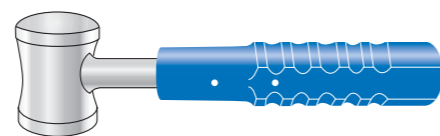

Code	Description
SC-OR/418BH	650 grams

# Raspatories, Files and Punches

## Putti Raspatory



Code	Description
SC-OR/12	300mm long

OTHER SHAPES AND CONFIGURATIONS ON REQUEST

## Bone File and Raspatory

Stainless steel

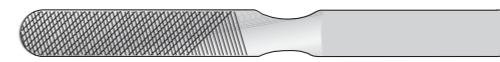

Code	Description
SC-OR/12a	215mm long

## Austin Moore Type Raspatory

Including tommy bar, 295mm long

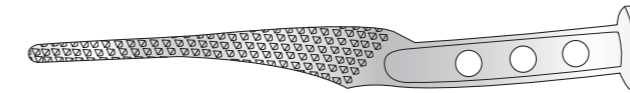

Code	Description
SC-OR/HP001	Standard
SC-OR/HP002	Narrow (not illustrated)

## Thompson Type Raspatory

Including tommy bar

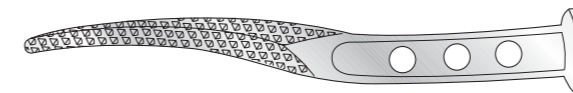

### Many other types available

Supply a drawing of the prosthesis - we will make the rasp in any batch size you require. The teeth will be chipped up at 0.75mm per face over and above the size of the prosthesis stem, to allow for cementing.

Code	Description
SC-OR/HP003	270mm long

## Miller Bone File

180mm long

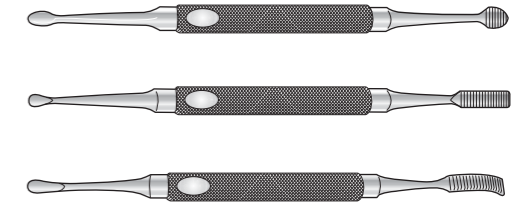

Code	Description
SC-OR/318	Short end
SC-OR/319	Slight curve
SC-OR/322	Full curve

## McGoey Punch

Double ended, 220mm long



4

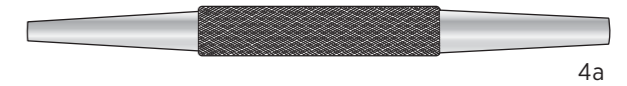

4a



4b

Code	Description
SC-OR/N04	13 x 19mm
SC-OR/N04a	6 x 10mm
SC-OR/N04b	13 x 6mm half round

## Smillie Bone Punch



Head size 15 x 19.5mm



Head size 9.5 x 15.5mm

Code	Description
SC-OR/N018	Straight 140mm long
SC-OR/N019	Cranked 175mm long

# Pushers, Impactors and Skids

# Elevators

## Charnley Cup Pusher

With nylon head

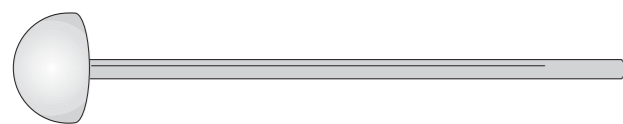

Code	Description
SC-OR/N020	295mm long

## Hardinge Cement Restrictor

With T handle

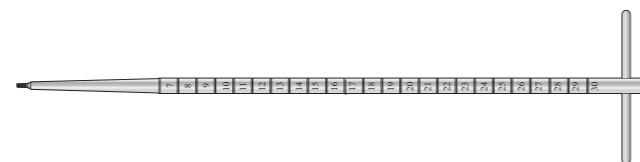

Code	Description
SC-OR/HR001	335mm long

## Charnley Prosthesis Pusher

Stainless steel handle with nylon insert



Code	Description
SC-OR/N021	180mm long

## Moore Femoral Head Extractor

With T handle

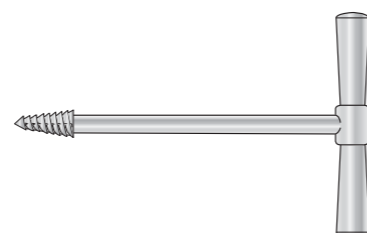

Code	Description
SC-OR/N005	150mm long
SC-OR/N006	205mm long

## Judet Impactor

Stainless steel handle with nylon head

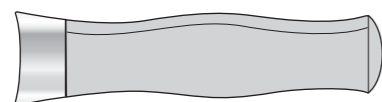

Code	Description
SC-OR/N009	140mm long

## Murphy Skids

Double ended, 355mm long



Code	Description
SC-OR/N007	Uncoated
SC-DIA/111	Coated

## Femoral Pusher

Head impactor, white Pomalux

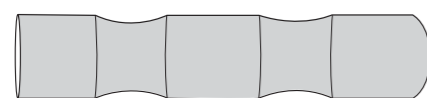

Code	Description
SC-OR/N053	31mm ø x 180mm long

## Murphy Skids

Single ended, 330mm long



Code	Description
SC-OR/N007a	Coated

## Adson Periosteal Elevator

Serrated grip, 165mm long

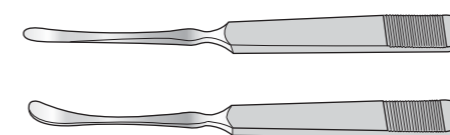

straight

Code	Description
SC-OR/N028	7mm wide

curved

Code	Description
SC-OR/N029	5mm wide
SC-OR/N030	7mm wide

## Langenbeck Elevator

Straight

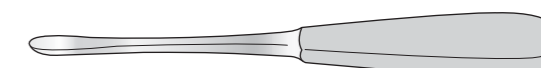

Code	Description
SC-OR/302	200mm long

## Bristow Periosteal Elevator

Sharp edge

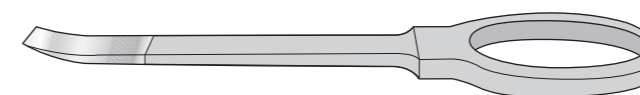

Code	Description
SC-OR/N010	240mm long

## MacDonald Dissector Double Ended



Code	Description
SC-GI/285	191mm long

## Doyen Periosteal Elevator

Satin finish handle

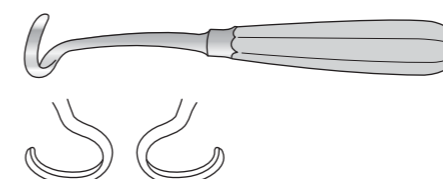

165mm long

Code	Description
SC-OR/N031	Right
SC-OR/N032	Left

180mm long

Code	Description
SC-OR/256	Right
SC-OR/255	Left

## Pennybacker Elevator

Curved, sharp, 6mm wide

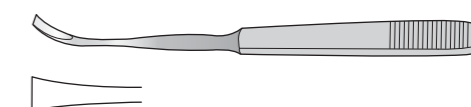

Code	Description
SC-OR/N025	170mm long

## Key Periosteal Elevator

190mm long



Code	Description
SC-OR/N023	10mm wide
SC-OR/N024	13mm wide

## Periosteal Elevator

Straight

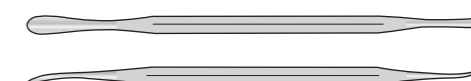

Code	Description
SC-OR/19a	175mm long

## Periosteal Elevator

Straight, 12 x 20mm, with blue acetal "Suregrip" handle



Code	Description
SC-OR/SH-5695	195mm long

## Periosteal Elevator

Curved, 5 x 25mm, with blue acetal "Suregrip" handle



Code	Description
SC-OR/SH-5696	185mm long

## Tudor Edwards Periosteal Elevator

For first rib, satin finish handle, 175mm long

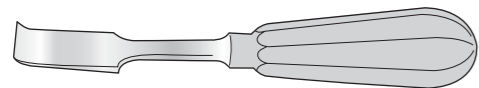

Code	Description
SC-OR/N026	12mm wide
SC-OR/N027	18mm wide

## Hohmann Bone Elevator

Matt finish, 160mm long

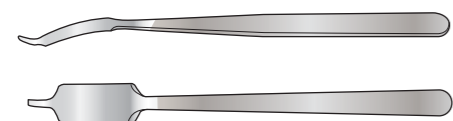

Code	Description
SC-OR/307a	6mm wide
SC-OR/307b	8mm wide
SC-OR/307d	10mm wide
SC-OR/307e	15mm wide

## Hohmann-Muller Spike Elevator

With narrow spade

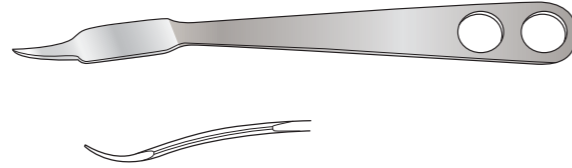

Code	Description
SC-OR/307f	220mm long, 10mm wide
SC-OR/307	230mm long, 12mm wide
SC-OR/308	240mm long, 18mm wide

## Hohmann-Aldinger Bone Elevator

Curved

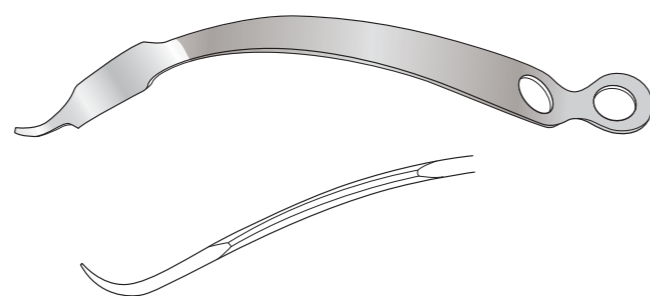

Code	Description
SC-OR/304	270mm long x 24mm wide

## Hohmann Bone Elevator

Curved

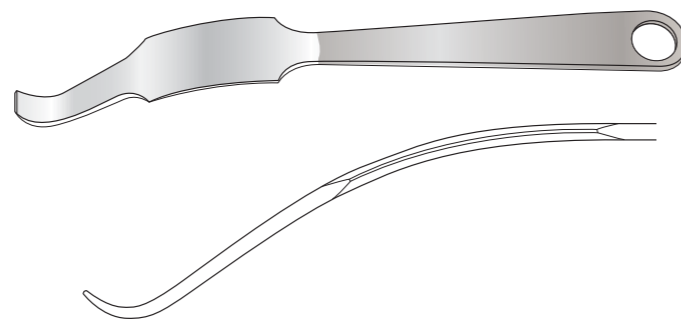

Code	Description
SC-OR/305	285mm long x 34mm wide

## Hohmann Bone Lever

Curved, Leicester Royal Infirmary pattern

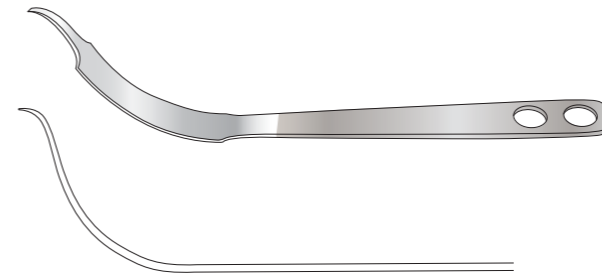

Code	Description
SC-OR/LGH-HOH	340mm long x 23mm wide

## Schumacher Bone Elevator

290mm long

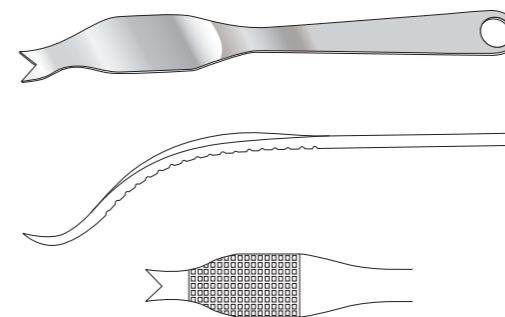

Code	Description
SC-OR/307k	35mm wide, 18mm at edge

## Muller Soft Tissue Retractor

40mm wide

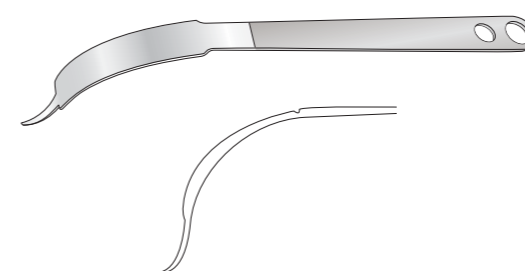

Code	Description
SC-OR/307aNOR	410mm long
SC-OR/307bNOR	300mm long

## Wagner Bone Elevator

220mm long

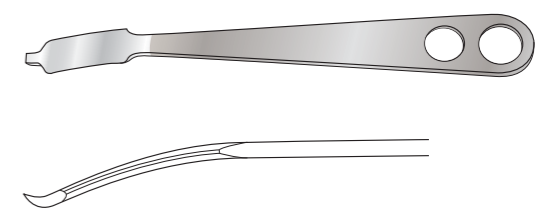

Code	Description
SC-OR/307h	17mm wide

## Lange-Hohmann Bone Elevator

250mm long

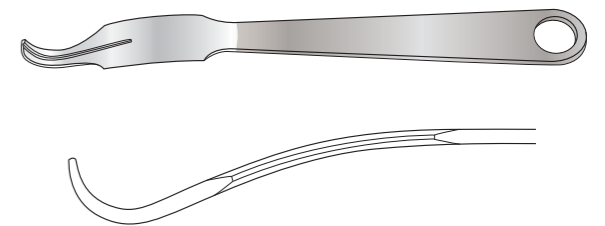

Code	Description
SC-OR/307i	24mm wide

## Schumacher Bone Elevator

345mm long

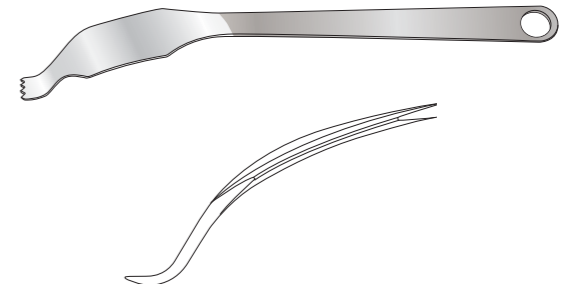

Code	Description
SC-OR/307j	37mm wide, 18mm at edge

## Retractors and Bone Levers

### Fakuda Type Retractor

230mm long

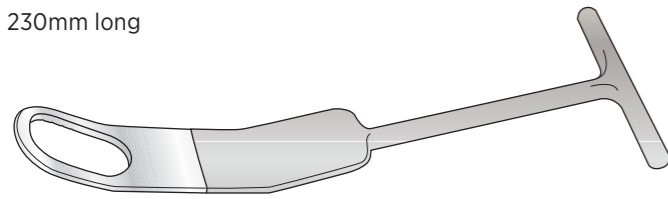

Code  
SC-OR/SH5507

### Hohmann Retractor

45° angle, 200mm long

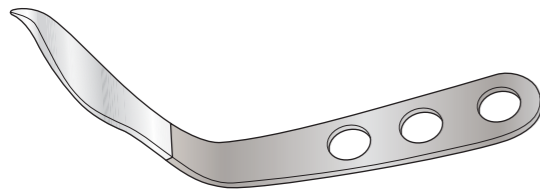

Code  
SC-OR/SH5394

### Hohmann Tapered Spike Retractor

225mm overall length

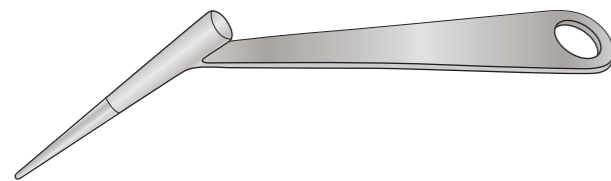

Code  
SC-OR/308a

### Posterior Bone Lever

230mm long



Code  
SC-OR/308f

### Trethowan Bone Lever

Bent, ring handle 222mm long, 280mm long

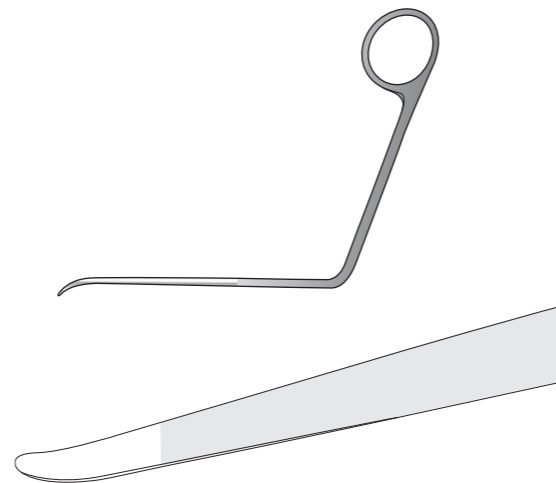

Code	Description
SC-OR/no17b	90° angle
SC-OR/no17c	70° angle (illustrated)
SC-OR/no17d	45° angle

## Hermann Laparoscopic Instruments

Offering more than 50 years of quality and safety, know-how and innovation, technology and precision.

Surgical Holdings provide you with:

- 2 year warranty
- Unique interchangeable handles and working parts
- Handle and rod design gives extra stability and robustness
- We perform maintenance and modifications in-house
- Custom designs



Manufactured in Germany

info@surgicalholdings.co.uk

+ Exclusive distributor

## Saws, Shears and Knives

### Gigli Saw Handles

Per pair

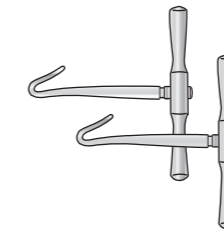

Code	Description
SC-OR/08	65mm long

### Charnley Saws

Code	Description
SC-OR/10c	500mm long
SC-OR/11c	700mm long

### Gigli Saws

Code	Description
SC-OR/09	300mm long
SC-OR/10	500mm long
SC-OR/11	700mm long

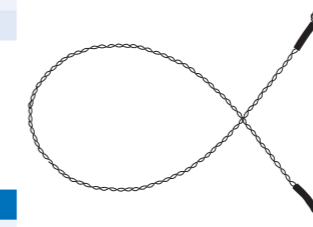

### Collin Rib Shears

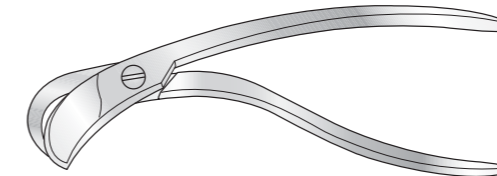

Code	Description
SC-OR/001	195mm long

### Guys Tenotomy Knife



Code	Description
SC-OR/N046	140mm long

### Smillie Menisectomy Knife

175mm long



Code	Description
SC-OR/048	Straight

### Smillie Menisectomy Knife

Protruding beak at base, 175mm long

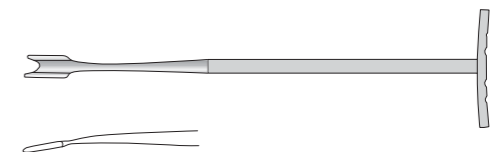

Code	Description
SC-OR/N0048a	Curved to right
SC-OR/N0048b	Curved to left

## Screw and Plate Instruments

### Allen Key Sets

Bright guard

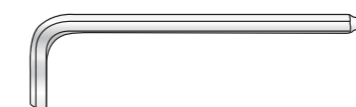

Code	Description
SC-OR/N051	1.5mm - 10mm

Size mm	Overall Length
1.5	63mm
2.0	77mm
2.5	87mm
3.0	93mm
4.0	104mm
5.0	120mm
6.0	141mm
7.0	147mm
8.0	158mm
10.0	180mm

To order quote SC-OR/N051 then add size required e.g. SC-OR/N051-1.5

### Orthopaedic Ruler Stainless Steel



Code	Description
SC-OR/51a	Metric, 300mm

Denham Pin

Temporary implants, material conforms to BS 7252: Part 1: 1997. ISO 5832-1: 1997. Comp.D. CE marking available on request.



Code	Size
SC-DP/1-3SE	3.96mm dia x 203mm long trocar/3 side end
SC-DP/1SQ	3.96mm dia x 203mm long trocar/square end
SC-DP/2-3SE	3.96mm dia x 229mm long trocar/3 side end
SC-DP/2SQ	3.96mm dia x 229mm long trocar/square end

Code	Size
SC-DP/3-3SE	4.76mm dia x 203mm long trocar/3 side end
SC-DP/3SQ	4.76mm dia x 203mm long trocar/square end
SC-DP/4-3SE	4.76mm dia x 229mm long trocar/3 side end
SC-DP/4SQ	4.76mm dia x 229mm long trocar/square end

THREE SIDED END OR SQUARE END IN STOCK  
OTHER SIZES AVAILABLE

Steinmann Pins

Temporary implants, material conforms to BS 7252: Part 1: 1997. ISO 5832-1: 1997. Comp.D. CE marking available on request



IPTT = trocar/trocar ends



IPTS = trocar/trocar with one screw end



IPTE = trocar/square end



IPTE3 = trocar/with 3 sided end

Various specs available - contact us for full information

Ø mm*	Ø mm*
1.58	3.96
2.00	4.36
2.38	4.76
2.78	6.00
3.17	6.35
3.57	8.00

LENGTHS 150, 180, 200, 250mm  
\*Other lengths and diameters available

When ordering, use prefix letters with size following  
e.g. Trocar with one screw end  
Ø4.76mm = IPTS/476

Bohler Stirrup

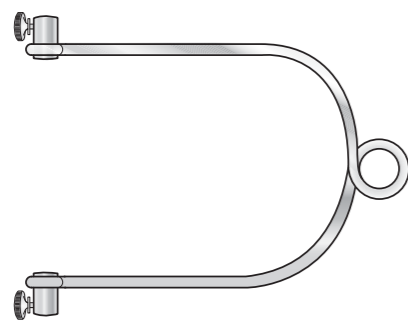

Code	Description
SC-OR/N001	Small 89 x 102mm
SC-OR/N002	Medium 114 x 165mm
SC-OR/N003	Large 152 x 241mm

Steinmann Pin Cap with Screw

Code	Description
SC-OR/54b-4	4mm ø
SC-OR/54c	Replacement screw



Sterile Kirschner and Arthrodesis Wires

Temporary implants, material conforms to BS 7252: Part 1: 1997. ISO 5832-1: 1997. Comp.D.

Sterile Trocar/ Sterile Trocar Arthrodesis Wires

Code	Size
KWHS325A-S	0.8mm x 70mm
KWHS037-S	0.9mm x 70mm
KWHS055-S	0.9mm x 75mm
KWHS091-S	0.9mm x 100mm
KWHS127-S	0.9mm x 125mm
KWHS145-S	0.9mm x 140mm
KWHS0009-S	0.9mm x 150mm
KWHS163-S	0.9mm x 180mm
KWHS038-S	1.0mm x 70mm
KWHS056-S	1.0mm x 75mm
KWHS092-S	1.0mm x 100mm
KWHS269-S	1.1mm x 90mm
KWHS272-S	1.1mm x 100mm
KWHS275-S	1.1mm x 115mm
KWHS278-S	1.1mm x 125mm
KWHS281-S	1.1mm x 140mm
KWHS0010C-S	1.1mm x 150mm

Code	Size
KWHS290-S	1.1mm x 200mm
KWHS0019B-S	1.25mm x 150mm
KWHS039-S	1.2mm x 70mm
KWHS093-S	1.2mm x 100mm
KWHS129-S	1.2mm x 125mm
KWHS147-S	1.2mm x 140mm
KWHS0010B-S	1.2mm x 150mm
KWHS165-S	1.2mm x 180mm
KWHS183-S	1.2mm x 200mm
KWHS040-S	1.4mm x 70mm
KWHS094-S	1.4mm x 100mm
KWHS112-S	1.4mm x 115mm
KWHS130-S	1.4mm x 125mm
KWHS148-S	1.4mm x 140mm
KWHS0011-S	1.4mm x 150mm
KWHS166-S	1.4mm x 180mm
KWHS184-S	1.4mm x 200mm

Code	Size
KWHS005-S	1.6mm x 50mm
KWHS041-S	1.6mm x 70mm
KWHS095-S	1.6mm x 100mm
KWHS113-S	1.6mm x 115mm
KWHS131-S	1.6mm x 125mm
KWHS0012-S	1.6mm x 150mm
KWHS167-S	1.6mm x 180mm
KWHS185-S	1.6mm x 200mm
KWHS283-S	1.8mm x 200mm
KWHS096-S	2.0mm x 100mm
KWHS114-S	2.0mm x 115mm
KWHS132-S	2.0mm x 125mm
KWHS0013-S	2.0mm x 150mm
KWHS168-S	2.0mm x 180mm
KWHS186-S	2.0mm x 200mm

Sterile Trocar/Sterile Kirschner Wires (Pack of 10 Sterile Singles)

Code	Size
KWHS325-S	0.8mm x 70mm
KWHS043-S	0.9mm x 70mm
KWHS061-S	0.9mm x 75mm
KWHS097-S	0.9mm x 100mm
KWHS133-S	0.9mm x 125mm
KWHS151-S	0.9mm x 140mm
KWHS0014A-S	0.9mm x 150mm
KWHS169-S	0.9mm x 180mm
KWHS044-S	1.0mm x 70mm
KWHS062-S	1.0mm x 75mm
KWHS098-S	1.0mm x 100mm
KWHS270-S	1.1mm x 90mm
KWHS273-S	1.1mm x 100mm
KWHS276B-S	1.1mm x 115mm
KWHS279-S	1.1mm x 125mm
KWHS282-S	1.1mm x 140mm
KWHS285-S	1.1mm x 150mm

Code	Size
KWHS291-S	1.1mm x 200mm
KWHS0015A-S	1.25mm x 150mm
KWHS045-S	1.2mm x 70mm
KWHS099-S	1.2mm x 100mm
KWHS135-S	1.2mm x 125mm
KWHS153-S	1.2mm x 140mm
KWHS0019-S	1.2mm x 150mm
KWHS171-S	1.2mm x 180mm
KWHS189-S	1.2mm x 200mm
KWHS046-S	1.4mm x 70mm
KWHS100-S	1.4mm x 100mm
KWHS118-S	1.4mm x 115mm
KWHS136-S	1.4mm x 125mm
KWHS154-S	1.4mm x 140mm
KWHS0021-S	1.4mm x 150mm
KWHS172-S	1.4mm x 180mm
KWHS190-S	1.4mm x 200mm

Code	Size
KWHS011-S	1.6mm x 50mm
KWHS047-S	1.6mm x 70mm
KWHS101-S	1.6mm x 100mm
KWHS119-S	1.6mm x 115mm
KWHS137-S	1.6mm x 125mm
KWHS0017-S	1.6mm x 150mm
KWHS173-S	1.6mm x 180mm
KWHS191-S	1.6mm x 200mm
KWHS475-S	1.8mm x 200mm
KWHS102-S	2.0mm x 100mm
KWHS120-S	2.0mm x 115mm
KWHS138-S	2.0mm x 125mm
KWHS0018-S	2.0mm x 150mm
KWHS174-S	2.0mm x 180mm
KWHS192-S	2.0mm x 200mm

OTHER SIZES, FULL AND PARTIALLY THREADED STYLES ARE ALSO AVAILABLE PLEASE CONTACT US WITH YOUR REQUIREMENTS.





## Fine Hand Set

Includes: small stille type mallet 17cm long and 2mm, 4mm, 6mm, 8mm, 10mm and 12mm osteotomes

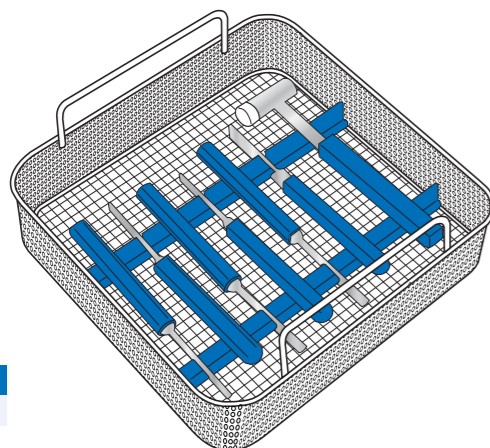

Code  
SH-6969

## Flexible Chisels and Blades

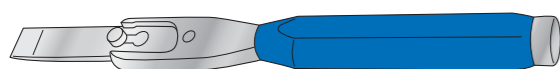

Code	Description
SC-OR/593	Allen key for flat chisel blades introducer handle 185mm long
SC-OR/594	Chisel blade 5mm for introducer handle
SC-OR/594A	Chisel blade 5mm curved for introducer handle
SC-OR/595	Chisel blade 10mm for introducer handle
SC-OR/595A	Chisel blade 10mm curved for introducer handle
SC-OR/596	Chisel blade 15mm for introducer handle
SC-OR/596A	Chisel blade 15mm curved for introducer handle
SH-6954	Introducer handle for flat chisel blades 185mm long

## Mini Fine Hand Osteotomes

With blue acetal handle



Code	Description
SH-6956	2mm wide, 165mm long
SH-6957	4mm wide, 165mm long
SH-6958	6mm wide, 165mm long
SH-6959	8mm wide, 165mm long
SH-6960	10mm wide, 165mm long
SH-6961	12mm wide, 165mm long

## Mini-Lexer Gouges

With blue acetal handle



Code	Description
SC-OR/587-04	4mm wide, 18cm long
SC-OR/587-06	6mm wide, 18cm long
SC-OR/587-08	8mm wide, 18cm long
SC-OR/587-10	10mm wide, 18cm long

## Mini-Lexer Osteotome and Gouge Set

Includes 4mm, 6mm, 8mm, 10mm gouges 18cm long and 2mm, 4mm, 6mm, 8mm and 10mm osteotomes 18cm long

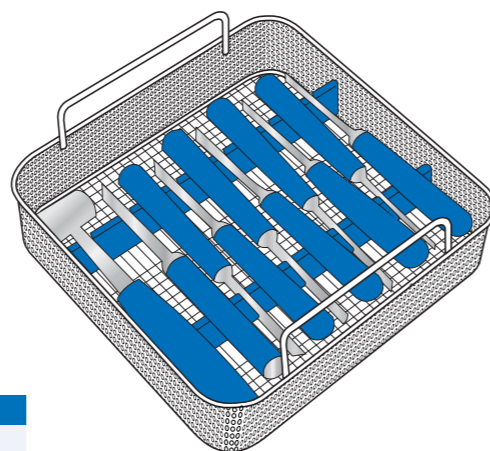

Code  
SC-OR/587

## Mini-Lexer Osteotomes

With blue acetal handle



Code	Description
SC-OR/588-02	2mm wide, 18cm long
SC-OR/588-04	4mm wide, 18cm long
SC-OR/588-06	6mm wide, 18cm long
SC-OR/588-08	8mm wide, 18cm long
SC-OR/588-10	10mm wide, 18cm long

## Removable Flexible Chisel and Blade Set

With blue acetal handle

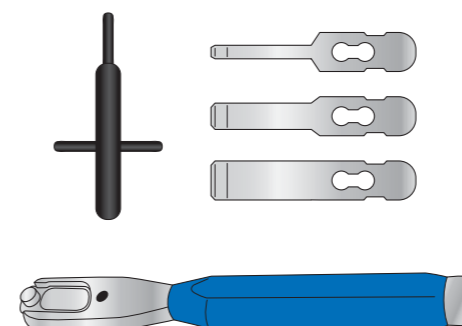

Code	Description
SH-7002	5mm, 10mm and 16mm straight
SH-7002A	5mm, 10mm and 16mm curved

## Small Mallet

Small mallet 340 gram 210mm long with one flat and one round end fitted with blue acetal handle

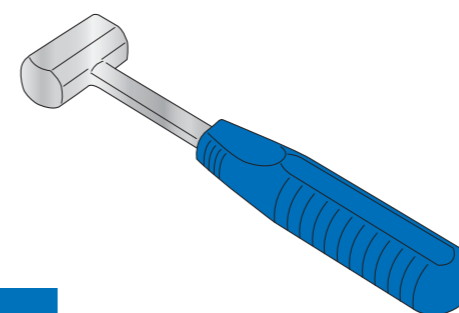

Code  
SH-6955

## Chirobloc Hand Immobiliser

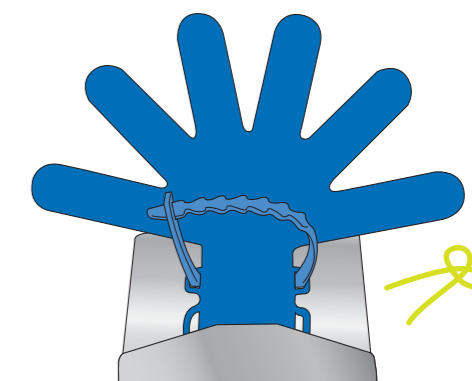

Code	Description
CB3	Chirobloc 3 with wrist strap and 5 ForgetMeNotes
CBL	Chirobloc Ballast
CBM	Chirobloc Large
CBP	Chirobloc Small
FMN2B.B	Chirobloc ForgetMeNot Blue
FMN2B.Y	Chirobloc ForgetMeNot Yellow

## Small Stille Type Mallet

Ultra fine mallet 180mm long with one nylon head fitted with a blue acetal handle 180 gram

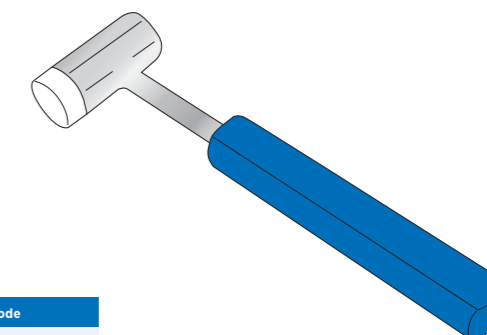

Code  
SC-OR/580

# Shoulder Instruments

## Kolbel Soft Tissue Retractor

Single-pronged, angled, 190mm

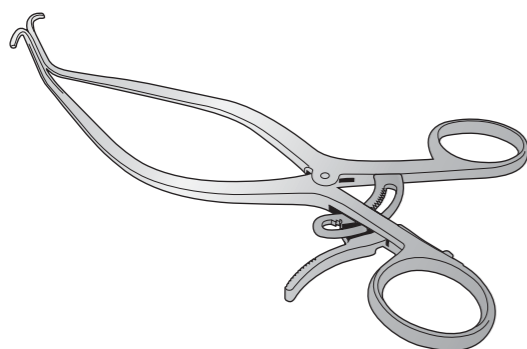

Code  
SH004637943

## Kolbel Soft Tissue Retractor

Single-pronged, straight, very fine tips, 190mm

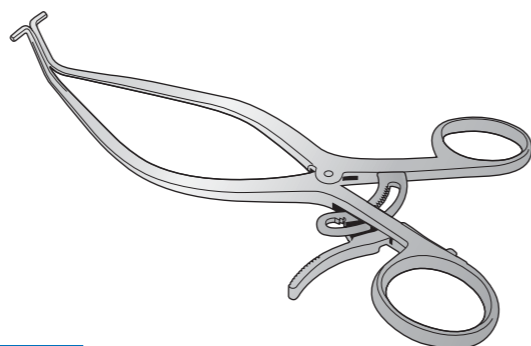

Code  
SH004636943

## Kolbel Soft Tissue Retractor

Double pronged, angled, 190mm

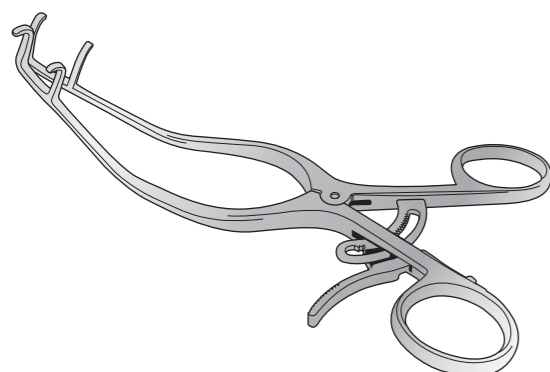

Code  
SH004454965

## Capsule Spreader

Single-pronged, fine, 90° curved, 165mm

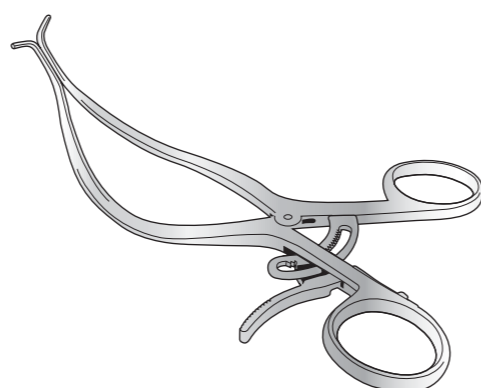

Code  
SH004455954

## Fukuda-Kujat Humeral Head Retractor

35mm, wide blade, 225mm

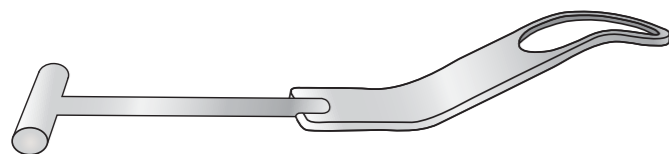

Code  
SH0046351113

# Shoulder Instruments

## Kolbel Self Retaining Glenoid Retractor

With ball snap-fit, slightly curved, 200mm

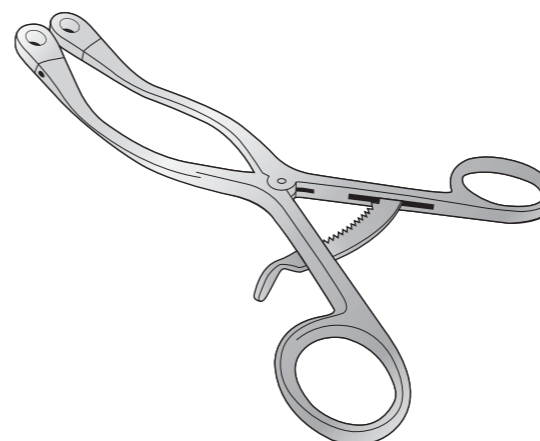

Code  
SH004459965

## Kolbel Glenoid Retractor

Double-pronged, angled tips, 300mm, 18mm straight



Code  
SH004458416

## Kolbel Glenoid Retractor

Double-pronged, angled tips, 300mm, 15mm strongly curved



Code  
SH004457V318416

## Pair of Kolbel Self Retaining Glenoid Retractor Blades

With ball fit

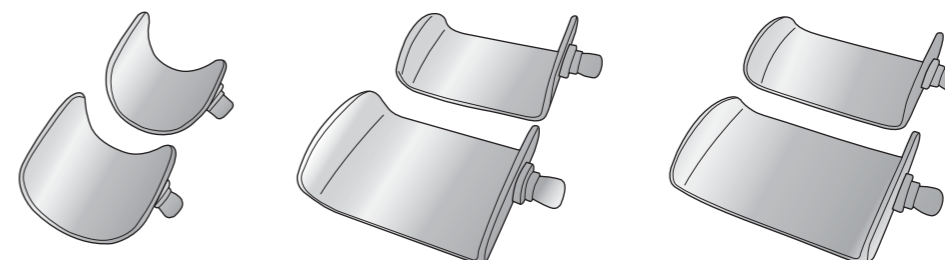

Code	Description
SH004460954	Pair of blades size 36 x 36mm
SH004461V316	Pair of blades size 53 x 36mm
SH004462V319	Pair of blades size 68 x 36mm



# Plastic/Oral

Scissors	181
Needle Holders	182
Forceps	183
Raspatories and Elevators	184
Raspatories	185
Spring Forceps, Hooks and Picks	187
Retractors	188
Osteotomes, Chisels and Gouges	190
Miscellaneous	191

**i** FOR INFORMATION ON BLACK AND GOLD BOWS SEE PAGE 23

## Scissors

Plastic/Oral

### Kilner Scissors

Rounded blades, 115mm long

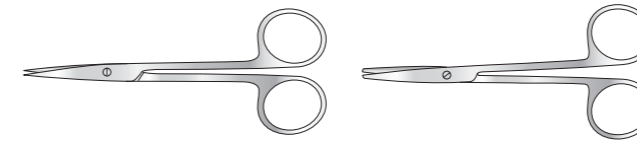

Code	Description
SC-PL/001a	Straight, sharp points
SC-PL/001b	Curved, blunt points

### McIndoe Scissors

Curved on flat, round tapering ends

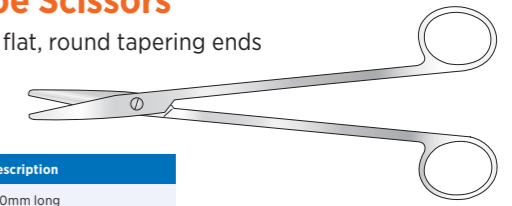

Code	Description
SC-PL/007	190mm long

### Stevens Tenotomy Scissors

Supercut, 114mm long

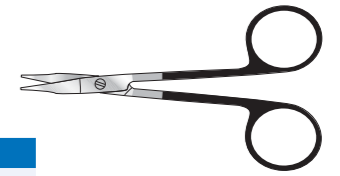

Code	Description
SC-OP/424	Curved/blunt
SC-OP/425	Curved/sharp
SC-OP/426	Straight/blunt
SC-OP/427	Straight/sharp

### Aufricht Dissecting Scissors

Heavy pattern, triangular blades, 140mm long

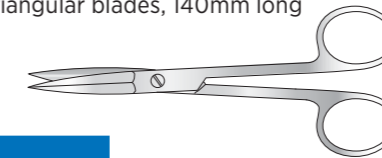

Code	Description
SC-PL/002a	Straight
SC-PL/002d	Curved

### Aufricht Dissecting Scissors

Light pattern, 150mm long

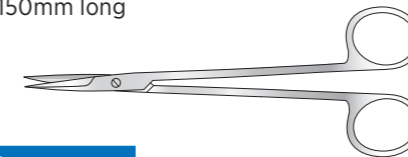

Code	Description
SC-PL/002b	Straight
SC-PL/002c	Curved

### Cartilage Cutting Scissors

Fine points, serrated edges

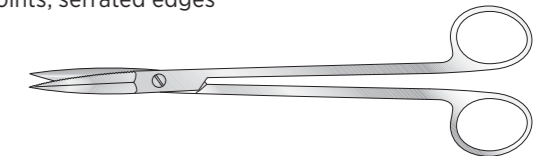

Code	Description
SC-PL/009	190mm long

### Scissors

Curved, sharp points

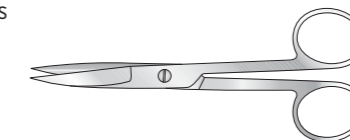

Code	Description
SC-PL/004	130mm long

### Gorney Supercut Scissors

Rhytidectomy scissor, tungsten carbide, one micro serrated and one razor sharp edge

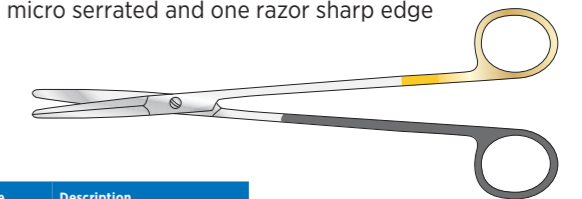

Code	Description
SC-PL/085a	125mm long
SC-PL/085	200mm long, straight
SC-PL/085b	200mm long, curved

### Scissors

Angular, for cutting cartilage, wire cutting notch

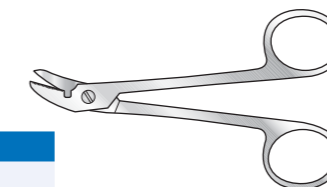

Code	Description
SC-PL/006	127mm long

### Fickling (Cathcart) Scissors

Angled

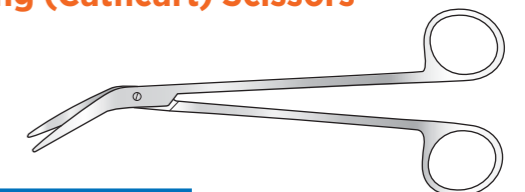

Code	Description
SC-PL/049	180mm long

# Needle Holders

FOR INFORMATION ON BLACK AND GOLD BOWS SEE PAGE 23

# Forceps

## Foster Scissor/Needle Holder

Fenestrated jaw, 125mm long

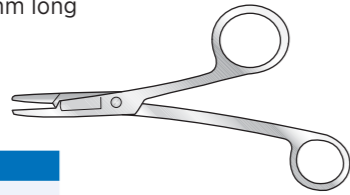

Code	Description
SC-PL/010a	Left

## Derf Needle Holder

Tungsten carbide insert, with two gold bows

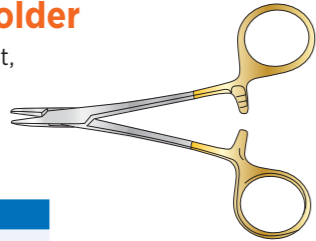

Code	Description
SC-PL/013	115mm long
SC-PL/013L	125mm long

## Masing Needle Holder

Tungsten carbide insert, one angled bow

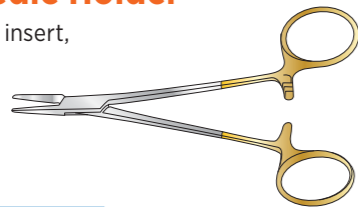

Code	Description
SC-GI/009R	130mm long

## Castroviejo Needle Holder

Code	Description
SC-OP/021	140mm long, with catch
SC-OP/020	140mm long, without catch

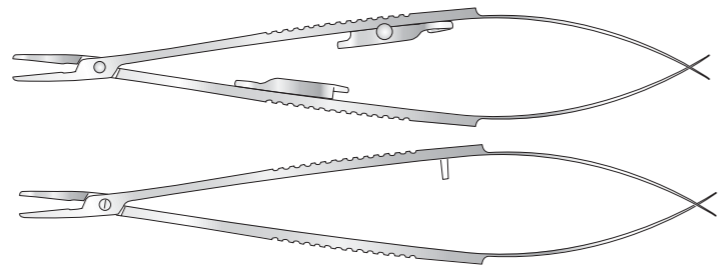

### Diamond dust jaws

Code	Description
SC-THO/060	180mm long, without catch
SC-THO/061	200mm long, without catch
SC-THO/062	215mm long, without catch

ALSO AVAILABLE WITH CATCH - ADD SUFFIX CTH TO CODE

### Tungsten carbide jaws

Code	Description
SC-THO/058a	180mm long
SC-THO/058	200mm long
SC-THO/059	215mm long

ALSO AVAILABLE WITH CATCH - ADD SUFFIX CTH TO CODE

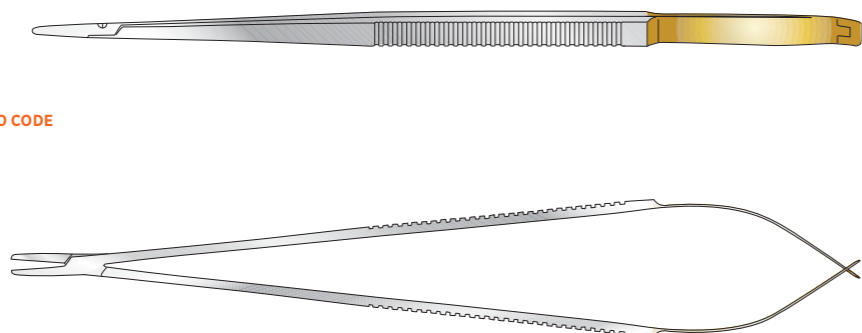

## Lawrence Needle Holder

Fine jaw, 150mm long

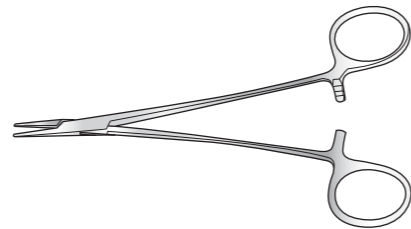

Code	Description
SC-PL/012a	
SC-PL/012b	Tungsten carbide, with two gold bows

## Reverdin Suture Needle

With automatic eye, 203mm long

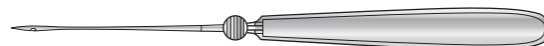

Code	Description
SC-PL/013a	Fully curved
SC-PL/013b	Curved
SC-PL/013c	Slightly curved
SC-PL/013d	Straight

## Mustarde Suture Holding Forceps

Convex and concave jaw

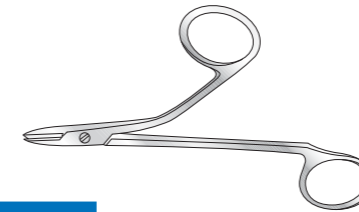

Code	Description
SC-PL/011	133mm long

## Fickling Artery Forceps

190mm long

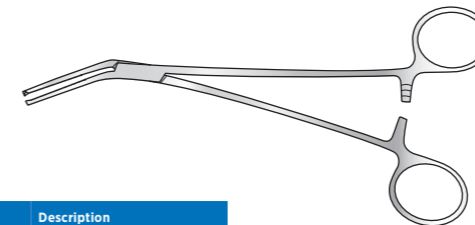

Code	Description
SC-PL/044a	Serrated
SC-PL/044b	1-2 teeth

## Asch Septum Forceps

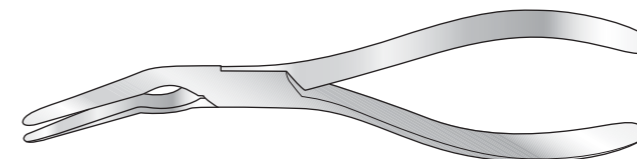

Code	Description
SC-PL/031	235mm long

## Jansen-Middleton Septum Forceps

Compound action, 178mm long

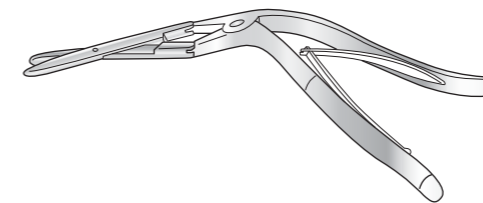

Code	Description
SC-PL/032	5mm bite

## Walsham Septum Straightening Forceps

220mm long

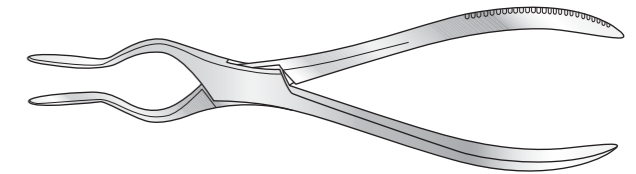

Code	Description
SC-PL/030a	Straight
SC-PL/030b	Right
SC-PL/030c	Left

## Bone Cutting Forceps

Straight, compound action

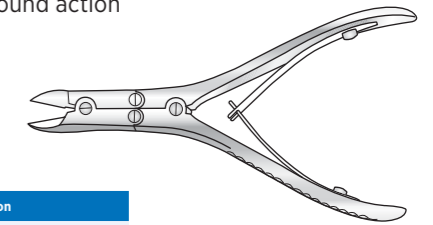

Code	Description
SC-PL/033	146mm long

## Ward Bone Cutting Forceps

Slightly angled on flat

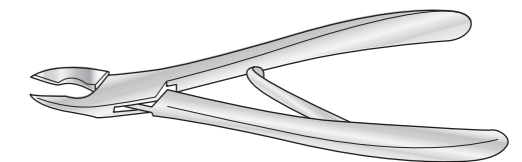

Code	Description
SC-PL/038	178mm long

## Symmetry Vein Strippers

- Proven, cost effective removal of saphenous varicose veins
- Eliminate the need to clean and process them after use
- 30-year heritage of quality

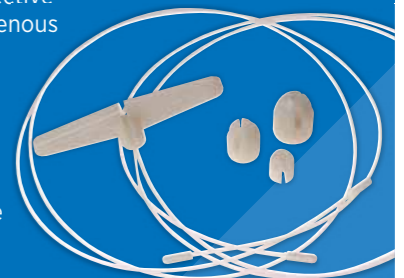

info@surgicalholdings.co.uk

## Cleft Palette Raspatory

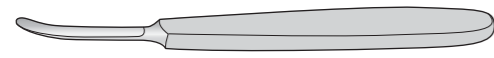

Code	Description
SC-PL/091	Curved downwards
SC-PL/092	Curved upwards

## Cleft Palette Raspatory

Curved upwards

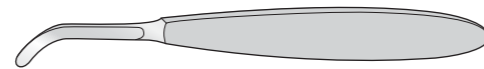

Code	Description
SC-PL/091	Left
SC-PL/092	Right

## McIndoe Raspatory

For cleft palette, spoon end, 170mm long



Code	Description
SC-/PL088	Small
SC-/PL089	Medium
SC-/PL090	Large

## Farabeuf Elevator

Light, 160mm long

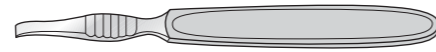

Code	Description
SC-PL/024	12mm curved
SC-PL/024a	8mm curved

## Howarth Elevator



Code	Description
SC-PL/025	220mm long

## Syme Periosteal Elevator

Double ended



Code	Description
SC-PL/046	170mm long

## Cryer Elevator

150mm long

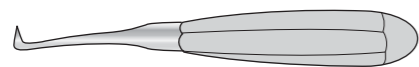

Code	Description
SC-PL/069	Right
SC-PL/069a	Left

## Coupland Elevator

Curved, 150mm long

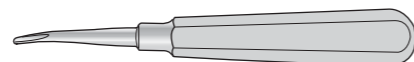

Code	Description
SC-PL/068	3mm wide
SC-PL/068a	3.5mm wide
SC-PL/068b	4mm wide

## Aufricht Raspatory

9mm wide, 220mm long

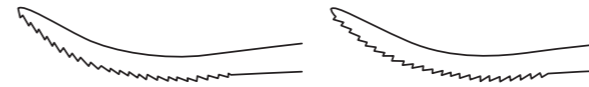
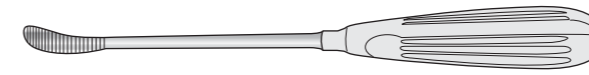

Code	Description
SC-PL/095	Up stroke
SC-PL/095a	Down stroke

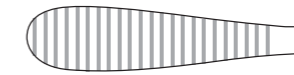

## Durogrip Raspatory

7mm wide, 205mm long



12/14 teeth

Code	Description
SC-PL/096	12/14 teeth
SC-PL/096a	16/20 teeth
SC-PL/096b	24/30 teeth
SC-PL/096c	36/44 teeth
SC-PL/096d	52/62 teeth

## Fomon Raspatory

6.5 and 7.5mm wide, 215mm long



Code	Description
SC-PL/097	Chequered
SC-PL/097a	Knotched

## Gallagher Raspatory

190mm long

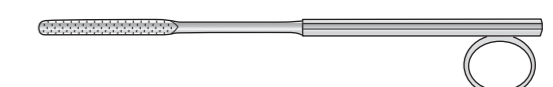

Code
SC-PL/098

## Joseph Raspatory

Chequered, 165mm long



Code	Description
SC-PL/099	Fine, 7.5mm
SC-PL/099a	Coarse, 9mm

## Lewis Raspatory

8mm wide, 175mm long

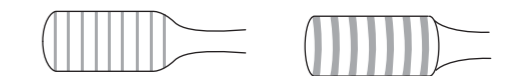

Code	Description
SC-PL/100	Fine teeth
SC-PL/100a	Coarse teeth

# Raspatories

## Maltz Raspatory

180mm long

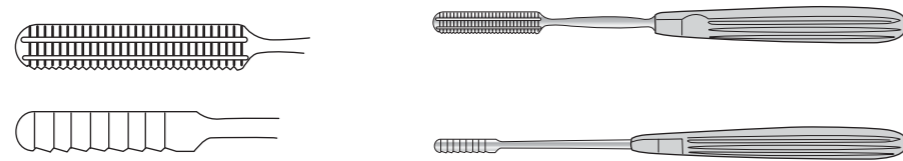

Code	Description
SC-PL/101	Straight, 9mm
SC-PL/101b	Straight, 5mm
SC-PL/101c	Curved, 5mm

## Miller Raspatory

180mm long

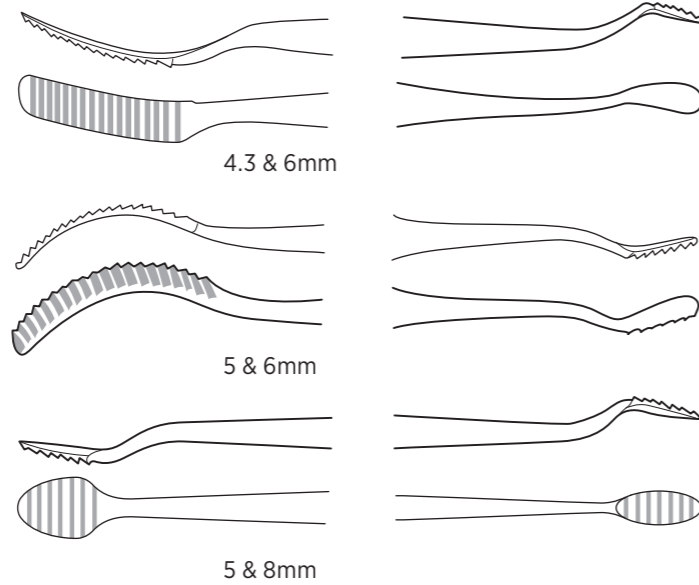

Code	Description
SC-PL/102	4.3 & 6mm
SC-PL/102a	5 & 6mm
SC-PL/102b	5 & 8mm

## Passivation Process

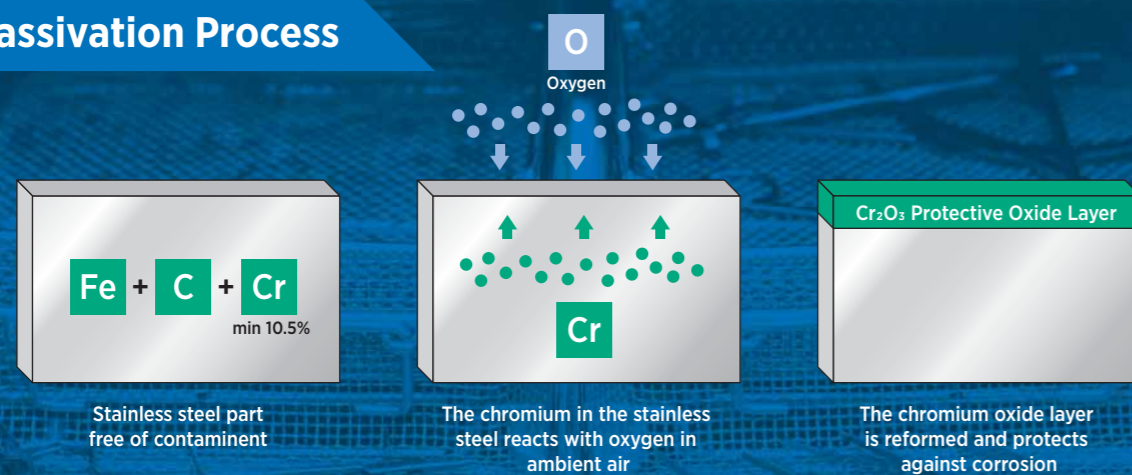

### Did you know...

**Stainless steel is self passivating which provides natural corrosion resistance.**

Passivation is the natural process that occurs to a surgical instrument containing chromium. The chromium in the stainless steel naturally reacts with oxygen in the air, creating the very thin passive layer which protects the surface of the steel.

# Spring Forceps, Hooks and Picks

## Gillies Dissecting Forceps

152mm long



Code	Description
SC-PL/052	1 x 2 teeth, 152mm long

## McIndoe Dissecting Forceps

152mm long



Code	Description
SC-PL/053a	1-2 teeth
SC-PL/053b	Serrated

## Waugh Dissecting Forceps

Fine, serrated



Code	Description
SC-GI/261	152mm long
SC-GI/262	178mm long
SC-GI/263	203mm long

## College Pattern Stopping and Dressing Forceps

152mm long



Code	Description
SC-PL/048	Serrated

## Mustarde Dissecting and Suture Holding Forceps

Combined double hooked jaws



Code	Description
SC-PL/050	156mm long

## Childe Approximating Forceps

With magazine for Michel clips

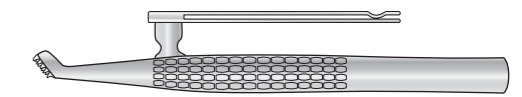

Code	Description
SC-PL/073	180mm long

## Mitchell Trimmer

165mm long



Code	Description
SC-ENT/013	

## Dental Pick



Code	Description
SC-PL/067	160mm long

## Gillies Skin Hook

190mm long



Code	Description
SC-PL/065a	Standard
SC-PL/065b	Half Size

## Joseph Double Skin Hook

165mm long



Code	Description
SC-PL/056a	

## Kleinert Kutz Skin Hooks



Code	Description
SC-PL/109	16cm large
SC-PL/108	16cm medium
SC-PL/107	16cm small

## Alms Skin Retractor

Self retaining

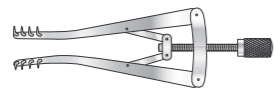

Code	Description
SC-PL/060	70mm long
SC-PL/060a	100mm long

## Kilner Retractor

Double ended, cat's paw



Code	Description
SC-PL/056	152mm long

## Kilner Alae Retractor

85mm long



Code	Description
SC-PL/063a	10mm
SC-PL/063b	13mm

## Austin Kay Retractor

85mm long

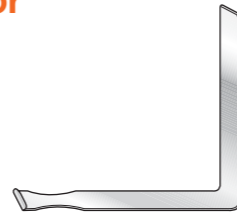

Code	Description
SC-PL/074	16mm wide

## Bowdler Henry Retractor

170mm long

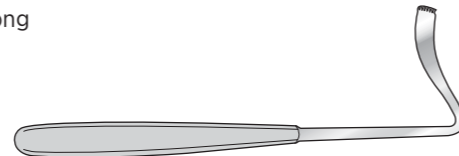

Code	Description
SC-PL/076	12mm wide

## Tongue Retractor

190mm long

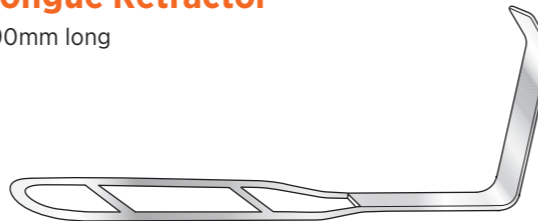

Code	Description
SC-PL/071	12mm wide

## Cheek Retractor

140mm long

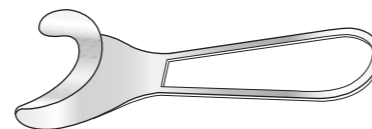

Code	Description
SC-PL/078	40mm wide

## Ragnell Davis Retractor

140mm long



Code	Description
SC-PL/074a	

## Flap Retractor

180mm long

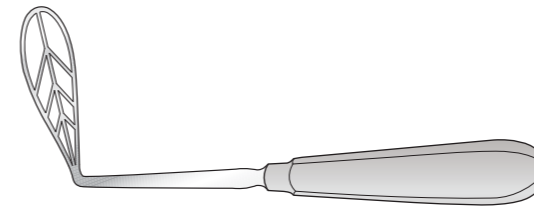

Code	Description
SC-PL/079	32mm wide

## Kilner Nasal Retractor

152mm long



Code	Description
SC-PL/061a	7mm wide

## Hajek Retractor

Upper lip, 165mm long

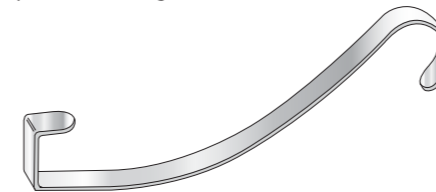

Code	Description
SC-PL/059	20mm wide

## Freece Oral Retractor

150mm long

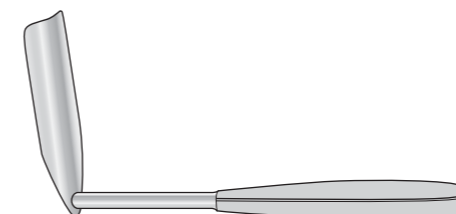

Code	Description
SC-PL/080	33mm wide

## Kilner Cheek Retractor

Double ended, 167mm long



Code	Description
SC-PL/058a	Small, 19mm and 25mm wide
SC-PL/058b	Large, 29mm and 35mm wide

## Laster Cheek Retractor

110mm long

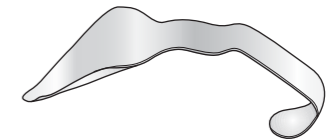

Code	Description
SC-PL/081	35mm wide

## Symmetry Skin Markers

Designed to provide a permanent skin marking solution for intact skin that won't wash off while preparing a patient for a procedure

- Protects risk of cross contamination
- Sterile Skin Markers require no preoperative preparation
- Packaged with a flexible, plastic ruler that follows body contours for easy marking and reference photos
- Available in standard tip for broad clear lines as well as in micro tips for extra precision
- Packaged 36 pre-sterile Skin Markers per box

Choice of standard tips or micro tips



info@surgicalholdings.co.uk



**Bovie offer Electrosurgery units from 10 watts, suitable for Desiccation, all the way up to 300 units.**

We recommend the A1250S as the all round unit, for plastic surgery as it has both cut and coagulate power, up to 120 watts.



For information on the full Bovie range email [info@surgicalholdings.co.uk](mailto:info@surgicalholdings.co.uk)

# Osteotomes, Chisels and Gouges

# Miscellaneous

## Ward (East Grinstead) Osteotome

Square handle, 178mm long



Code	Description
SC-PL/040aeg	3mm wide
SC-PL/040beg	5mm wide

## Gillies (French Pattern) Osteotome

140mm long



Code	Description
SC-PL/026	3mm wide
SC-PL/026a	5mm wide
SC-PL/026b	7mm wide
SC-PL/026c	9mm wide
SC-PL/026g	11mm wide
SC-PL/026d	16mm wide

## Jenkins Chisel

140mm long



Code	Description
SC-PL/027a	2mm wide
SC-PL/027b	4mm wide
SC-PL/027c	6mm wide
SC-PL/027d	8mm wide
SC-PL/027e	10mm wide

## McIndoe Nasal Chisel

152mm long



Code	Description
SC-PL/028a	5mm wide
SC-PL/028b	7mm wide
SC-PL/028c	9mm wide
SC-PL/028d	11mm wide

## Silver Nasal Chisel

182mm long



Code	Description
SC-PL/029a	Straight
SC-PL/029b	Curved to right
SC-PL/029c	Curved to left

## Pterigoideus (Maxilla) Chisel

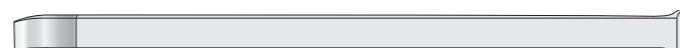

Code	Description
SC-PL/087	255mm long

## Tilley Septum Gouge

V shaped, straight



Code	Description
SC-PL/043	127mm long

## Fickling Dental Mallet

191mm long

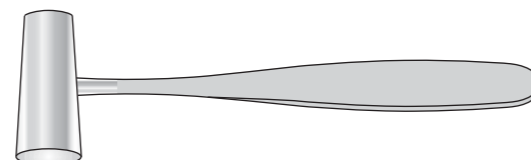

Code	Description
SC-PL/044	25mm ø, tapering head

## Silver Skin Graft Knife

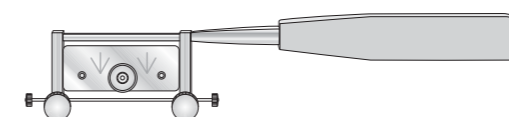

Code	Description
SC-PL/015a	190mm long

## Eckhoff Mapping Pen



Code	Description
SC-PL/019	145mm long
SC-PL/019a	Nibs packs of 10

## Sommerland Surgical Marking Pen

Adjustable four-pointed tip



Code	Description
SC-PL/020	152mm long

## Gillies Suction Tube

Control valve, 180mm long

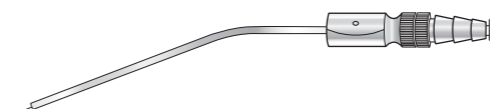

Code	Description
SC-PL/075a	2.5mm
SC-PL/075b	3mm
SC-PL/075c	3.5mm

## Watson Skin Graft Knife

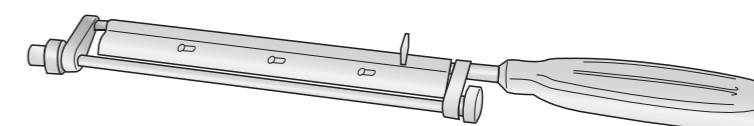

Code	Description
SC-PL/017	Right-handed
SC-PL/017L	Left-handed

## Doyen Mouth Gag

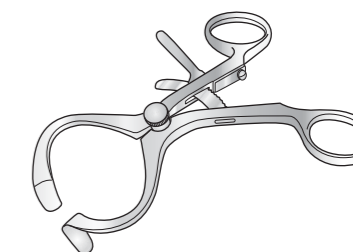

Code	Description
SC-ENT/88d	Adult
SC-ENT/88e	Child

## Fergusson Ackland Mouth Gag

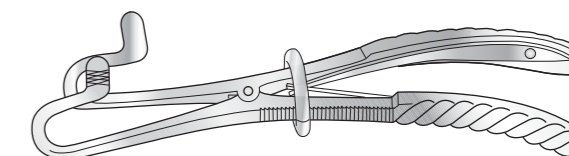

Code	Description
SC-ENT/209	Adult, 210mm
SC-ENT/209a	Child, 155mm

## Dental Cartridge Syringe

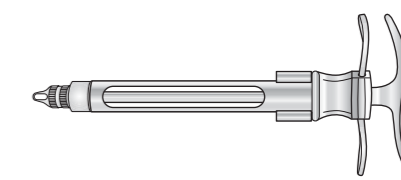

Code	Description
SC-PL/072	115mm long



## Miscellaneous

### Freeman Areola Nipple Sizer

1.5mm

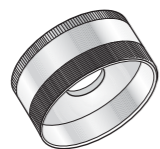

Code	Description
SC-PL/NIP25	25mm ø
SC-PL/NIP40	40mm ø
SC-PL/NIP45	45mm ø
SC-PL/NIP50	50mm ø
SC-PL/NIP55	55mm ø

### Kelsey Fry Bone Awl

148mm long

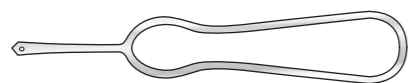

Code	Description
SC-PL/039a	Straight
SC-PL/039b	Curved

### Joseph Nasal Saw

Blade 35mm long

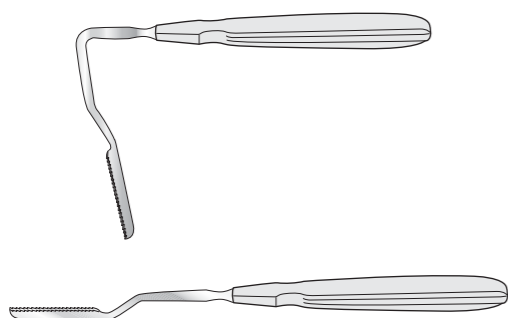

#### Horizontal shaft

Code	Description
SC-PL/034a	Cranked right
SC-PL/034b	Cranked left

#### Vertical shaft

Code	Description
SC-PL/034c	Cranked right
SC-PL/034d	Cranked left

### Unna Comedo Expressor Double Ended Curette

2mm / 1mm holes



Code	Description
SC-PL/035	135mm long

### Lang Steel Scoop

Double ended



Code	Description
SC-PL/064	7mm x 4mm, 140mm long

### McHardy Curette

136mm long



Code	Description
SC-PL/036	1mm, 1.5mm, and 2mm ø

### MacEwen Curette

Combined with seeker, 165mm long



Code	Description
SC-PL/045a	Oval
SC-PL/045b	Round

## Nero Smooth Cut Scissors

A ceramic-coated range of scissors with unbeatable durability, life cycle cost, anti-glare, cleaning efficacy, and the smoothest ever performance.

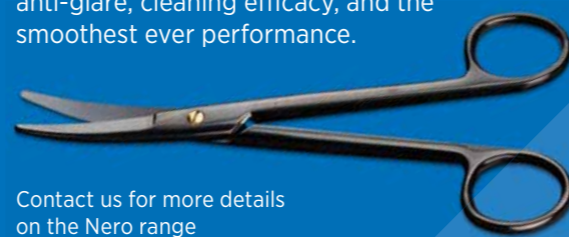

Contact us for more details on the Nero range

[info@surgicalholdings.co.uk](mailto:info@surgicalholdings.co.uk)

## Post Mortem/ Autopsy

Scalpels and Knives	194
Scissors	196
Bone Cutting Forceps	198
Rib Shears	199
Dissecting Forceps	200
Needle Holder	200
Forceps	201
Clamps	201
Raspatory	201
Saws	202
Gouges	203
Chisels	203
Mallets	204
Probes	204
Retractor	204
Needles	204
Scalpel Blade Remover	204



# Scalpels and Knives

## Baron Scalpel Handle

130mm long



Code	Description
SC-PM/003	No 3
SC-PM/004	No 4

## Scalpel Handle

127mm long

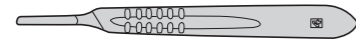

Code	Description
SC-PM/007	No 3
SC-PM/008	No 4
SC-PM/008a	No 4 L
SC-PM/001a	No 7

## Solid Forged Scalpel

Stainless steel  
140mm long



Code	Description
SC-PM/91	Blade length 25mm

## Solid Forged Scalpel

Stainless steel  
160mm long



Code	Description
SC-PM/92	Blade length 40mm

## Solid Forged Scalpel

Stainless steel  
165mm long



Code	Description
SC-PM/93	Blade length 50mm

## Solid Forged Scalpel

Stainless steel  
178mm long



Code	Description
SC-PM/94	Blade length 70mm

## Catlin Knife

Solid forged stainless steel



Code	Description
SC-PM/011	Blade length 152mm

## Cartilage Knife

Solid forged stainless steel



Code	Description
SC-PM/012	Blade length 133mm
SC-PM/013	Blade length 101mm

## Resection Knife

Solid forged stainless steel

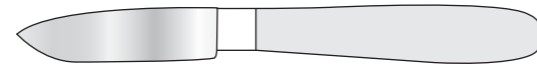

Code	Description
SC-PM/017	Blade length 76mm

## Pelvic Organ Knife

Stainless steel, curved, double edged

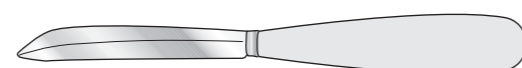

Code
SC-PM/020

# Scalpels and Knives

## Slicing Knife

For brain or organ,  
solid forged stainless steel,  
22mm blade



Code	Description
SC-PM/009NH	Blade length 254mm
SC-PM/010NH	Blade length 152mm

## Brain Knife

Solid forged stainless steel  
handle, 25mm blade



Code	Description
SC-PM/014	Blade length 254mm
SC-PM/016	Blade length 314mm
SC-PM/018	Blade length 254mm, 30mm blade

## Organ Knife

Solid forged stainless steel,  
old style, 25mm blade

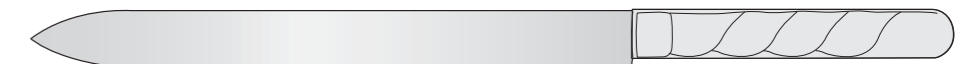

Code	Description
SC-PM/014NH	Blade length 254mm
SC-PM/016NH	Blade length 314mm

## Organ Knife and Saw

Solid forged stainless steel, 22mm blade



Code	Description
SC-PM/017NH	Blade length 255mm

## Organ Knife



Code	Description
SC-PM/100NH	Blade length 150mm, 22mm blade

## Bistoury Knife

Probe end, curved, 70mm blade



Code	Description
SC-PM/023	176mm long

## Rib Knife

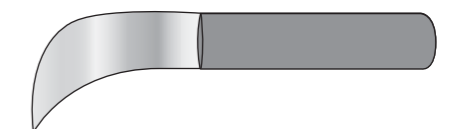

Code
SC-PM/025

# Scissors

FOR INFORMATION ON BLACK AND GOLD BOWS SEE PAGE 23

## Scissors

Straight



### Blunt/blunt

Code	Description
SC-GI/133	130mm long
SC-GI/136	146mm long
SC-GI/139	165mm long

### Sharp/blunt

Code	Description
SC-GI/134	130mm long
SC-GI/137	146mm long
SC-GI/140	165mm long

### Sharp/sharp

Code	Description
SC-PM/034	130mm long
SC-PM/035	146mm long
SC-PM/036	165mm long

## Dissecting Scissors

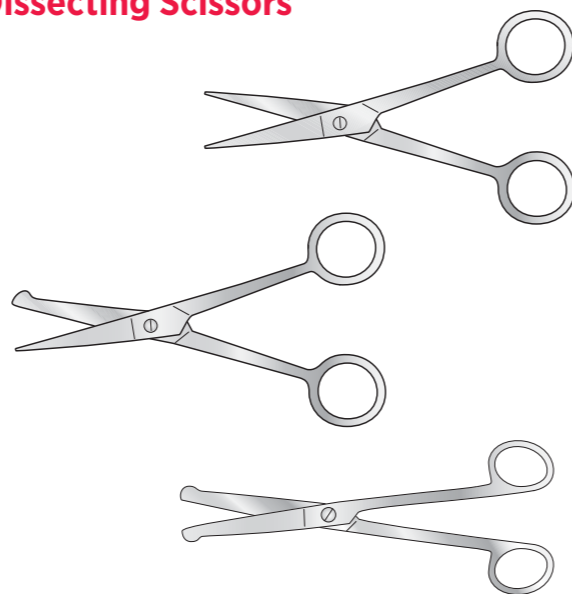

### Sharp/sharp

Code	Description
SC-PM/046	127mm long

### Sharp/probe

Code	Description
SC-PM/048	100mm long
SC-PM/047	127mm long
SC-PM/052	203mm long
SC-PM/052a	180mm long

### Probe/probe

Code	Description
SC-PM/050	127mm long
SC-PM/053	203mm long

## Scissors - Mayo

Straight, round point

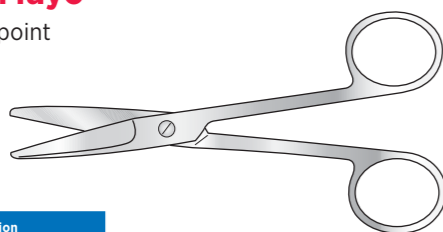

Code	Description
SC-GI/409	140mm long
SC-GI/409a	160mm long
SC-GI/411	215mm long

## Dressing Scissors

Fine end, tungsten carbide, supercut, 200mm long

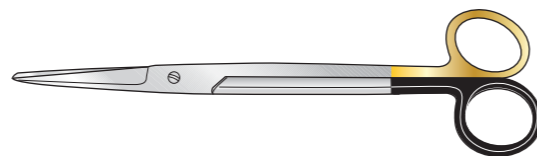

Code	Description
SC-PM/147	Blunt/sharp
SC-PM/149	Blunt/blunt

## Scissors - Mayo

Fine point

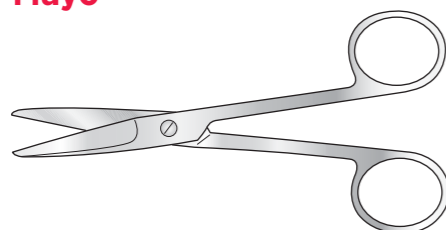

Code	Description
SC-PM/039	Straight 139mm long
SC-PM/043	Curved 139mm long
SC-PM/044	Curved 190mm long
SC-PM/045	Curved 215mm long

## Artery Scissors

Small, for all arteries, tungsten carbide, supercut, 100mm long

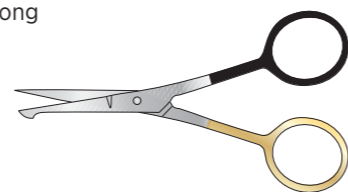

Code	Description
SC-PM/160	Sharp/probe

FOR INFORMATION ON BLACK AND GOLD BOWS SEE PAGE 23

# Scissors

## Dissection Scissors

Tungsten carbide, supercut, 175mm long

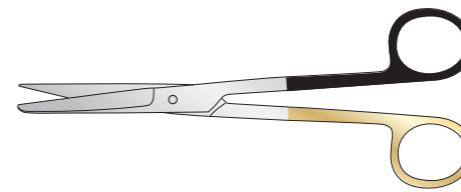

Code	Description
SC-PM/150	Blunt/blunt

## Mayo Dissection Scissors

Tungsten carbide, supercut, for soft tissue, 175mm long

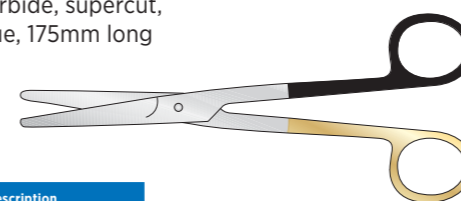

Code	Description
SC-PM/151	Sharp/blunt

## Bowel Scissors

Tungsten carbide, supercut, for dissection, straight, 180mm long

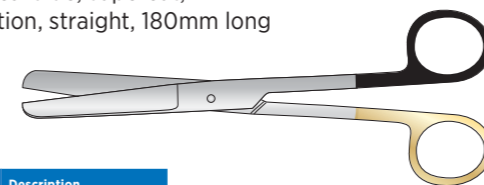

Code	Description
SC-PM/146	Blunt/blunt

## Scissors

Heavy

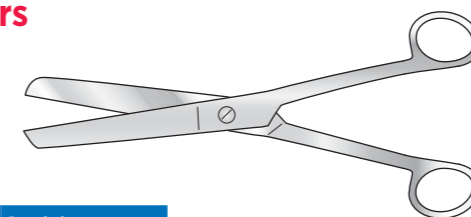

Code	Description
SC-PM/054	152mm long
SC-PM/055	177mm long

## Bowel Scissors

Guarded point, straight

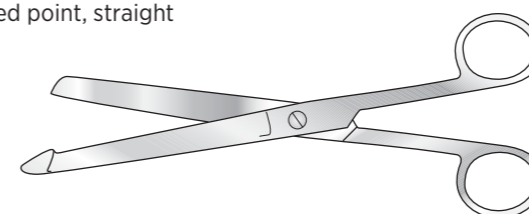

Code	Description
SC-PM/057	196mm long

## Barnards Bowel Scissors

Guarded point, straight

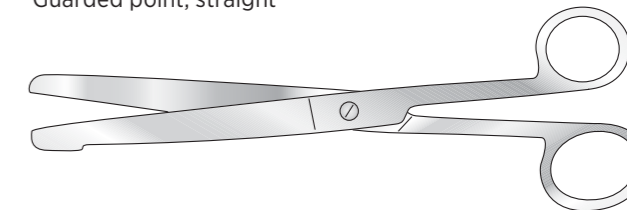

Code	Description
SC-PM/056	279mm long

## Iris scissors

102mm long

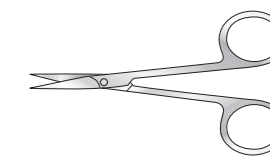

Code	Description
SC-OP/032	Straight
SC-OP/033	Curved

## Strabismus Scissors

114mm long

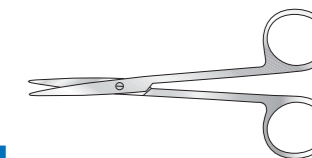

Code	Description
SC-OP/29	Straight
SC-OP/30	Curved

## Metzenbaum Scissors

185mm long

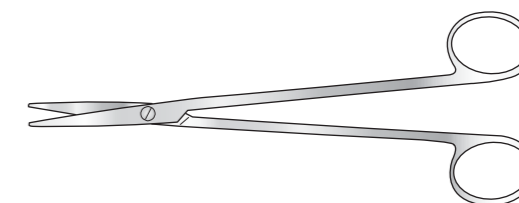

Code	Description
SC-GI/405	Straight
SC-GI/407	Curved

# Bone Cutting Forceps

## Liston Bone Cutting Forceps

Straight

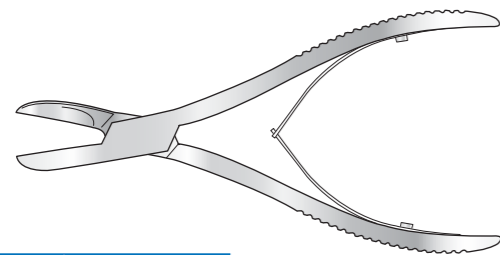

Code	Description
SC-OR/032	200mm long
SC-OR/027	220mm long
SC-PM/066	254mm long

## Ferguson "Lion" Bone Holding Forceps

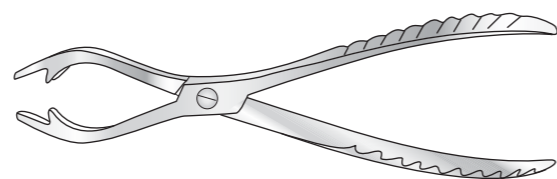

Code	Description
SC-PM/069	203mm long

## Horsley Bone Cutter

Compound action  
266mm long

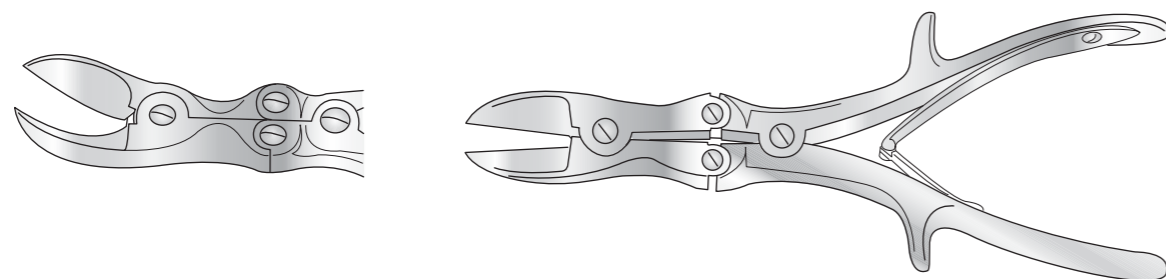

Code	Description
SC-PM/074	Straight
SC-PM/075	Angled

## Liston Bone Cutting Forceps

Angled

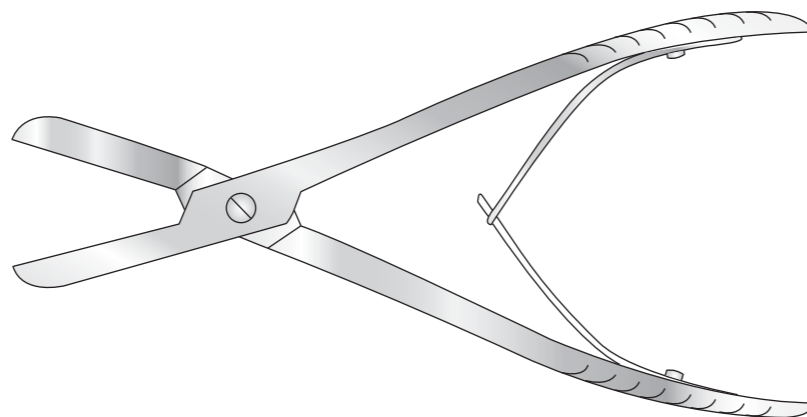

Code	Description
SC-PM/067	254mm long
SC-PM/068	304mm long

# Rib Shears

## Rib Shears

London Hospital pattern

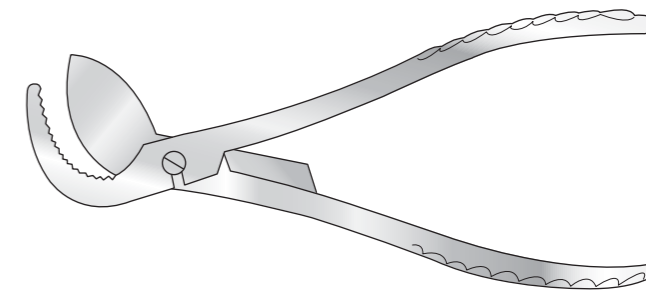

Code	Description
SC-PM/070	241mm long

## Pollock Rib Shears

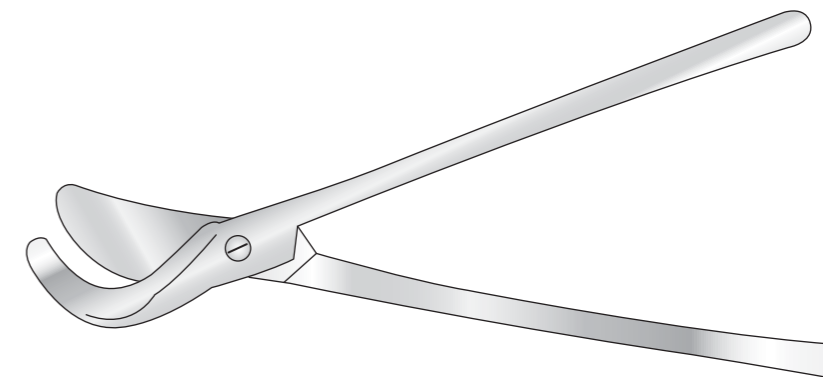

Code	Description
SC-PM/071	311mm long

## Rib Shears

Surgical Holdings pattern

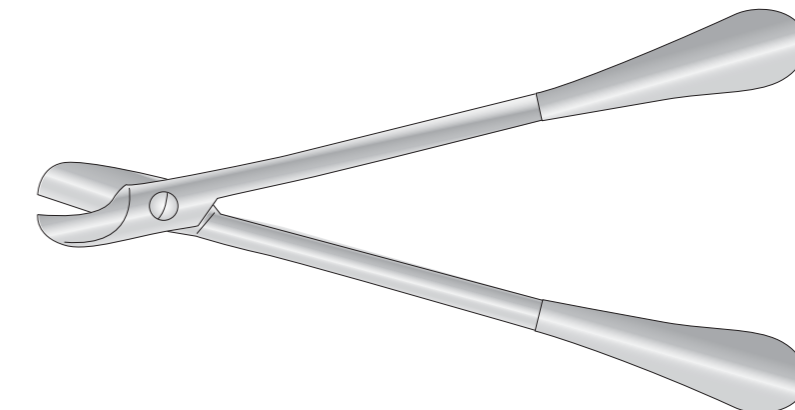

Code	Description
SC-PM/073a	387mm long

## Eslander Rib Shears

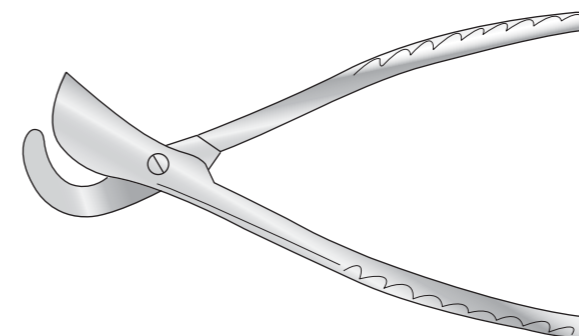

Code	Description
SC-PM/072	215mm long

## Infant Skull Shears

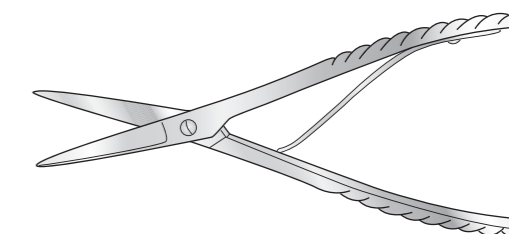

Code	Description
SC-PM/073	184mm long

# Dissecting Forceps and Needle Holder

## Dissecting Forceps

Serrated, turn over end

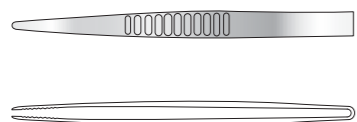

Code	Description
SC-GI/244	178mm long

## Block End Dissecting Forceps

Straight, serrated

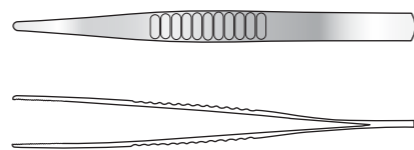

Code	Description
SC-GI/256	152mm long
SC-GI/256a	203mm long
SC-PM/080	254mm long
SC-PM/081	310mm long

## Treves Dissecting Forceps

200mm long

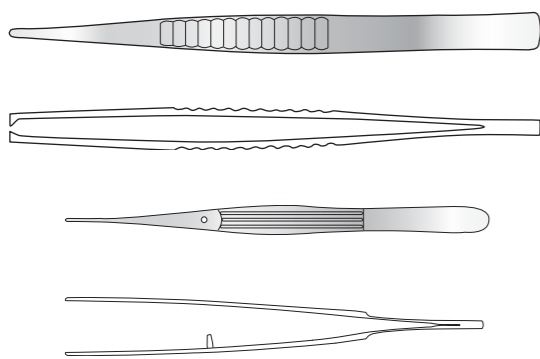

Code	Description
SC-PM/084	1-2 teeth
SC-PM/086	2-3 teeth

## Jean Dissecting Forceps

177mm long

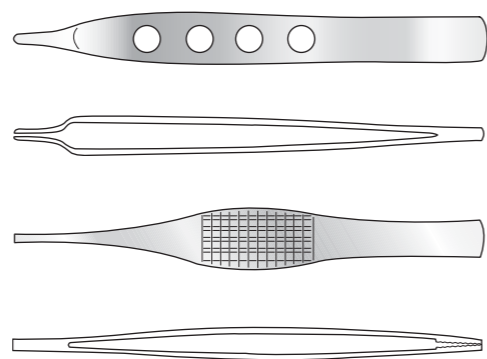

Code	Description
SC-PM/097	Serrated
SC-PM/098	1-2 teeth



## McIndoe Dissecting Forceps

152mm long

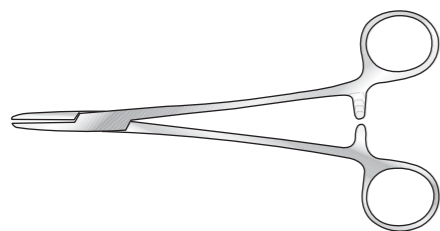

Code	Description
SC-GI/476	Serrated
SC-GI/477	1-2 teeth

## Ramsey Dissecting Forceps

177mm long

Code	Description
SC-PM/101	Serrated
SC-PM/102	1-2 teeth
SC-PM/103	2-3 teeth

## Mayo Hegar Needle Holder

Code	Description
SC-GI/244	159mm long
SC-PM/36c	178mm long
SC-GI/398	203mm long

# Forceps, Clamps and Raspatory

## Spencer Wells Artery Forceps

Straight

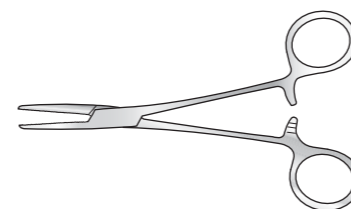

Code	Description
SC-GI/035	127mm long
SC-GI/036	152mm long
SC-GI/037	177mm long
SC-GI/038	203mm long

## Spencer Wells Artery Forceps

Curved

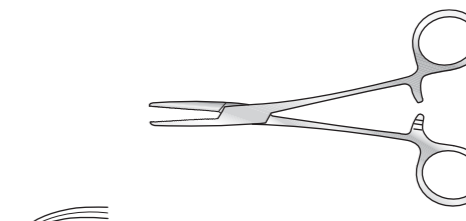

Code	Description
SC-GI/039	127mm long
SC-GI/040	152mm long
SC-GI/041	177mm long
SC-GI/042	203mm long

## Dura Mater Stripping Forceps

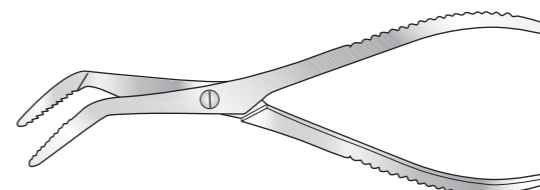

Code	Description
SC-PM/091	203mm long

## Lane Bowel Clamp

Stainless steel, straight

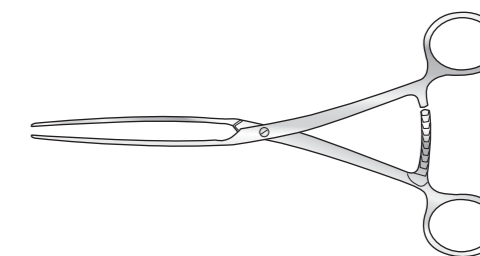

Code	Description
SC-PM/087	177mm long

## Raspatory

For scalp

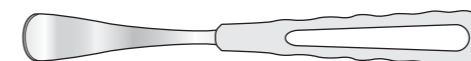

Code	Description
SC-PM/090	175mm long

# Saws

## Fixed Back Saw

14 teeth per inch

Code	Description
SC-PM/105	Blade length 228mm
SC-PM/107	Blade length 254mm

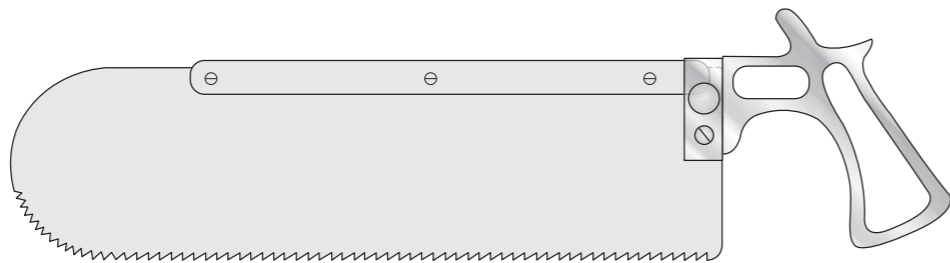

## Barnard's Saw

14 teeth per inch

Code	Description
SC-PM/104	Blade length 279mm

## Hinged Back Saw

14 teeth per inch

Code	Description
SC-PM/106	Blade length 228mm
SC-PM/108	Blade length 254mm

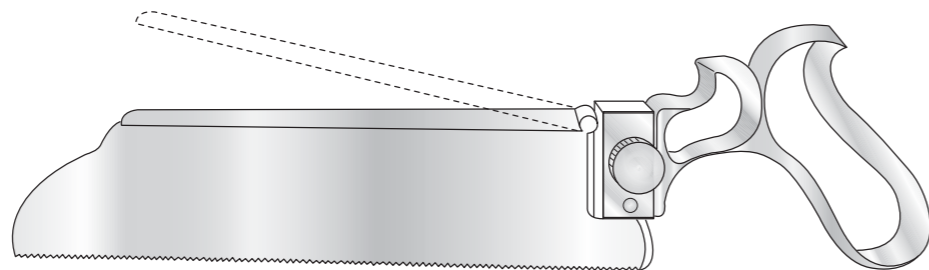

## Spinal Saw

Fixed back, double bladed, adjustable

Code	Description
SC-PM/109	Blade length 152mm, 297mm long

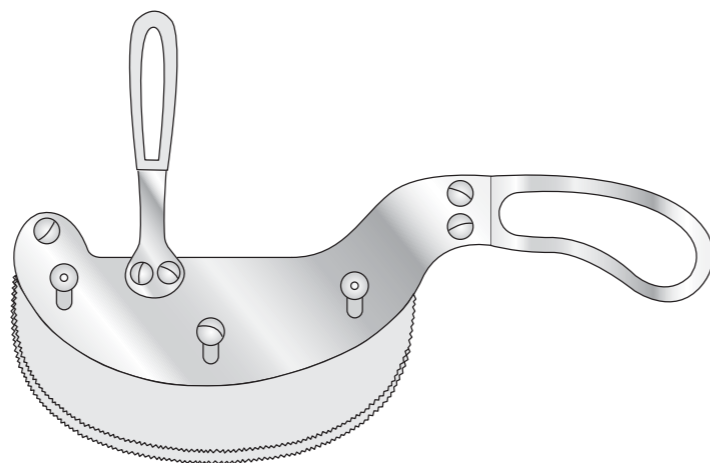

## Amputation Saw

Fixed back, with shaped end

Code	Description
SC-PM/110	Blade length 254mm

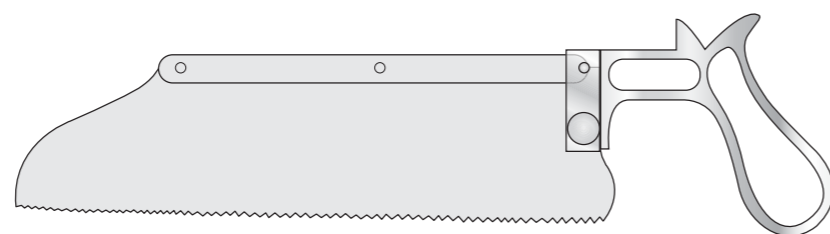

# Gouges and Chisels

## Gouge

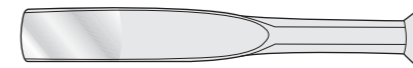

Code	Description
SC-PM/133	Blade 19mm

## Chisel

Straight

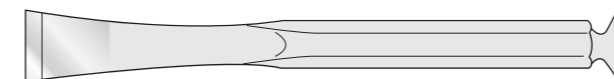

Code	Description
SC-PM/130	Blade 12mm
SC-PM/131	Blade 19mm
SC-PM/132	Blade 25mm

## Spinal Chisel

With locating point

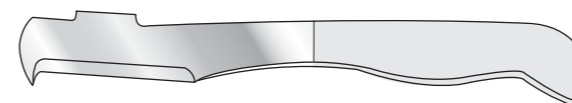

Code	Description
SC-PM/135	180mm

## Chisel

T shaped

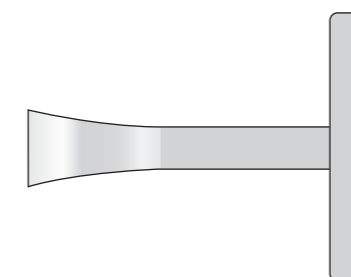

Code	Description
SC-PM/137	23mm blade, 100mm long
SC-PM/138	25mm blade, 127mm long

## Vertebrae Chisel

Angled

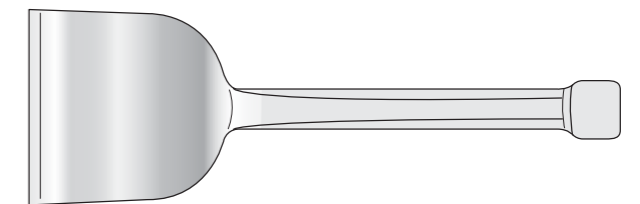

Code	Description
SC-PM/136	Blade 76mm

## Vertebrae/Bone Chisel

Angled, with blue acetic "Suregrip" handles

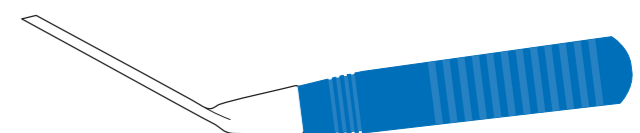
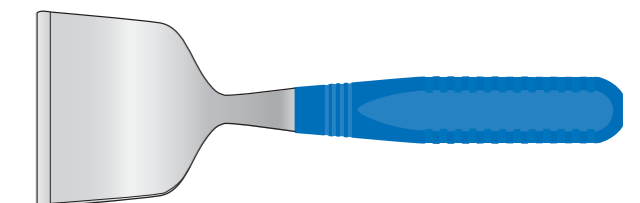

Code	Description
SC-PM/136BH	Blade 76mm

# Mallets, Probes, Retractors, Needles

## Rubber Mallet

With wooden handle  
305mm long



Code	Description
SC-PM/142	300 grams

## Mallet

Army pattern, lead filled

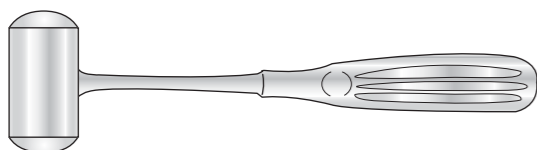

Code	Description
SC-PM/141	200mm long

## Hammer

Wrench end

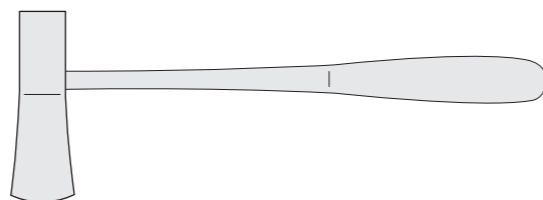

Code	Description
SC-PM/140	200mm long

## Silver Plated Probe

With eye



Code	Description
SC-GI/289	152cm long
SC-GI/291	203mm long
SC-GI/292	255mm long

## Silver Probe

Fish tail



Code	Description
SC-GI/294	152cm long
SC-GI/295	203mm long
SC-GI/296	255mm long

## Durham Retractor

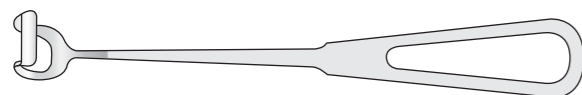

Code	Description
SC-PM/121	215mm long

## Scalpel Blade Remover

Serrated

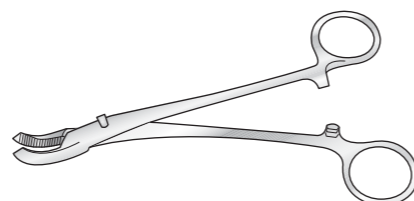

Code	Description
SC-PM/128	148mm long



# Proctology

Forceps	206
Clamps	207
Scissors	208
Directors	208
Retractors	209
Proctoscopes	209
Sponge Holder	210

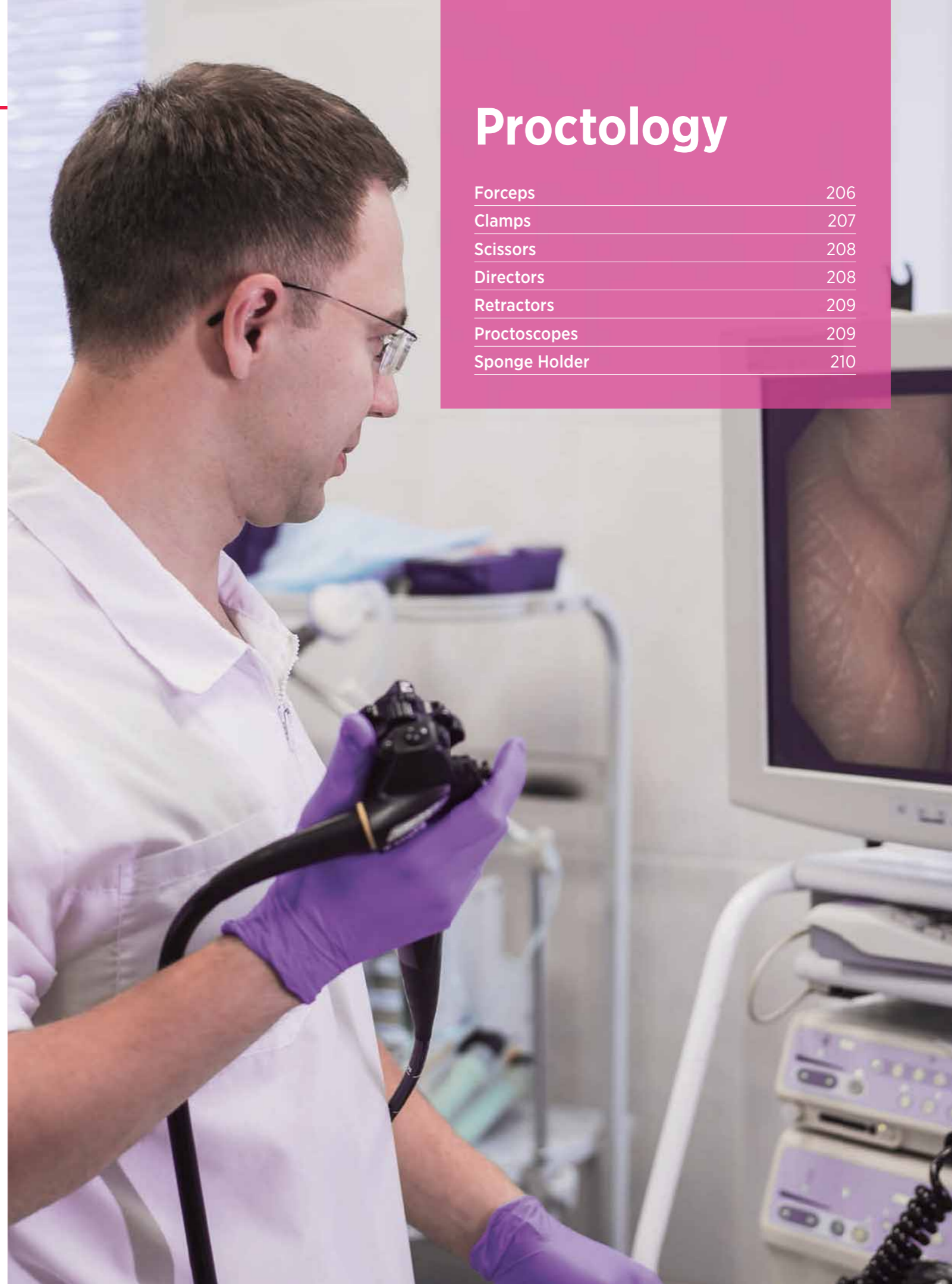

# Forceps

## Officer Biopsy Forceps

With 8mm cup jaw, to use through a sigmoidoscope

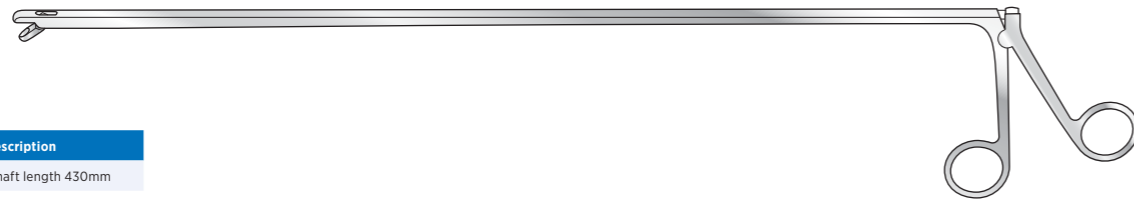

Code	Description
SC-PR/001	Shaft length 430mm

## Yeoman Basket

Jawed to use through a sigmoidoscope

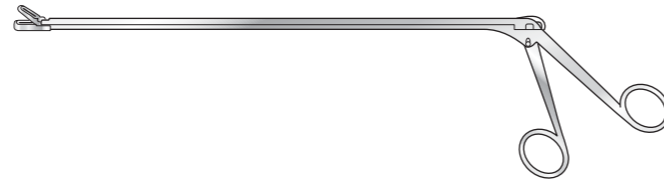

Code	Description
SC-PR/002a	Shaft length 250mm
SC-PR/002b	Shaft length 355mm
SC-PR/002c	Shaft length 430mm

## Lloyd-Davis Sigmoidoscope

Biopsy forceps

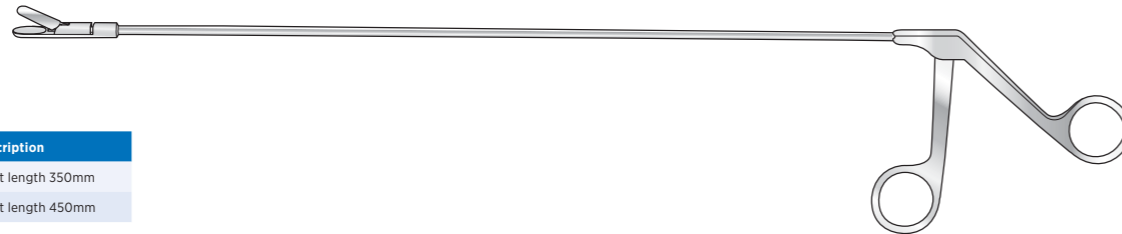

Code	Description
SC-PR/020a	Shaft length 350mm
SC-PR/020b	Shaft length 450mm

## Walton Rectal Biopsy Forceps

With laterally angled shanks

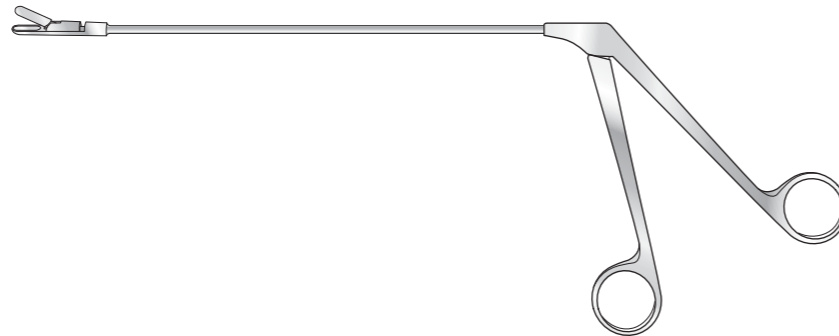

Code	Description
SC-PR/022	Shaft length 203mm

## Officer Dissecting Forceps



Code	Description
SC-PR/008a	2-3 fine teeth, 150mm long
SC-PR/008b	2-3 fine teeth, 200mm long

Code	Description
SC-PR/008c	4-5 fine teeth, 200mm long
SC-PR/008d	4-5 fine teeth, 250mm long

# Forceps and Clamps

## Lloyd-Davis Rectal Occlusion Forceps

With longitudinal serrations

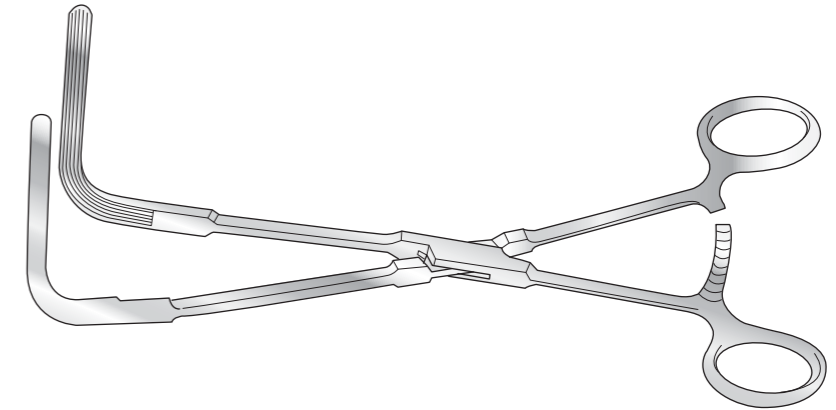

Code	Description
SC-PR/023	300mm long

## Finch Excision Clamp

With hollowed jaws

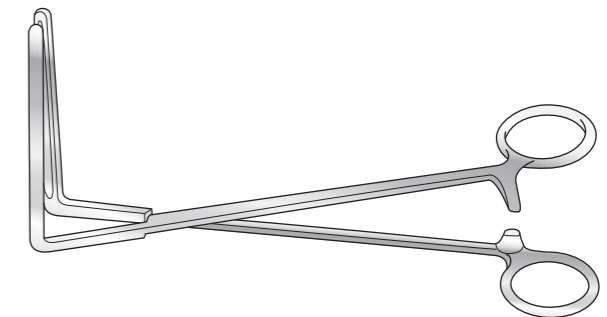

Code	Description
SC-PR/003	75mm blade, 215mm long

## Hays Colon Resection Clamp

Angled at 70°

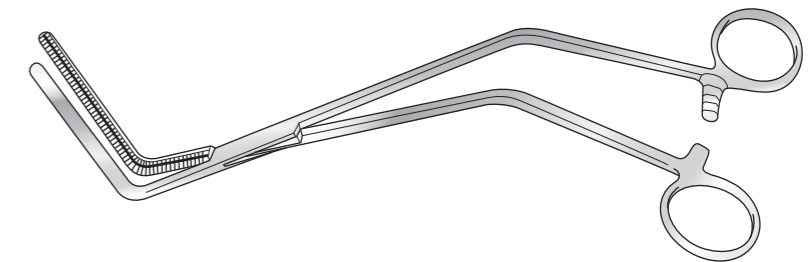

Code	Description
SC-PR/004a	Jaw length 80mm 270mm long
SC-PR/004	Jaw length 100mm 285mm long



# Scissors and Directors

## Abel Abdominal-Perineal Scissors

Straight

Code	Description
SC-PR/016	320mm long

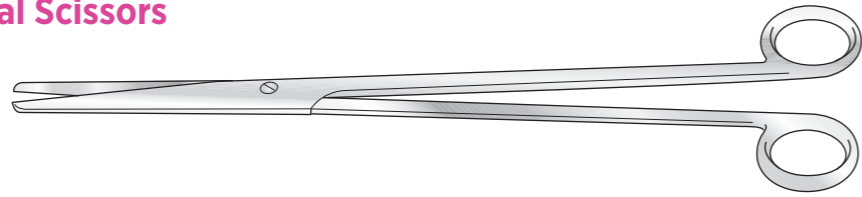

## Goligher Scissors

Straight

Code	Description
SC-PR/017a	300mm long
SC-PR/017b	330mm long

Curved

Code	Description
SC-PR/017c	300mm long
SC-PR/017d	330mm long

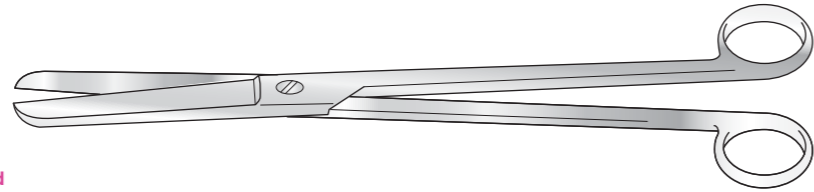

## Lloyd-Davis Rectal Scissors

Flattened blades, blunt points  
265mm long

Code	Description
SC-PR/018a	Straight
SC-PR/018b	Curved on flat

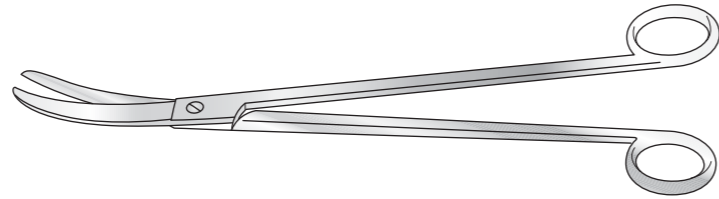

## St Mark's Rectal Dilator

Code	Description
SC-PR/005a	Small, 14mm x 19mm
SC-PR/005b	Large, 16mm x 25mm



## Lockhart Mummery Fistula Director

165mm long

Straight

Code	Description
SC-PR/006a1	With 1mm hole



90° curve

Code	Description
SC-PR/006c1	With 1mm hole



45° curve

Code	Description
SC-PR/006b	With 1mm hole



Retrograde

Code	Description
SC-PR/006d1	With 1mm hole



# Retractors and Proctoscopes

## Lloyd-Davis Retractor

Code	Description
SC-PR/013a	Short, without tapered end, 125mm x 55mm
SC-PR/013b	Long, with tapered end, 170mm x 65mm x 50mm

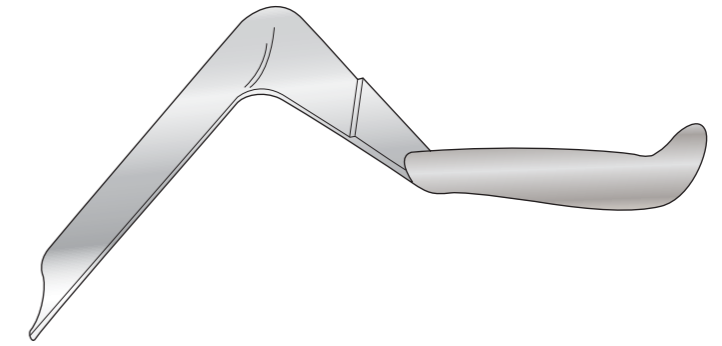

## Park Combined Anal Retractor

Self retaining, with 2 sets of interchangeable blades and one adjustable centre blade

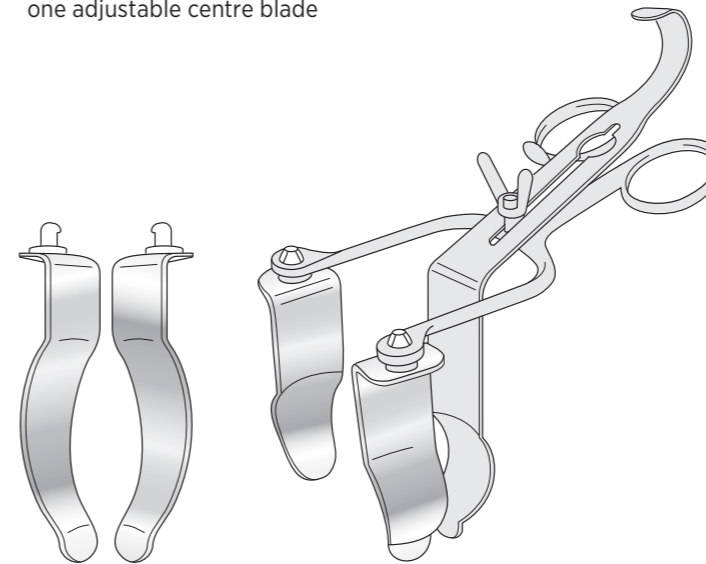

Code	Description
SC-PR/015	140mm long

## Park Anal Retractor

Self retaining

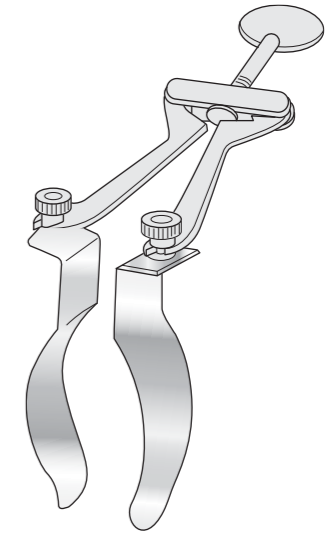

Code	Description
SC-PR/014	130mm, 95mm

## Kelly Proctoscope

With obturator, lumen

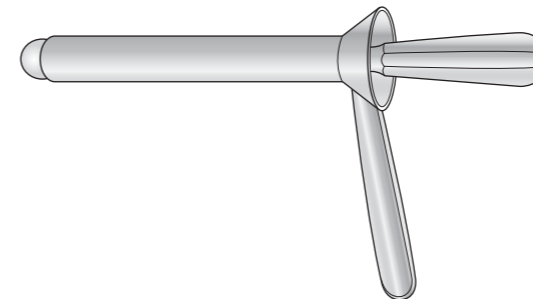

Code	Description
SC-PR/012a	140mm long
SC-PR/012b	200mm long
SC-PR/012c	Tapered, 22mm ø, x 100mm

## Eisenhammer Speculum

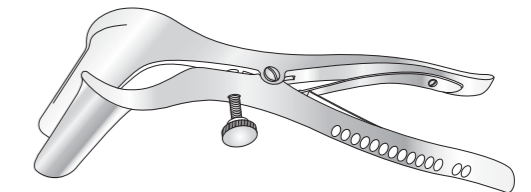

Code	Description
SC-SH/4120	Blade 70mm long x 20mm wide
SC-SH/41201	Blade 95mm long x 20mm wide

## Sponge Holder

### Sponge Holder

With spring handle

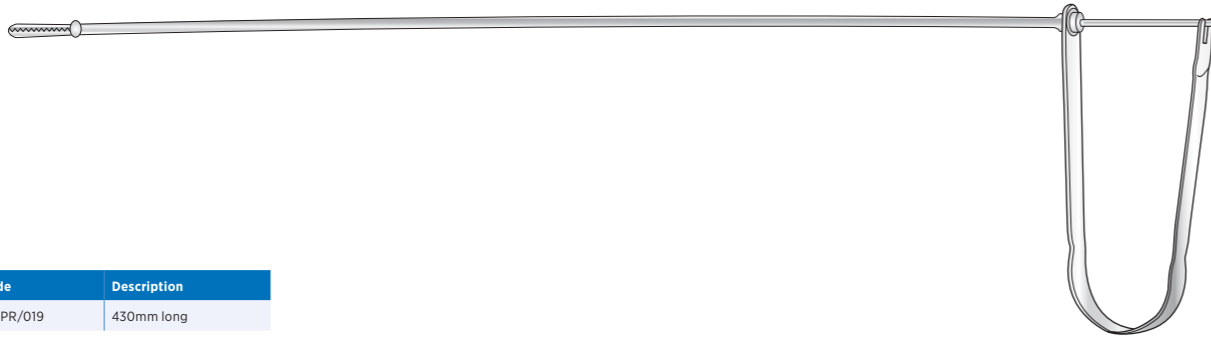

Code	Description
SC-PR/019	430mm long

## Thoracic

Artery Clamps	212
Clamps	214
Bulldog Clamps	219
Scissors	220
Needle Holders	221
Retractors	222
Rib Spreaders	223
Rib Shears	226
Lung Forceps	226
Elevators	227
Miscellaneous	227



## An Overview On Atraumatic Jaws

Also known as non-traumatic, atraumatic jaws will be mainly found in delicate surgery areas such as vascular and cardiothoracic. The design is such, that the surface area gripped is reduced, ensuring less trauma without the loss of grip.

Atraumatic jaws are available as straight or curved.

### Atraumatic Jaw, Straight



### Atraumatic Jaw, Curved



## Cooley Artery Clamps

Box joint, atraumatic, curved

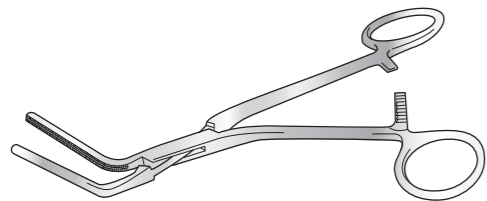

Code	Description
SC-GI/071	160mm long
SC-GI/072	200mm long

Large, strongly curved 90°

Code	Description
SC-GI/074	140mm long

Large, curved 60°

Code	Description
SC-GI/073	150mm long

Curved 30°

Code	Description
SC-GI/075	160mm long

## DeBakey Bainbridge Clamps

Box joint, atraumatic, haemostatic

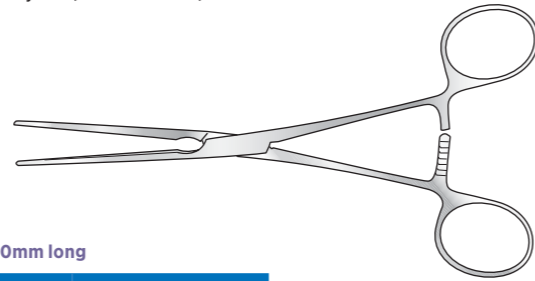

180mm long

Code	Description
SC-GI/078	Straight
SC-GI/077	Curved

## DeBakey Bainbridge Clamps

Box joint, atraumatic

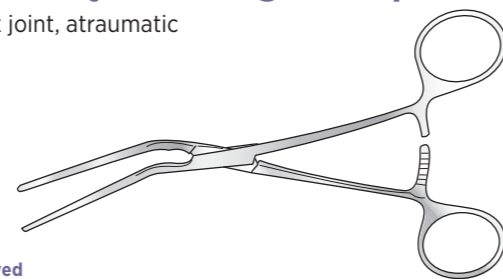

Curved

Code	Description
SC-GI/079	165mm long

## DeBakey Bainbridge Clamps

Box joint, atraumatic, haemostatic

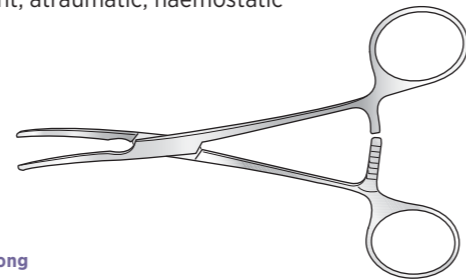

155mm long

Code	Description
SC-GI/105	Curved
SC-GI/106	Straight

## DeBakey Clamps

Box joint, atraumatic

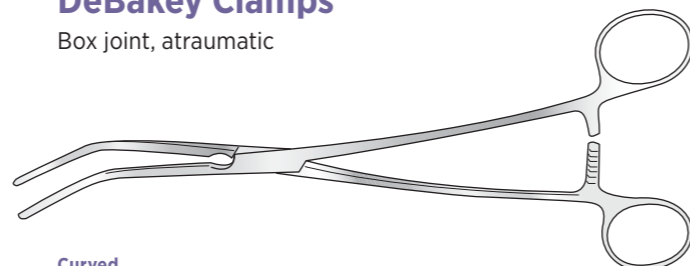

Curved

Code	Description
SC-GI/086	230mm long

## DeBakey Clamps

Box joint, atraumatic

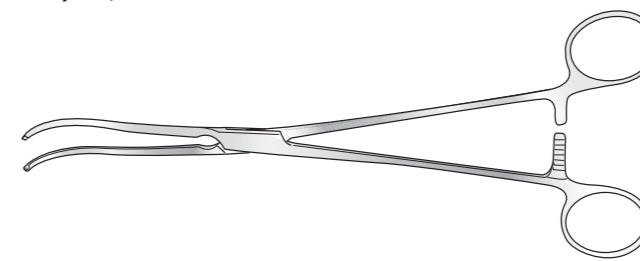

Curved

Code	Description
SC-GI/088	230mm long
SC-GI/089	240mm long
SC-GI/090	245mm long

## DeBakey Clamps

Box joint, atraumatic

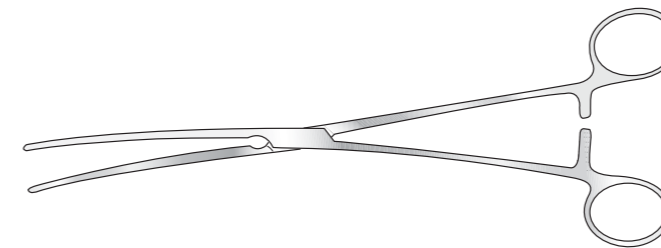

Curved

Code	Description
SC-GI/091	250mm long
SC-GI/092	270mm long
SC-GI/093	280mm long

## DeBakey Clamps

Box joint, atraumatic, straight

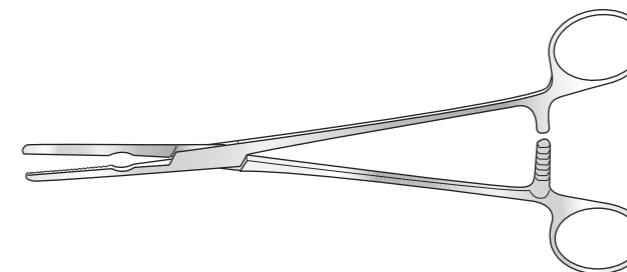

Curved

Code	Description
SC-GI/100	160mm long
SC-GI/104	165mm long
SC-GI/101	203mm long
SC-GI/098	215mm long
SC-GI/102	220mm long
SC-GI/103	230mm long
SC-GI/099	245mm long

## DeBakey Clamps

Box joint, atraumatic

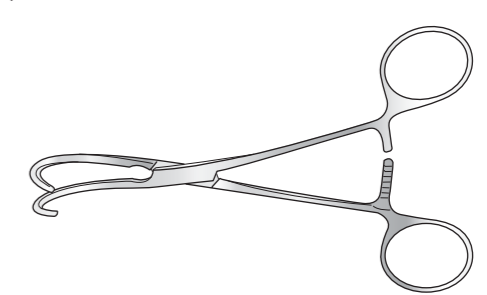

Curved

Code	Description
SC-GI/094	150mm long

## DeBakey Clamps

Box joint, atraumatic

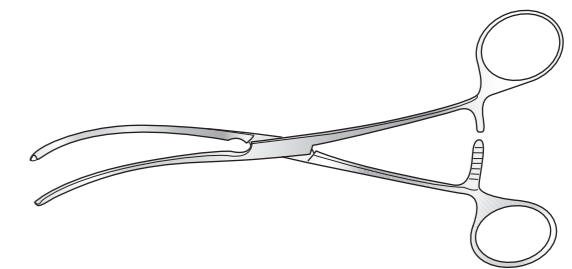

Curved

Code	Description
SC-GI/096	180mm long
SC-GI/097	203mm long

## DeBakey Clamps

Box joint, atraumatic

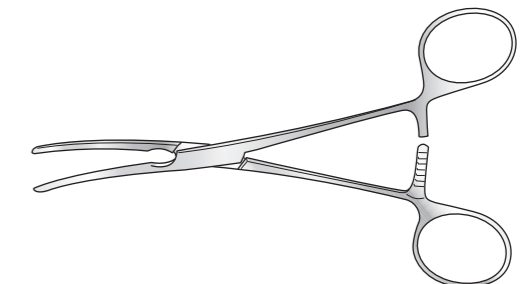

Curved

Code	Description
SC-GI/080	165mm long
SC-GI/081	190mm long
SC-GI/082	203mm long
SC-GI/083	215mm long
SC-GI/084	220mm long

**Duval Lung Grasping Clamps**

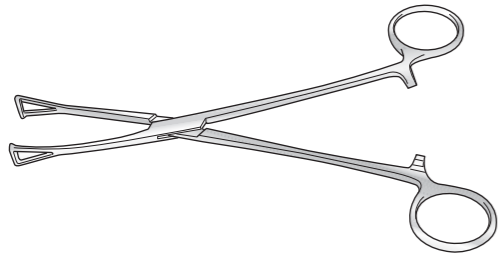

Code	Description
SC-THO/033	185mm long

**Tudor Edwards Artery Clamps**

Curved, serrated jaws, screw joint, satin finish

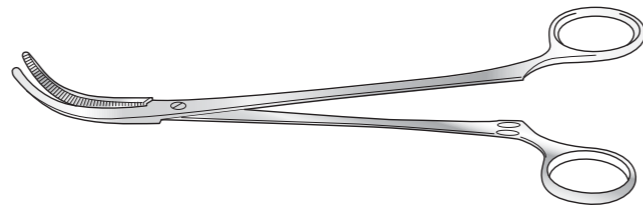

Code	Description
SC-THO/015	230mm long

**Babcock Lung Grasping Clamps**

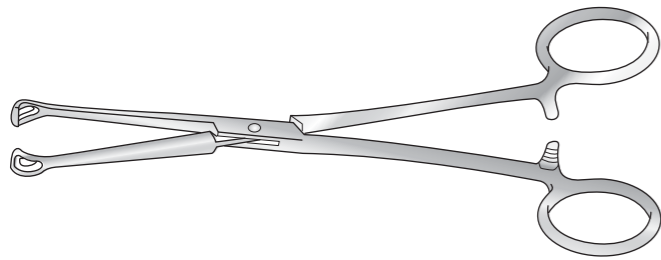

Code	Description
SC-THO/034	245mm long

**O'Shaughnessy Artery Clamps**

Right angled serrated jaw

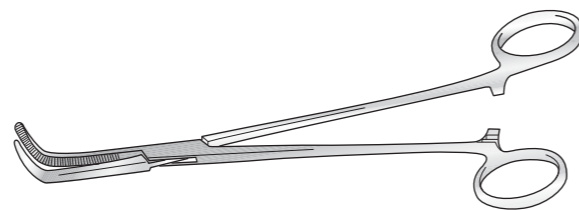

Code	Description
SC-THO/036a	150mm long
SC-THO/036b	180mm long
SC-THO/036c	200mm long
SC-THO/036d	230mm long

**DeBakey Atraumatic Dissecting Clamps**

Straight, atraumatic jaws

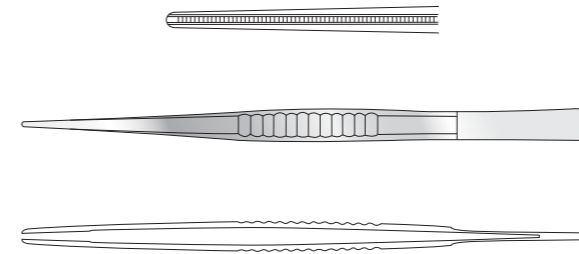

**1.5mm**

Code	Description
SC-GI/238a	150mm long
SC-GI/240a	240mm long

**2mm**

Code	Description
SC-GI/238	150mm long
SC-GI/241	180mm long

**2.5mm**

Code	Description
SC-GI/238b	150mm long
SC-GI/240b	240mm long

**2.8mm**

Code	Description
SC-GI/238c	150mm long
SC-GI/240c	240mm long
SC-GI/241c	180mm long

**Magill Intratracheal Catheter Clamps**

Screw joint

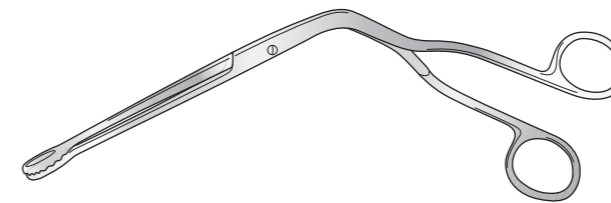

Code	Description
SC-THO/032	Infant, 160mm long
SC-THO/032a	Child, 190mm long
SC-THO/032b	Adult, 230mm long

**SEMB Ligature Passing Clamps**

240mm long

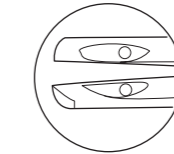
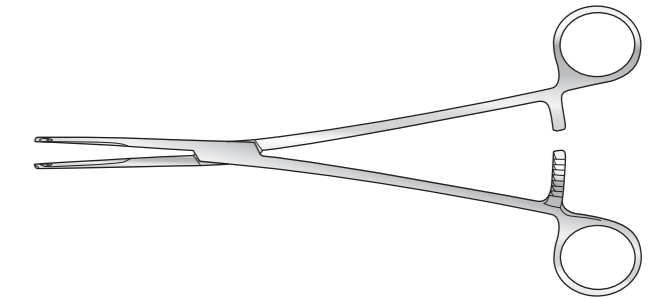

Code	Description
SC-THO/044	Slightly curved
SC-THO/045	Fully curved

**Lambert-Kay Clamp**

Atraumatic

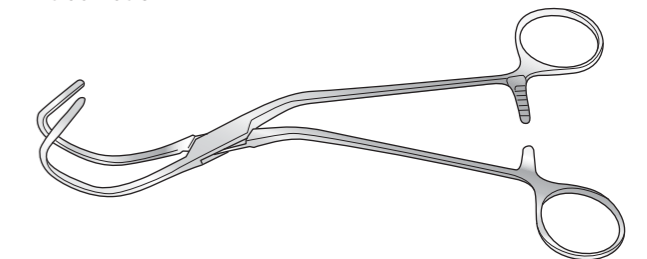

Code	Description
SC-THO/029a	Curved, 220mm long
SC-THO/029b	Straight, 215mm long
SC-THO/029c	Straight, 200mm long

**Leland-Jones Clamp**

Atraumatic, hemostatic

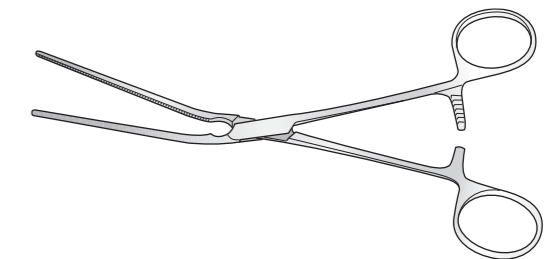

Code	Description
SC-THO/023a	Curved, 190mm long
SC-THO/023b	Straight, 195mm long

**Surgical Holdings now offer a VATS range of instruments through Reuchlen**

Order now by emailing [info@surgicalholdings.co.uk](mailto:info@surgicalholdings.co.uk)



**DeBakey Clamp**  
Straight jaws, ring handle

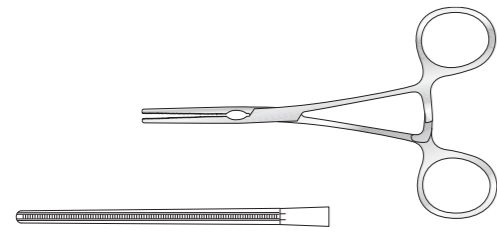

Code	Description
SC-THO/048	137mm long

**DeBakey Clamp**  
'S' shaped curved jaws, curved shaft, ring handle

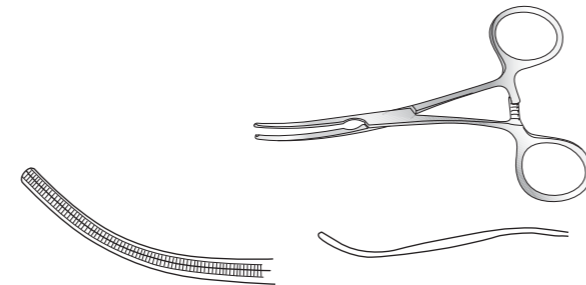

Code	Description
SC-THO/049	127mm long

**DeBakey "S" Shaped Clamp**  
300mm long

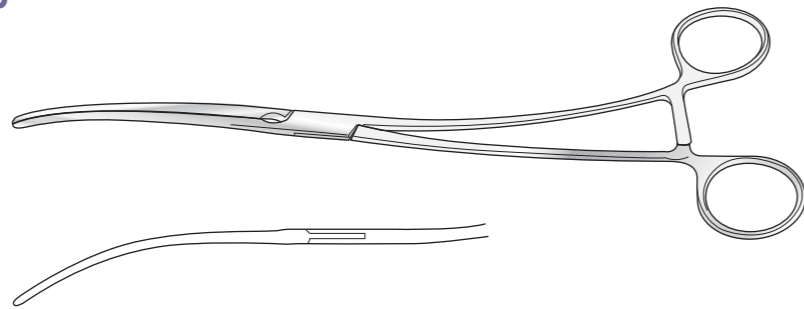

Code	Description
SC-THO/096	115mm jaws

**DeBakey Atraumatic Clamp**

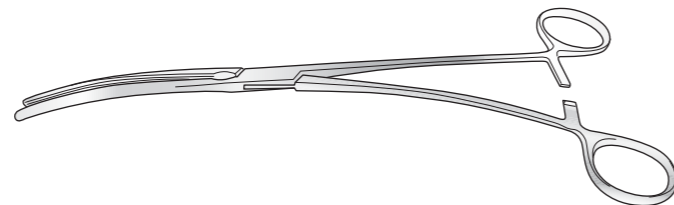

Code	Description
SC-THO/090	110mm jaw, 300mm long
SC-THO/092	95mm jaw, 250mm long

**DeBakey Atraumatic Clamp**  
Right-angled, 40mm jaw

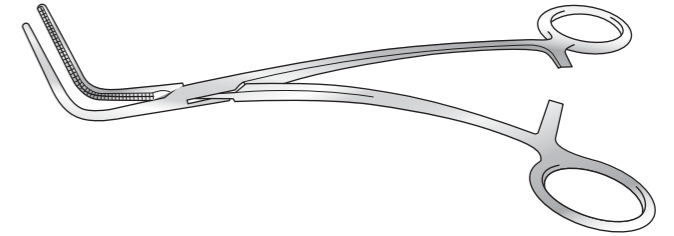

Code	Description
SC-THO/044a	220mm long

**DeBakey Atraumatic Clamp**  
Right-angled, 50mm jaw

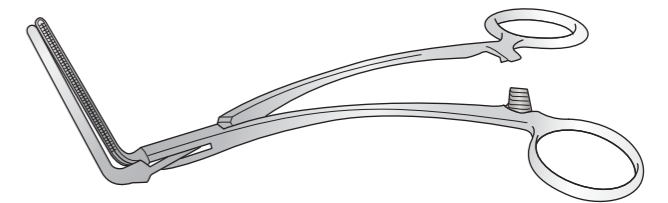

Code	Description
SC-THO/045	200mm long

**DeBakey Atraumatic Clamp**  
Right-angled, 65mm jaw

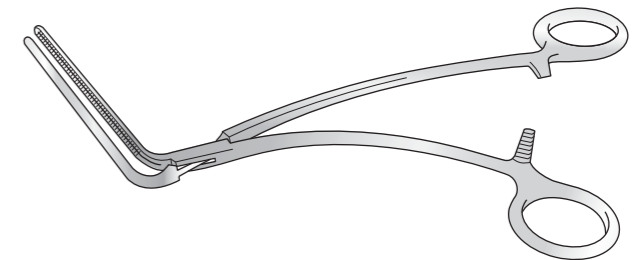

Code	Description
SC-THO/046	215mm long

**DeBakey Atraumatic Clamp**  
Right-angled, 100mm jaw

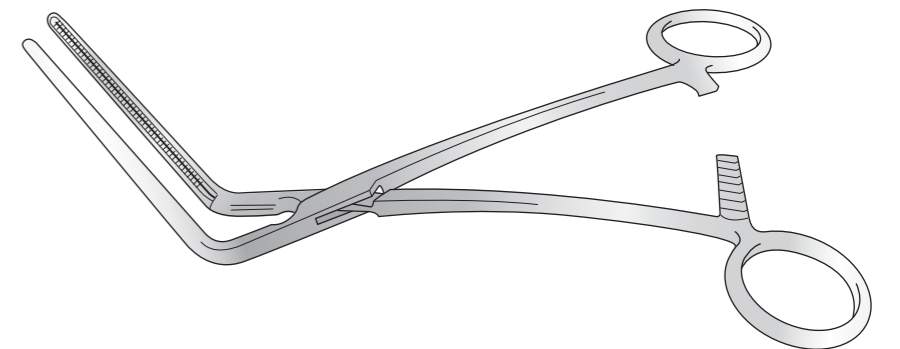

Code	Description
SC-THO/047	280mm long

# Clamps

## DeBakey Coarctation Clamp

Angled, 225mm long

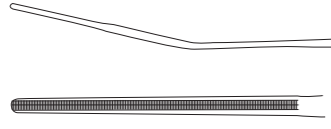

Code  
SC-THO/052

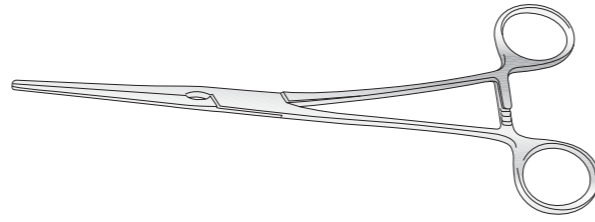

## DeBakey Multipurpose Clamp

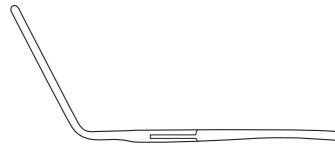

Code	Description
SC-THO/095	85mm jaw, 230mm long
SC-THO/064	100mm jaw, 280mm long

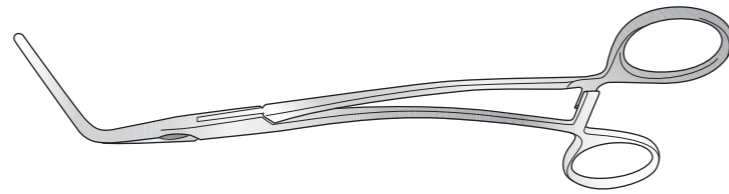

## DeBakey Multipurpose Clamp

Obtuse angled 60°, 280mm long

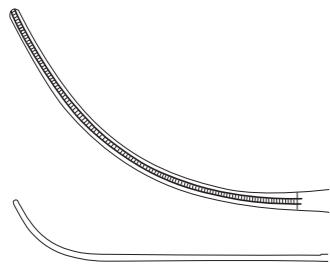

Code  
SC-THO/053

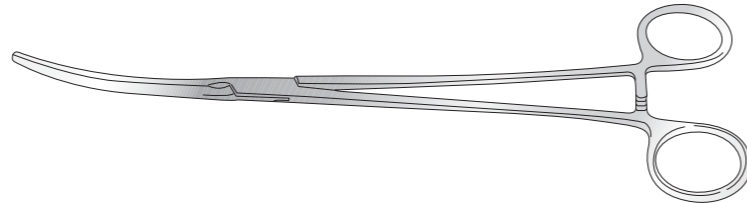

## DeBakey 45° Paediatric Clamp

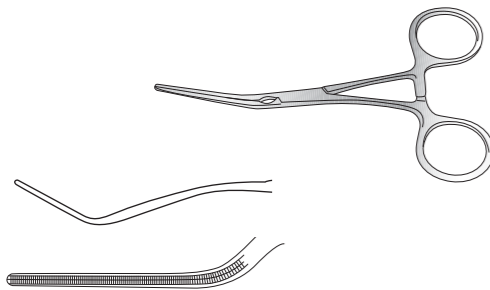

Code	Description
SC-THO/050	130mm long

## DeBakey 90° Paediatric Clamp

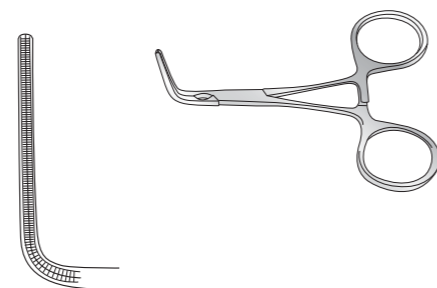

Code	Description
SC-THO/051	105mm long

# Bulldog Clamps

## Dieffenbach Bulldog Clamp

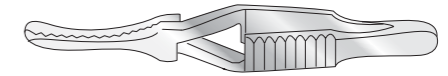
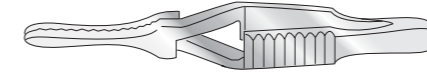

### Straight, serrated

Code	Description
SC-GI/112	1.2mm fine jaw, 40mm long
SC-GI/113	1.2mm fine jaw, 45mm long
SC-GI/108	1.8mm jaw, 30mm long
SC-GI/109	1.8mm jaw, 35mm long
SC-GI/110	2.5mm jaw, 40mm long
SC-GI/111	2.5mm jaw, 45mm long
SC-GI/107	6mm heavy jaw, 60mm long
SC-GI/455	20mm jaw, 75mm long
SC-GI/455a	30mm jaw, 85mm long
SC-GI/455b	45mm jaw, 105mm long
SC-GI/455c	65mm jaw, 120mm long

### Straight, plain

Code	Description
SC-GI/129	1.2mm fine jaw, 40mm long
SC-GI/131	1.2mm fine jaw, 45mm long
SC-GI/121	1.8mm jaw, 30mm long
SC-GI/123	1.8mm jaw, 35mm long
SC-GI/125	2.5mm jaw, 40mm long
SC-GI/127	2.5mm jaw, 45mm long

### Curved, serrated

Code	Description
SC-GI/119	1.2mm fine jaw, 40mm long
SC-GI/120	1.2mm fine jaw, 45mm long
SC-GI/115	1.8mm jaw, 30mm long
SC-GI/116	1.8mm jaw, 35mm long
SC-GI/117	2.5mm jaw, 40mm long
SC-GI/118	2.5mm jaw, 45mm long
SC-GI/114	6mm heavy jaw, 60mm long
SC-GI/456	20mm jaw, 75mm long
SC-GI/456a	30mm jaw, 85mm long
SC-GI/456b	45mm jaw, 105mm long
SC-GI/456c	65mm jaw, 120mm long

### Curved, plain

Code	Description
SC-GI/130	1.2mm fine jaw, 40mm long
SC-GI/132	1.2mm fine jaw, 45mm long
SC-GI/122	1.8mm jaw, 30mm long
SC-GI/124	1.8mm jaw, 35mm long
SC-GI/126	2.5mm jaw, 40mm long
SC-GI/128	2.5mm jaw, 45mm long

## Blalock Bulldog Clamp

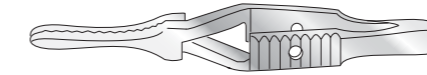

### Serrated, with hole in handle

#### Straight

Code	Description
SC-GI/480	11mm jaw, 38mm long
SC-GI/482	14mm jaw, 48mm long
SC-GI/493	17mm jaw, 60mm long
SC-GI/481	27mm jaw, 70mm long

#### Curved

Code	Description
SC-GI/478	11mm jaw, 38mm long
SC-GI/479	14mm jaw, 48mm long
SC-GI/491	17mm jaw, 60mm long
SC-GI/492	27mm jaw, 70mm long

### Plain, with hole in handle

#### Straight

Code	Description
SC-GI/486	11mm jaw, 38mm long
SC-GI/487	14mm jaw, 48mm long
SC-GI/488	17mm jaw, 60mm long
SC-GI/489	27mm jaw, 70mm long

#### Curved

Code	Description
SC-GI/483	11mm jaw, 38mm long
SC-GI/484	14mm jaw, 48mm long
SC-GI/485	17mm jaw, 60mm long
SC-GI/490	27mm jaw, 70mm long

## Diethrich Bulldog Clamp

Angled 12mm jaw

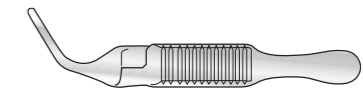

Code	Description
SC-JD-GI/8097	44mm long

# Scissors

FOR INFORMATION ON BLACK AND GOLD BOWS SEE PAGE 23

FOR INFORMATION ON BLACK AND GOLD BOWS SEE PAGE 23

# Needle Holders

## Potts Scissors

Satin finish, 190mm long

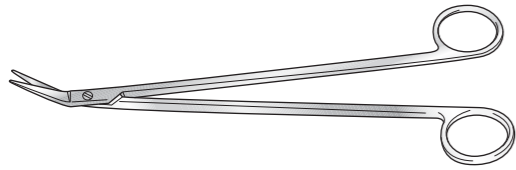

Code	Description
SC-THO/019	Angled on flat 45°
SC-THO/020a	Angled to side 45°
SC-THO/020b	Acute angle to side

## Potts Diethrich Scissors

Supercut, 190mm long

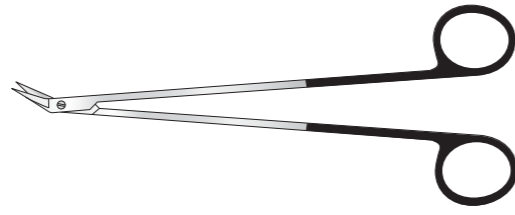

Code	Description
SC-THO/078	25° angled on side
SC-THO/079	45° angled on side
SC-THO/080	90° angled on side

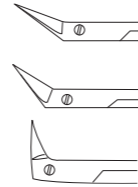

## Diethrich Circumflex Artery Scissors

Supercut, 175mm long

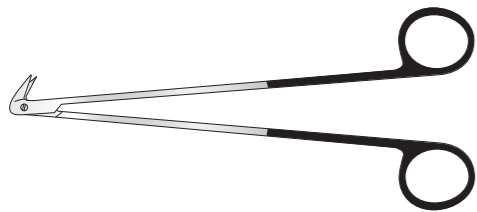

Code	Description
SC-THO/077	125° angled on side

## Boyd Scissor

Supercut, slight curve

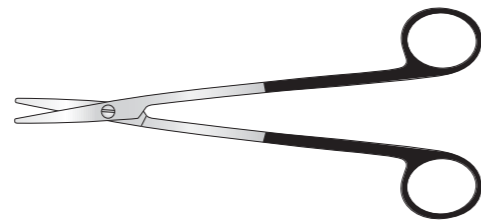

Code	Description
SC-THO/047	180mm long

## Lobectomy Scissors

Curved on flat

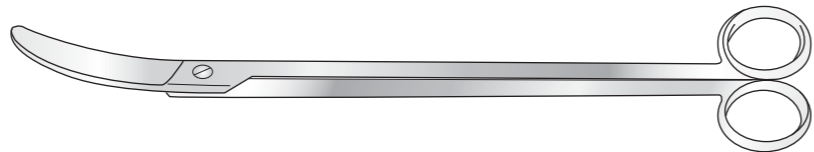

Code	Description
SC-THO/001b	305mm long

## Nelson Lobectomy Scissor

Tungsten carbide, curved on flat, 230mm long

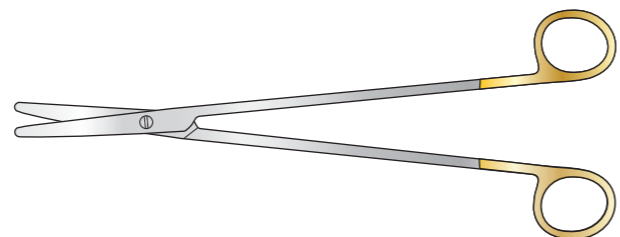

Code
SC-THO/057

## Needle Holder and Wire Twister

For sternum wire, left-handed, 300mm long

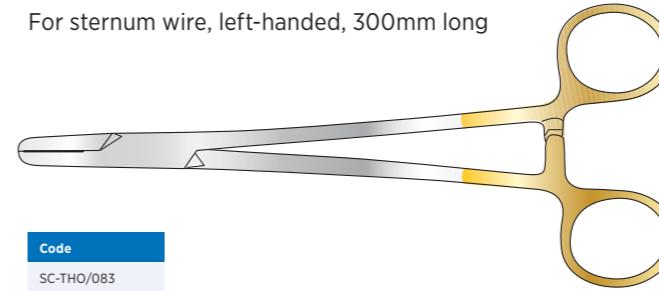

Code
SC-THO/083

## Rochester Needle Holder

Light, delicate model, with tungsten carbide jaws 190mm long

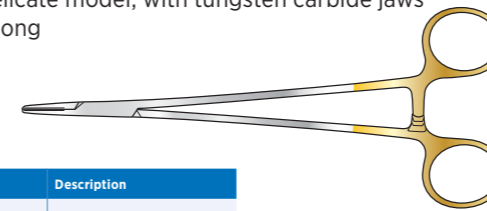

Code	Description
SC-THO/082	
SC-THO/082a	Left-handed

## Stratte Needle Holder

210mm long

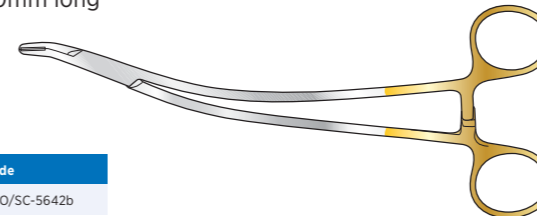

Code
THO/SC-5642b

## Julian Needle Holder

Light, delicate model, with tungsten carbide jaws 220mm long

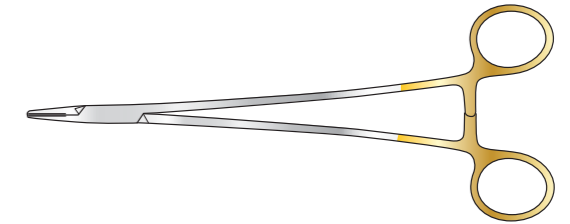

Code	Description
SC-THO/081	
SC-THO/081a	Left-handed

## DeBakey Needle Holder

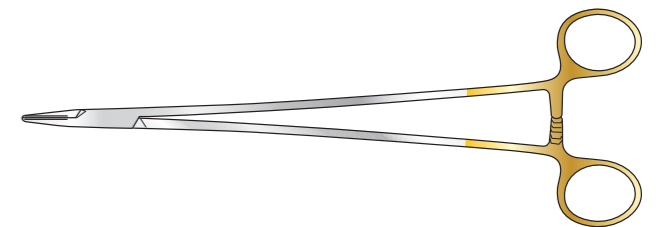

Code	Description
THO/SC-5642a	250mm long
SC-GI/502A	165mm very delicate
SC-GI/502	180mm tungsten carbide
SH003944	260mm long straight with tungsten carbide inserts
SC-5642A	240mm long
SC-GI/036BM	Tungsten carbide delicate 230mm long
SC-GI/037BM	Tungsten carbide delicate 250mm long
SC-GI/038BM	Tungsten carbide delicate 305mm long

## Castroviejo Needle Holder

Code	Description
SC-OP/021	140mm long, with catch
SC-OP/020	140mm long, without catch

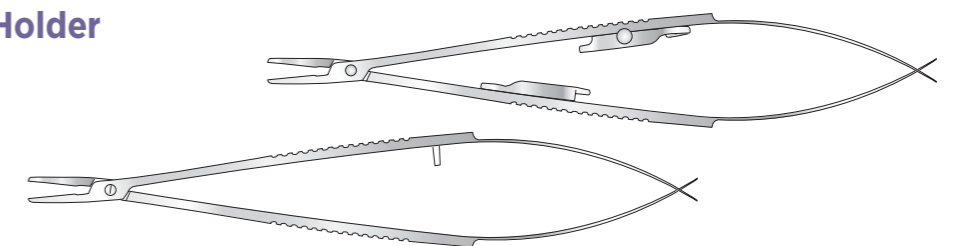

### Diamond dust jaws

Code	Description
SC-THO/060	180mm long, without catch
SC-THO/061	200mm long, without catch
SC-THO/062	215mm long, without catch

ALSO AVAILABLE WITH CATCH - ADD SUFFIX CTH TO CODE

### Tungsten carbide jaws

Code	Description
SC-THO/058a	180mm long
SC-THO/058	200mm long
SC-THO/059	215mm long

ALSO AVAILABLE WITH CATCH - ADD SUFFIX CTH TO CODE

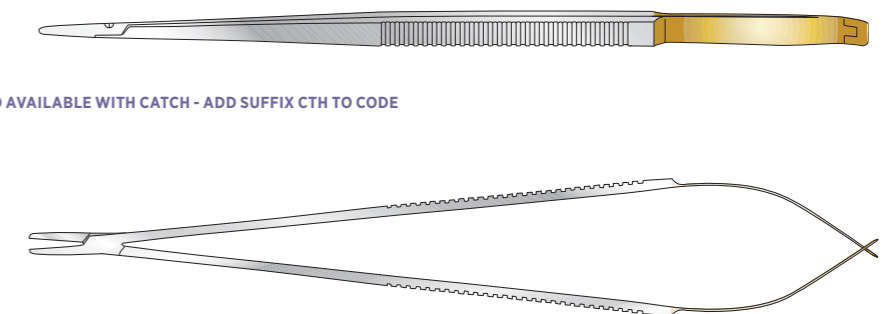

# Retractors

## Blanco Valve Leaflet Retractor

280mm long

Code
SC-THO/041

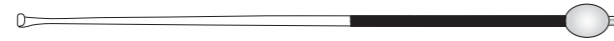

## Harrington Splanchnic Retractor

Small size, end of blade  
38mm wide x 127mm deep  
satin finish handle

Code	Description
SC-THO/011	320mm long

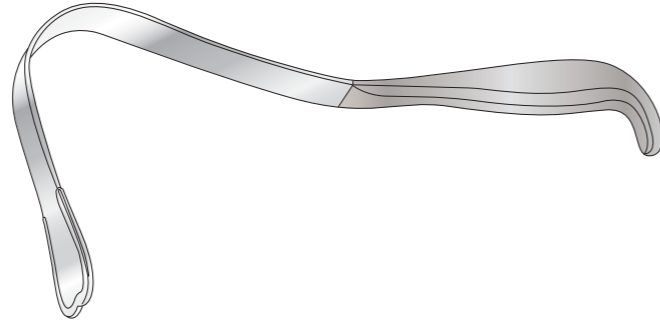

## Brocks Erecton Spinal Back End Retractor

215mm long

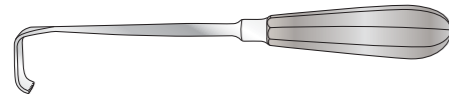

Code	Description
SC-THO/054	13 x 28mm

## Cleland Valve Leaflet Retractor

250mm long



Code
SC-THO/097

## Ross Retractor

250mm long

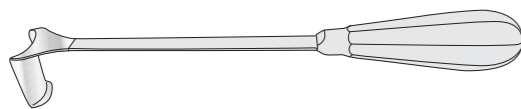

Code	Description	Code	Description
SC-THO/089	16mm x 15mm blade	SC-THO/089c	27mm x 13mm blade
SC-THO/089a	23mm x 13mm blade	SC-THO/089d	27mm x 27mm blade
SC-THO/089b	24mm x 16mm blade	SC-THO/089e	25mm x 38mm blade

## Tudor Edwards Retractor

25mm Wide

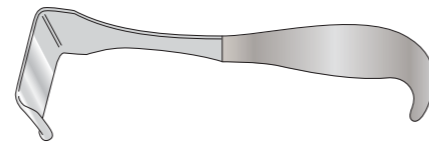

Code	Description
SC-THO/013	205mm long

## Allison Lung Retractor

Satin finish handle

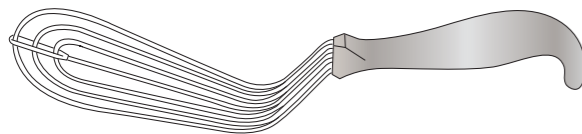

Code	Description
SC-THO/012a	Infant
SC-THO/012b	Child, 280mm blade
SC-THO/012c	Adult, 300mm blade

## Cooley Atrial Retractor

260mm overall length

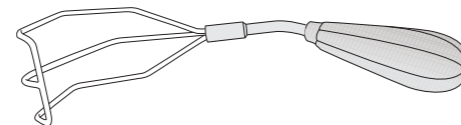

Code	Description
SC-THO/046	Right
SC-THO/046a	Left

# Rib Spreaders

## Finochietto Rib Spreader

Straight arms, 20mm square blades

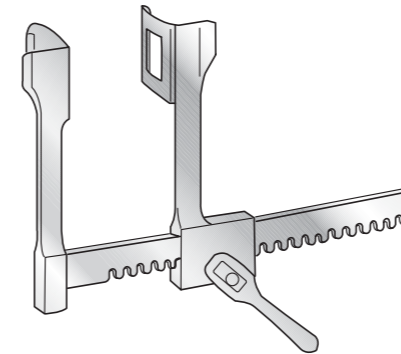

Code	Description
SC-THO/006	Infant, maximum opening 80mm x 60mm long
SC-THO/037	Adult, maximum opening 200mm, blades 44 x 65mm

## Morse-Favaloro Rib Spreader

Curved arms, 275mm long

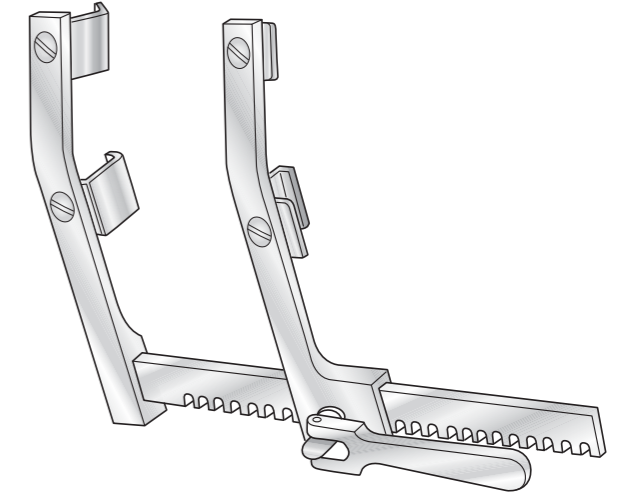

Code	Description
SC-THO/103	Swivel blades 215mm long
SC-THO/103a	Swivel blades 185mm long

## IMA Rib Spreader

Converts left or right

Code	Description
SC-THO/102	Standard frame only
SC-THO/102a	Ministernotomy frame only
SC-THO/102b	Complete, standard, 1 x frame, 1 x 100mm long x 20mm wide U shaped blade, 1 x claw blades 28mm and 32mm deep
SC-THO/102c	Complete, ministernotomy, 1 x frame, 1 x 30mm long x 20mm wide U shaped blade, 1 x claw blades 43mm and 50mm deep

### Claw blade only

Code	Description
SC-THO/102d	28mm deep
SC-THO/102e	32mm deep
SC-THO/102f	38mm deep
SC-THO/102g	43mm deep
SC-THO/102h	50mm deep

### U shaped blade only

Code	Description
SC-THO/102i	100mm long x 20mm wide
SC-THO/102j	100mm long x 25mm wide
SC-THO/102k	30mm long x 20mm wide

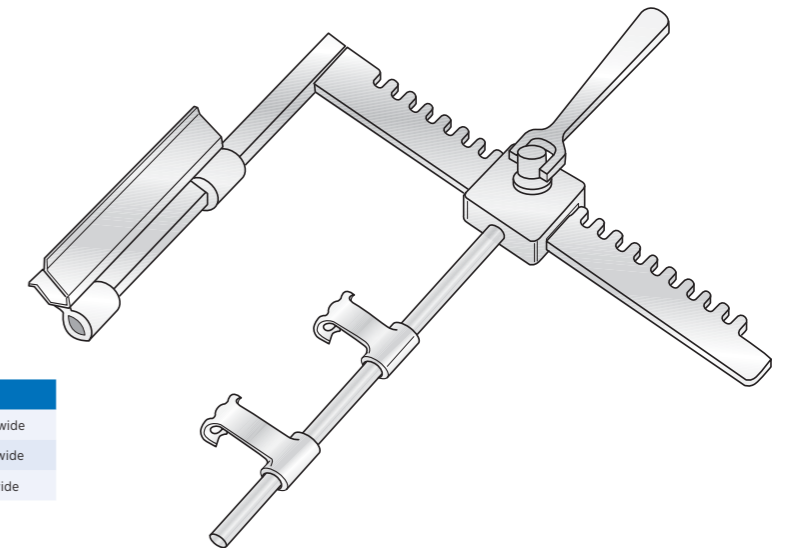

## Price Thomas Rib Spreader

Code	Description
SC-THO/99	Complete with 3 pairs of blades, key, 250, 215, 68mm
SC-THO/99a	Blade only, 50mm x 38mm, pair
SC-THO/99b	Blade only, 50mm x 45mm, pair
SC-THO/99c	Blade only, 50mm x 65mm, pair
SC-THO/99d	Nut and bolt for blade only
SC-THO/99e	Frame only
SC-THO/99f	Key only

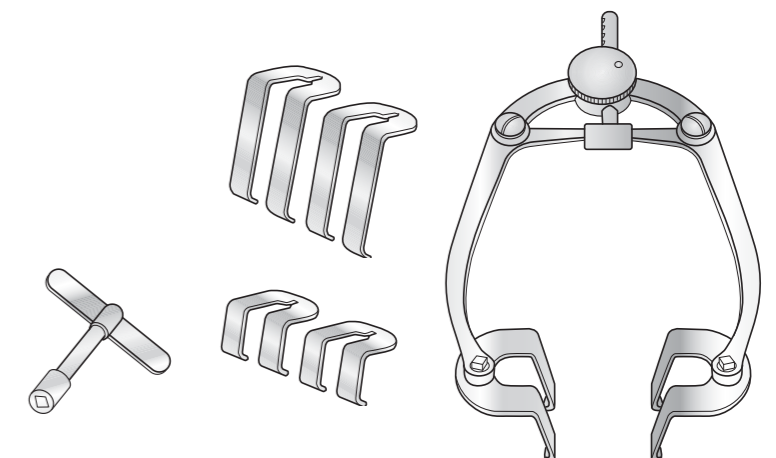



# Rib Spreaders

## Sellors Rib Spreader

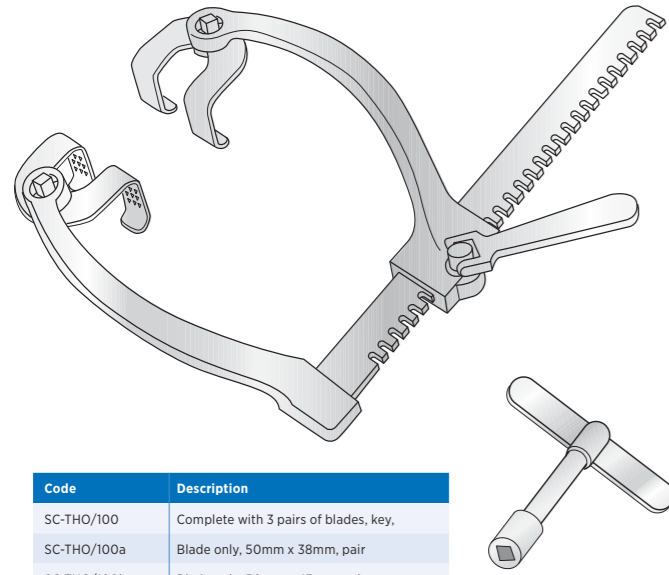

Code	Description
SC-THO/100	Complete with 3 pairs of blades, key,
SC-THO/100a	Blade only, 50mm x 38mm, pair
SC-THO/100b	Blade only, 50mm x 45mm, pair
SC-THO/100c	Blade only, 50mm x 65mm, pair
SC-THO/100d	Frame only
SC-THO/100e	Nut and bolt for blade only
SC-THO/100f	Key only

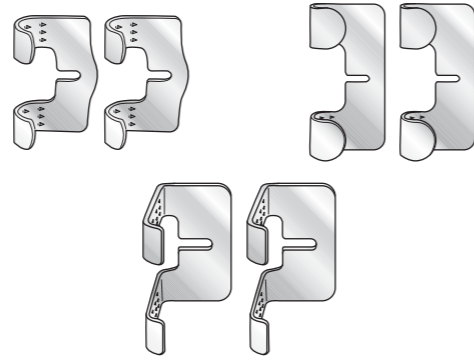

### Harefield sternal blade only, pair

Code	Description
SC-THO/100g	70 x 30mm
SC-THO/100h	120 x 30mm

### Harefield scapula blade only, pair

Code	Description
SC-THO/100i	75 x 70mm

## Ronald Edwards Rib Spreader

Curved arms, fenestrated

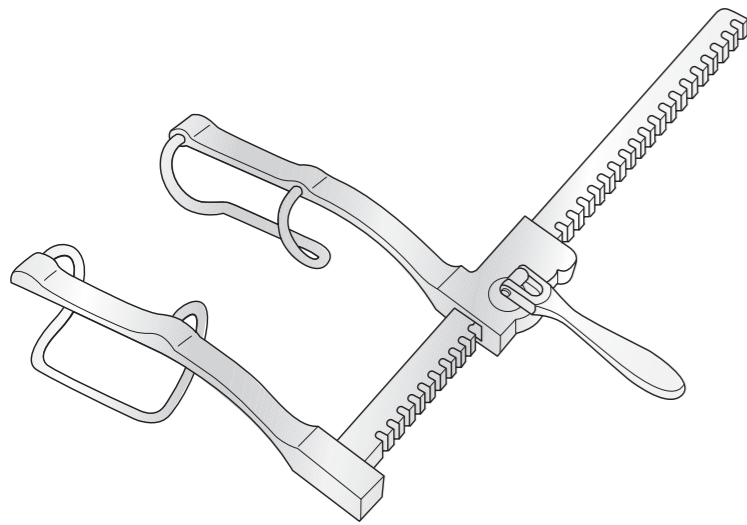

Code	Description
SC-THO/104	Infant, 100mm, 25mm x 30mm blades
SC-SH-5158	Child, 150mm, 30mm x 50mm blades
SC-SH-5720	Adult, 245mm, 65mm x 75mm blades

## Bailey Rib Approximator and Spreader

Combined, satin finish

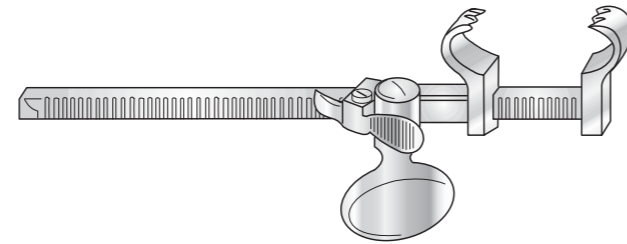

Code	Description
SC-THO/003	160mm long

## Sellors Rib Approximator and Spreader

Combined action, satin finish

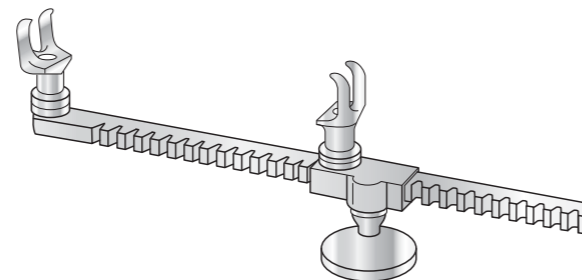

Code	Description
SC-THO/002	195mm long

## Cooley Rib Spreader

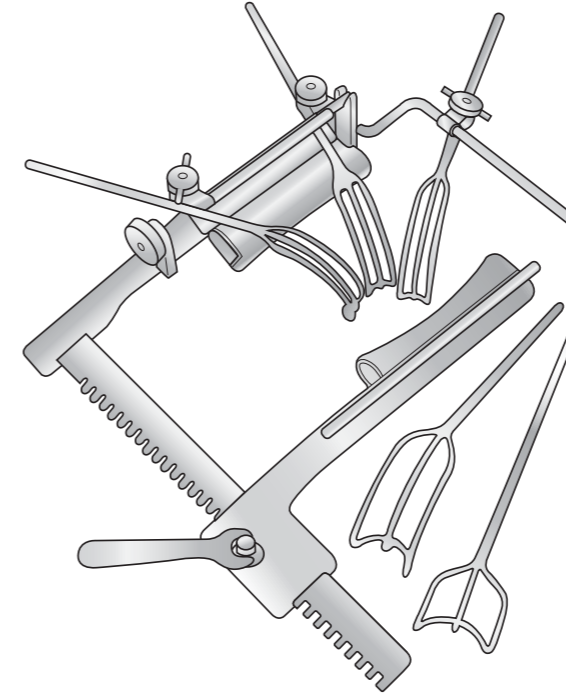

Code	Description
SC-43950-50	Adult, 40mm x 110mm blades, complete with cosgrove mounting bars
SC-43950-90	Adult, 40mm x 110mm blades, complete with cosgrove mitral valve retractor attachment, 5 x blades, 3 x clamp, 1 x side arm

## Wells Rib Spreader

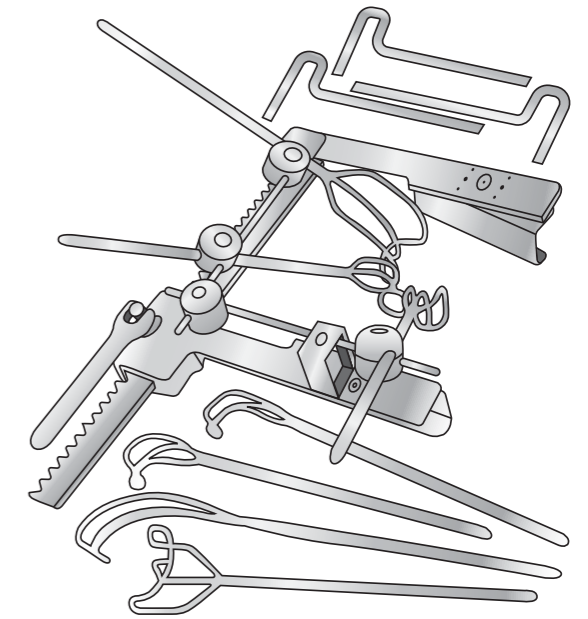

Code	Description
SC-44080-65	Small rake retractor on shaft
SC-44080-80	Frame only, 90mm wide x 25mm deep blades
SC-44080-90	Complete, frame, pillar clamp, 4 x ball clamps, 2 x mounting bars, hex keys, 1 x tricuspid rake ret, 2 x small, medium and large rake ret

## Tudor Edwards Rib Spreader

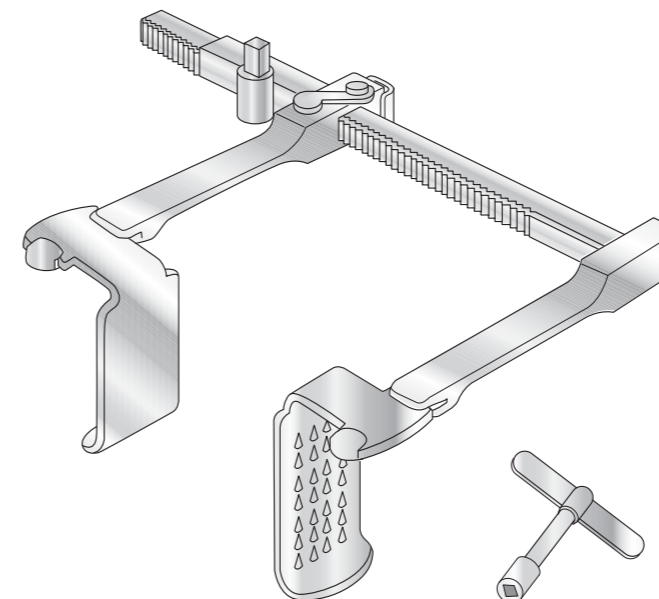

Code	Description
SC-THO/101	Complete, 2 of each blade, plus key
SC-THO/101a	25mm blade only, pair
SC-THO/101b	50mm blade only, pair
SC-THO/101c	75mm blade only, pair

## Tuffier Rib Spreader

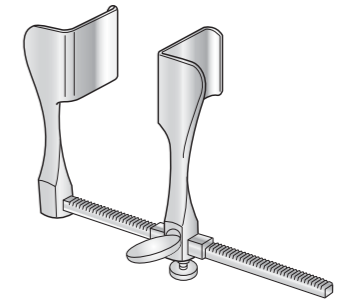

Code	Description
SC-THO/005	Blades 25mm deep x 19mm wide

## Vehmehren Rib Holder and Costotome

Satin finish handles

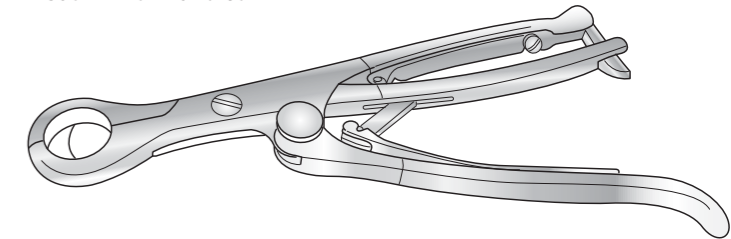

Code	Description
SC-THO/010	240mm long

# Rib Shears and Lung Forceps

## Giertz Rib Shears

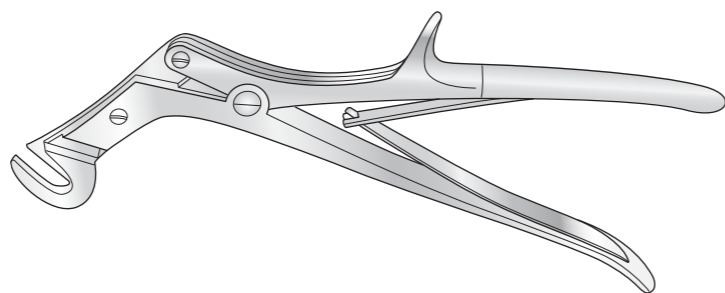

Code	Description
SC-THO/041	270mm long

## Tudor Edwards Rib Shears

Compound action, anterior

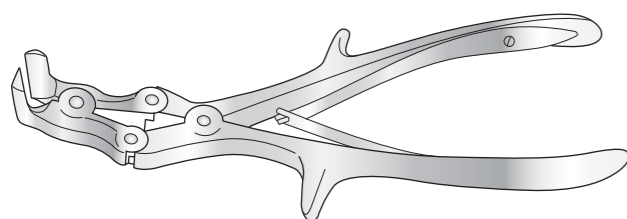

Code	Description
SC-THO/042	235mm long

## Mayo Lung Forceps

Fenestrated, semi-circular jaw, satin finish



Code	Description
SC-THO/014	230mm long

# Elevators and Miscellaneous

## Tudor Edwards Periosteal Elevator

First rib, 175mm long

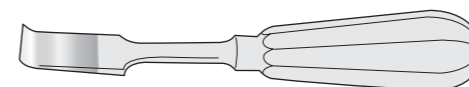

Code	Description
SC-THO/009b	18mm wide

## Doyen Periosteal Elevator

Satin finish handle

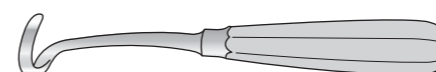

165mm long

Code	Description
SC-OR/N031	Right
SC-OR/N032	Left

180mm long

Code	Description
SC-OR/256	Right
SC-OR/255	Left

## Blalock Hook

249mm long



Code	Description
SC-THO/042	45° angle, 5mm tip
SC-THO/043b	90° angle, 5mm tip

## Ross (Papworth) Ventricular Sucker

33mm long



Code	Description
SC-THO/PAP001	Bullet

## Ross (Papworth) Sump Sucker

42mm long

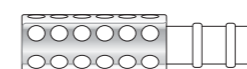

Code	Description
SC-THO/PAP002	Round end

## Ross (Papworth) Flat Sucker

42mm long

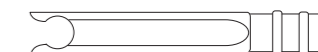

Code
SC-THO/PAP003

## Ross Probe

200mm long

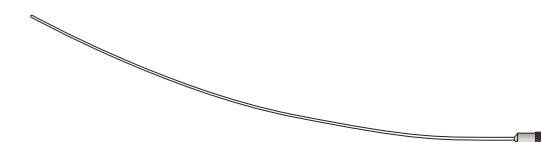

Code	Description
SC-THO/055	1mm
SC-THO/055a	1.5mm

## Tibbs Arterial Cannula

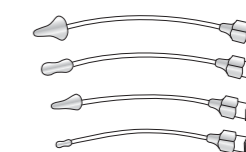

GU pattern

Code	Description	Code	Description
SC-TIB/001	Set of four	SC-TIB/006	Large cone
SC-TIB/002	Large cone	SC-TIB/007	Large olive
SC-TIB/003	Large olive	SC-TIB/008	Small cone
SC-TIB/004	Small cone	SC-TIB/009	Small olive
SC-TIB/005	Small olive	SC-TIB/010	Set of four

## Special Care Needed For Your Thoracic Instruments

### Staining



Beware of the use of Saline during surgery. This can be very damaging to any instrument if not immediately rinsed after surgery. Saline is highly corrosive. The image shows damage to the passive surface of an instrument.

### Rusting



Due to the nature of their use, Thoracic Retractors can tarnish or present rust easily. These retractors can be fully refurbished and passivated by Surgical Holdings.

# Urology

Retractors	229
Forceps	229
Urethral Sounds	230
Urethral Bougies	230
Miscellaneous	232



## Retractors and Forceps

### Walton Bladder Retractor

Code	Description
SC-UR/001	Parallel action, with convex lateral blades - 25mm x 70mm and curved central blade - 70mm x 215mm

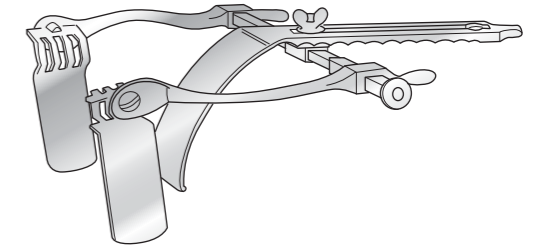

### Thompson Walker Bladder Retractor

Code	Description
SC-UR/002	One posterior blade 95mm x 30mm, one anterior wall blade 175mm x 25mm tapering to 20mm, two pairs of lateral swivel blades, shallow: 55mm x 22mm, deep: 75mm x 25mm

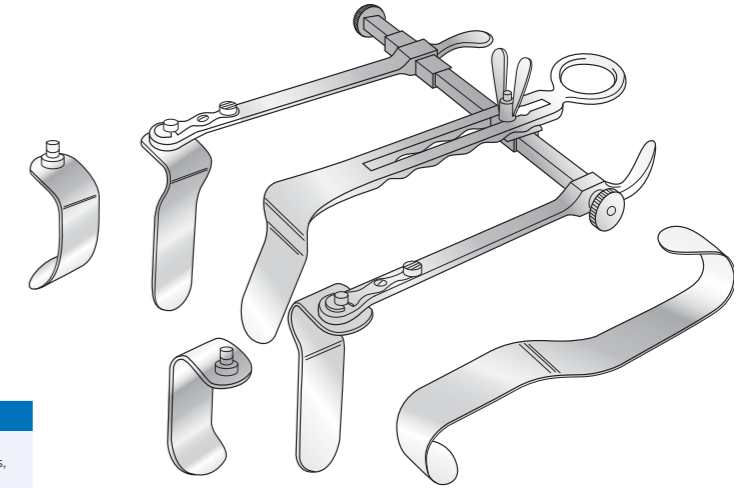

### Millin Retropubic Retractor

Self retaining

Code
SC-UR/003

#### Millin retractor blades

Code	Description
SC-UR/004a	Short 25 x 55mm
SC-UR/004b	Long 25 x 80mm
SC-UR/004c	Centre 115 x 445mm

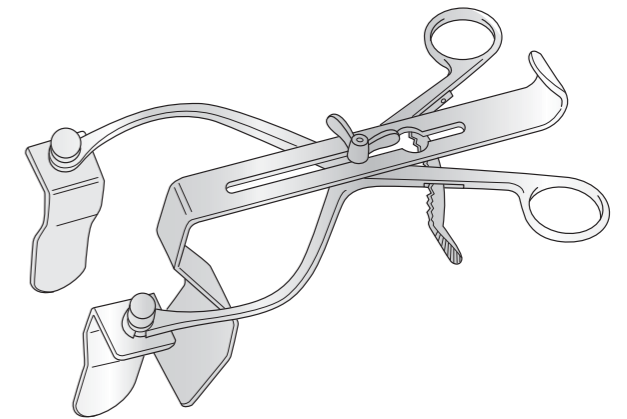

### Millin Vulsellum Forceps

Screw joint for capsule, 225mm long

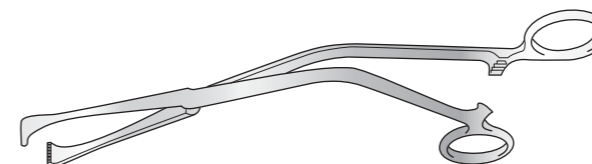

Code	Description
SC-UR/018	8-9 teeth, jaws 10mm wide

### Millin Dissecting Spring Forceps

230mm long



Code	Description
SC-UR/014	3-4 teeth

# Urethral Sounds and Bougies

## Clutton Urethral Sounds

French gauge tapering, 265mm long



Code	Description
SC-UR/007	Set of 12 contains SC-UR/008 to SC-UR/008k

Code	Description	Code	Description
SC-UR/008	6 - 10	SC-UR/008f	18 - 22
SC-UR/008a	8 - 12	SC-UR/008g	20 - 24
SC-UR/008b	10 - 14	SC-UR/008h	22 - 26
SC-UR/008c	12 - 16	SC-UR/008i	24 - 28
SC-UR/008d	14 - 18	SC-UR/008j	26 - 30
SC-UR/008e	16 - 20	SC-UR/008k	28 - 32

## Lister Urethral Sounds

English gauge with olive ends, straight, 280mm long



Code	Description	Code	Description
SC-UR/010	0 - 1	SC-UR/010f	4 - 7
SC-UR/010a	0 - 2	SC-UR/010g	5 - 8
SC-UR/010b	0.5 - 3	SC-UR/010h	6 - 9
SC-UR/010c	1 - 4	SC-UR/010i	7 - 10
SC-UR/010d	2 - 5	SC-UR/010j	8 - 11
SC-UR/010e	3 - 6	SC-UR/010k	9 - 12

## Winsbury White Urethral Bougie

French gauge, child size, 175mm long

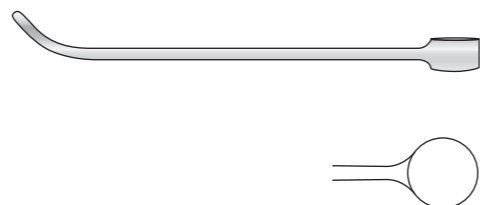

Code	Description
SC-UR/063	1-4 to 3-6
SC-UR/064	5-8 to 7-10
SC-UR/065	9-12 to 11-14

## Canny Ryall Meatal Urethral Bougie

English gauge, double-ended, tapering 160mm long

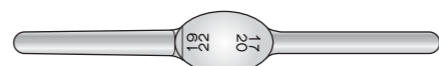

Code	Description
SC-UR/075	1-4 and 3-6
SC-UR/076	5-8 and 7-10
SC-UR/077	9-12 and 11-14
SC-UR/078	13-16 and 15-18
SC-UR/079	17-20 and 19-22
SC-UR/080	21-23 and 22-24
SC-UR/081	26-28 and 29-31

# Urethral Bougies

## Buckston Browne Urethral Bougie

English gauge, 295mm long

Code	Description	Code	Description
SC-UR/020	4-6	SC-UR/027	11-13
SC-UR/021	5-7	SC-UR/028	12-14
SC-UR/022	6-8	SC-UR/029	13-15
SC-UR/023	7-9	SC-UR/030	14-16
SC-UR/024	8-10	SC-UR/031	15-17
SC-UR/025	9-11	SC-UR/032	16-18
SC-UR/026	10-12		



## Clutton Urethral Bougie

French gauge, 260mm long

Code	Description	Code	Description
SC-UR/033	6 - 10	SC-UR/039	18 - 22
SC-UR/034	8 - 12	SC-UR/040	20 - 24
SC-UR/035	10 - 14	SC-UR/041	22 - 26
SC-UR/036	12 - 16	SC-UR/042	24 - 28
SC-UR/037	14 - 18	SC-UR/043	26 - 30
SC-UR/038	16 - 20	SC-UR/044	28 - 32

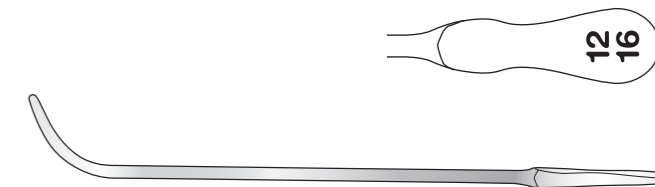

## Guyon Urethral Bougie

French gauge, 275mm long

Code	Description
SC-UR/046	6-24

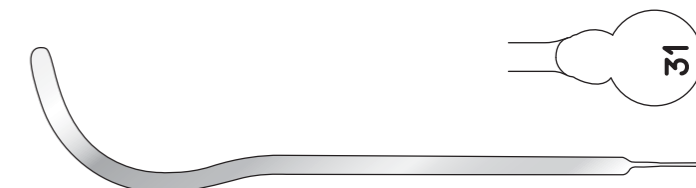

## Lister Urethral Bougie

English gauge, 270mm long

Code	Description	Code	Description
SC-UR/047	4-7	SC-UR/053	10-13
SC-UR/048	5-8	SC-UR/054	11-14
SC-UR/049	6-9	SC-UR/055	12-15
SC-UR/050	7-10	SC-UR/056	13-16
SC-UR/051	8-11	SC-UR/057	14-17
SC-UR/052	9-12	SC-UR/058	15-18



## Wyndham Powell Urethral Bougie

French gauge, 170mm long

Code	Description	Code	Description	Code	Description
SC-UR/059	12	SC-UR/062a	19	SC-UR/065	26
SC-UR/060	13	SC-UR/059b	20	SC-UR/066a	27
SC-UR/061	14	SC-UR/060b	21	SC-UR/067a	28
SC-UR/062	15	SC-UR/061b	22	SC-UR/068a	29
SC-UR/059a	16	SC-UR/062b	23	SC-UR/069a	30
SC-UR/060a	17	SC-UR/063	24	SC-UR/070a	31
SC-UR/061a	18	SC-UR/064	25	SC-UR/071a	32



## Reliable Repair for your Urology Scopes

We repair all major brands of rigid endoscopes at our ISO 13485 accredited workshop in Southend-on-Sea.

Using the latest optical technology, our highly skilled and experienced technicians will return scopes to the manufacturer's original specification.

Contact us to arrange your endoscope repair at [info@surgicalholdings.co.uk](mailto:info@surgicalholdings.co.uk)

+  
All parts  
are **brand new**  
and have **full**  
**traceability**



**Millin Bladder Neck Spreader**

Self retaining, angled jaw

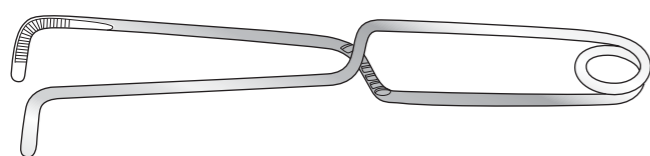

Code	Description
SC-UR/015	240mm long

**Sieve**

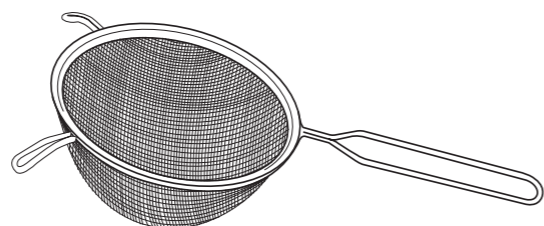

Code	Description
SC-GI/5071	203mm x 50mm

**Introducing the Bookwalter® Retractor System**

symmetry surgical  
authorised distributor

The Bookwalter is widely used in Urology and General Surgery. The retractor is popular for Renal Transplant use and Radical Cystectomy (Bladder Removal).

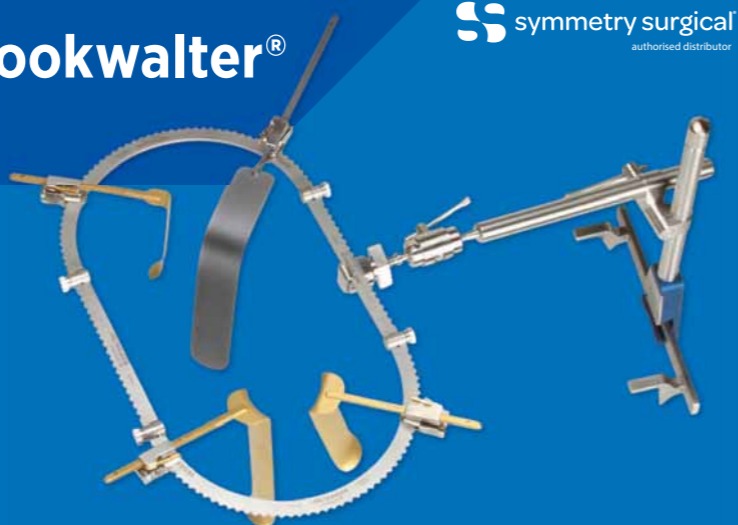

**Radical Cystectomy**

Surgery to remove the urinary bladder. In men, removing the entire bladder (radical cystectomy) typically includes removal of the prostate and seminal vesicles. In women, radical cystectomy also involves removal of the uterus, ovaries and part of the vagina.

(Source: Mayo Clinic)

**Prostate Removal**

Radical prostatectomy is surgery to remove the entire prostate gland and surrounding lymph nodes as treatment for men with localized prostate cancer.

**Renal Transplantation**

The organ transplant of a kidney into a patient with end-stage kidney disease.

**Own a Bookwalter® already?**

Surgical Holdings can Repair & Refurbish your current retractor to make it look as good as new. We will also perform tests to ensure the retractor is functioning correctly and provide a report.

To order email [info@surgicalholdings.co.uk](mailto:info@surgicalholdings.co.uk)

**A**

Abbey Diathermy Needle	57
Abel Abdominal-Perineal Scissors	208
Adson Artery Forceps	10
Adson Bipolar Forceps	56
Adson Dissecting Forceps	14, 115
Adson Forceps	55
Adson Frazier Suction Tube	124
Adson Hook	119
Adson Oliver Neuro Hook	119
Adson Periosteal Elevator	123, 169
Agnew (Politzer) Myringotome	85
Albee Osteotome	160
Alexander Gouge	160
Allen Key Sets	173
Allison Lung Retractor	222
Allis Tissue Forceps	16
Alms Skin Retractor	188
American Spinal Fusion Curettes	119
Amputation Saw	202
Aneurysm Needle	40
Arruga Intra Capsule Forceps	133
Artery Scissors	196
Arthrodesis Wires (Sterile)	175
Arthroscope Basket	43
Asch Septum Forceps	183
Aufricht Dissecting Scissors	181
Aufricht Raspatory	185
Austin Kay Retractor	188
Austin Moore Type Raspatory	167
Auvard Vaginal Speculum	99

**B**

Babcock Intestinal Forceps	110
Babcock Lung Grasping Clamps	214
Babcock Tissue Forceps	16
Baby Metzenbaum Scissors	22
Baby Tischler Biopsy Forcep	96

Baby Tischler Biopsy Punch Forcep	96
Backbiters	76
Backhaus Towel Clip	30
Bailey Rib Approximator and Spreader	224
Bakes Bile Duct Dilators	113
Balance Scoop and Curette	62
Balfour Abdominal Retractor	31
Ballance (Volkman) Retractor	38, 156
Ball and Socket Towel Forceps	30
Ballenger Nasal Cartilage Knife	84
Bankhart Bone Lever	153
Barnard's Bowel Scissors	197
Barnard's Saw	202
Barnes Episiotomy Scissors	106
Barnes Obstetric Forcep	98
Baron Scalpel Handle	40, 194
Barraquer Corneal Forceps	132
Barraquer Eye Speculum	137
Barraquer Fixation Forceps	132
Barraquer Iris Scissors	134
Barron Suction Tube	65
Baskets	
Beale Aural Forceps	68
Beale Instruments	60, 61
Beckmann Adenoid Curette	85
Beckmann Turbinectomy Scissors	82
Beck Rongeur	80, 125
Bein Elevator	47
Berkeley-Bonney Hysterectomy Forceps	91
Berkeley Abdominal Retractor	31
Berry Needle Holder/Wire Twister	27
Bipolar Forceps	56
Bipolar Leads	58
Birkett Tonsil Artery Forceps	70
Bistoury Knife	195
Blalock Bulldog Clamp	13, 219
Blalock Hook	227
Blanco Valve Leaflet Retractor	222
Block End Dissecting Forceps	14, 200

Bohler Plaster Shears	147
Bohler Stirrup	174
Bone Curette	148, 151
Bone Cutting Forceps	183
Bone File and Raspatory	167
Bone Holding Forceps	144
Bone Plate Bender/Wire Cutter Pliers	162
Bonney Dissecting Forceps	14
Bonney Hysterectomy Forceps	91
Bonney Myomectomy Clamp	107
Bonney Uterine Polypus Forcep	92
Bowdler Henry Retractor	188
Bowel Scissors	197
Bowlby Dilator	35
Box Chisel	160
Boyd Scissors	24, 220
Boyle-Davis Mouth Gag	74
Brain Knife	195
Braun Stadler Episiotomy Scissors	106
Breisky Vaginal Retractor	101
Bristow Periosteal Elevator	169
Brocks Erecton Spinal Back End Retractor	222
Brodie Director Probe Ended, Silver Plated	39
Bruce-Clarke Needle Holder	25
Bruns Bone Curette	148
Buck Ear Curette	85
Buckston Browne Urethral Bougie	231
Burns Bone Holding Forceps	146
Busche Bone Curette	148
Busch Umbilical Scissors	106

C

Cairns (Dott) Dressing Forceps	116
Cairns-Northfield Laminectomy Retractor	122
Cairns Artery Forceps	10
Cairns Cushing Scalp Retractor	122
Cairns Dissecting Forceps	116
Cairns Guide and Director	118
Cairns Rongeur	126

Cairns Scalp Retractor	120
Cairns Scissors	117
Cairns Strip Retractor	122
Cairns Tissue Hook	119
Cairns 'Rake' Scalp Retractor	122
Calcaneal Spreader	145
Cannula	137
Canny Ryall Army Retractor	36
Canny Ryall Meatal Urethral Bougie	230
Canny Ryall Navy Retractor	36
Capener Chisel	158
Capener Lamina Curette	152
Capener Lamina Gouge	158
Capener Osteotome	158
Capener Spoon	152
Capsule Spreader	178
Careless Scissors	21
Carmalt Angiotribe Forceps	12
Cartilage Cutting Scissors	181
Cartilage Knife	194
Caspar Bone Curette	151
Castroviejo Calliper	138
Castroviejo Corneal Suture Forceps	133
Castroviejo Needle Holder	136, 182, 221
Castroviejo Scissors	134
Catheter	104
Catheter Introducer	104, 105
Catlin Knife	194
Cawthorne Aural Forceps	68
Cawthorne Cerumen Hook	63
Cawthorne Hooks	61
Cawthorne Nibbling Forceps	73
Cawthorne Probe	63
Cawthorne Scissors	83
Chalazian Sharp Spoons	138
Charnley-McIndoe Dissecting Forceps	14, 156
Charnley Bone Curette	150
Charnley Cup Pusher	168
Charnley Initial Incision Retractor	154
Charnley Prosthesis Pusher	168

Charnley Saws	173
Charnley Suture Forcep	164
Cheatle Jar	41
Cheatle Sterilizer Forceps	18
Cheek Retractor	188
Chevalier Jackson Endoscope Forcep	78
Chevalier Jackson Vocal Nodule Endoscope Forcep	78
Childe Approximating Forceps	19, 187
Chirobloc Hand Immobiliser	177
Chisel	203
Citelli Antrum Punch	79
Clark Speculum	137
Cleft Palette Raspatory	184
Cleland Valve Leaflet Retractor	222
Clutton Urethral Bougie	231
Clutton Urethral Sounds	230
Cobb Spinal Elevator	123
Coil Removing Forcep	93
Coleman Elevator	47
College Pattern Stopping and Dressing Forceps	187
Collin Mallet	166
Collin Retractor	34
Collin Rib Shears	173
Collin Vaginal Speculum	99
Compound Action Bone Rongeur	143
Cone Laminectomy Retractor	120, 121
Cone Retractor	120
Cooley Artery Clamps	212
Cooley Atrial Retractor	222
Cooley Rib Spreader	225
Cottle Bulldog Scissors	82
Cottle Elevator	84
Cottle Nasal Speculum	67
Cottle Scissors	82
Coupland Elevator	47, 184
Crile-Wood Needle Holder	25, 27
Crile Artery Forceps	10
Cryer-White Elevator	47
Cryer Elevator	47, 184

Cryer Tooth Forceps	51
Cryer Tooth Forceps for Children	52
Cusco Vaginal Speculum	99
Cushing Artery Forceps	10
Cushing Periosteal Elevator	123
Cushing Rongeur	80, 125
Cushing Screw Joint Bone Rongeur	143
Czerny Retractor	36

D

Dandy Artery Forceps	12
Dandy Rongeur	124
Daniel Rongeur	126
Danish Pattern Rongeur	126
Dartigues Uterine Forceps	92
Deaver Abdominal Retractors	37
DeBakey 45° Paediatric Clamp	218
DeBakey 90° Paediatric Clamp	218
DeBakey Atraumatic Clamp	216, 217
DeBakey Atraumatic Dissecting Clamps	215
DeBakey Atraumatic Dissecting Forceps	14
DeBakey Bainbridge Clamps	212
DeBakey Clamp	216
DeBakey Clamps	212, 213
DeBakey Coarctation Clamp	218
DeBakey Multipurpose Clamp	218
DeBakey Needle Holder	28, 221
DeBakey "S" Shaped Clamp	216
Denham Pin	174
Denis Browne Collar Crushing Forceps	73
Denis Browne Intestinal Forceps	110
Denis Browne Tonsil Artery Forceps	70
Denis Browne Tonsil Holding Forceps	71
Dental Cartridge Syringe	191
Dental Pick	187
Derf Needle Holder	27, 182
Desjardin Gall Stone Forceps	110
Desmarre Entropian Forceps	133
Desmarre Eyelid Retractor	137

de Wecker Iris Scissors	134
Diathermy Arm	57
Dieffenbach Bulldog Clamp	13, 219
Diethrich Bulldog Clamp	219
Diethrich Circumflex Artery Scissors	220
DIN Basket	42
DIN Basket Lids	42
Dislocation Hip Hook	156
Dislocation Hook	156
Dissecting Forceps	14, 55, 200
Dissecting Scissors	196, 197
Dissector	118
Dott Dissecting Forceps	116
Dott Dressing Forceps	116
Doughty Tongue Plate	75
Doyen Intestinal Clamp	113
Doyen Mouth Gag	74, 191
Doyen Myoma Screws	107
Doyen Ovarian Forceps	93
Doyen Periosteal Elevator	169, 227
Doyen Rectangular Retractor	101
Doyen Retractor	101
Draffin Bipod	74
Dressing Scissors, Left-Handed	20
Dressing Scissors	20, 22, 23, 24, 196
Dubois Uterine Scissors	106
Dunhill Artery Forceps	10
Dunhill Dissecting Forceps	14
Dura Mater Stripping Forceps	201
Durham Retractor	38, 204
Durogrip Raspatory	185
Duval Lung Grasping Clamps	214
Duval Tissue Forceps	16
Dyball and Lock Retractor	37
<b>E</b>	
Eccentric Plaster Shears	147
Echlin Compound Action Bone Rongeur	142
Eckhoff Mapping Pen	191

Eisenhammer Speculum	209
Elliot (Modified Deaver) Retractor	37
Endoscope Basket	43
Engel Plaster Saw	147
ENT Basket	43
Epilation Forceps	132
Eppendorf Biopsy Punch Forcep	94
Eslander Rib Shears	199
Extracting Forceps	48, 49, 50
<b>F</b>	
Fakuda Type Retractor	172
Falconer Rongeur	124, 126
Falconer Scoop Curette	119
Farabeuf-Lambotte Bone Holding Forceps	144
Farabeuf Bone Holding Forceps	144
Farabeuf Elevator	184
Farabeuf Rugine	157
Faures Peritoneum Forceps	91
Femoral Pusher	168
Fergusson Ackland Mouth Gag	74, 191
Fergusson Bone Holding Forceps	144
Fergusson Scissors	20
Fergusson "Lion" Bone Holding Forceps	198
Ferris Smith Kerrison Punch	79
Fickling (Cathcart) Scissors	181
Fickling Artery Forceps	70, 183
Fickling Dental Mallet	190
Finch Excision Clamp	207
Fine Hand Set	176
Fine Mesh Basket	43
Finger Switch Pencil	57
Finochietto Needle Holder	27
Finochietto Rib Spreader	223
Fixed Back Saw	202
Flap Retractor	189
Flexible Chisels and Blades	176
Foerster Sponge Holding Forceps	18
Fomon Raspatory	185

Fomon Scissors	82
Formby Cerumen Scoop and Hook	62
Formby Suction Tube	65
Foster Gillies Scissor/Needle Holder	29
Foster Scissor/Needle Holder	182
Fraser Kelly Artery Forceps Curved	11
Frazier Suction Tubes	124
Fredrick Coole Dissecting Forceps	14
Freece Oral Retractor	189
Freeman Areola Nipple Sizer	192
Freer Instruments	86
Freer Separator and Elevator	86
Frosch Bone Holding Forceps	145
Fukuda-Kujat Humeral Head Retractor	178
<b>G</b>	
Galabin Uterine Sound	108
Gallagher Raspatory	185
Gallipot	41
Gardiner Brown Hook and Imray Loop	63
Gelpi Retractor	34
Giertz Rib Shears	226
Gigli Saw Handles	173
Gigli Saws	173
Gillies (French Pattern) Osteotome	190
Gillies Dissecting Forceps	15, 187
Gillies Scissor/Needle Holder	29
Gillies Skin Hook	38, 187
Gillies Suction Tube	191
Glasgow Pattern Rongeur	127
Goligher Retractor	31
Goligher Scissors	208
Gorney Supercut Scissors	181
Gossett Abdominal Retractor	34
Gouge	203
Gourdets Bone Curette	149
Graefe Knife	138
Graves Vaginal Speculum	99
Green-Armytage Haemostasis Forcep	93

Greenhalgh Ovum Forcep	92
Grunwald Nasal Punch Forceps	76
Guard/Shoe	112
Guyon Urethral Bougie	231
Guys Gallabin Suture Holding Forceps	17
Guys Plaster Shears	147
Guys Tenotomy Knife	173
Guy's Hospital Nasal Gouge	84
Gwilliam Hysterectomy Forceps	91
Gwynne-Evans Tonsil Dissector	86
<b>H</b>	
Haglund Plaster Spreader	147
Haig Ferguson Obstetric Forcep	98
Hajek Antrum Punch	79
Hajek Retractor	189
Hajek Sphenoidal Punch	79
Halsey Needle Holder	27
Halstead Mosquito Forceps	11
Hammer	204
Hardinge Cement Restrictor	168
Harrington Splanchnic Retractor	222
Harrison Bone Holding Forceps	145
Harrison Bowl Sterilizer Forceps	18
Harrison Butler Lachrymal Cannula	137
Hartman Intestinal Clamp	112
Hartmann Aural Forceps	68, 69
Hartmann Conchotomes	71
Hartmann Dressing Forceps	72
Hartmann Hook	63
Harvey-Jackson Laminectomy Retractor	121
Hawkin Ambler Cervix Dilators	108
Hays Colon Resection Clamp	207
Heaney Hysterectomy Forceps	91
Heanley Rongeur	127
Heath Aural Forceps	69
Heath Mallet	165
Heath Speculum	66
Heath Stitch Scissors	21

Hegar Cervix Dilator	108	Irwin Moore Nasal Turbinate Forceps	71	Kevorkian Biopsy Curette	103	Lambert-Kay Clamps	215
Heiss Artery Forceps	11	Irwin Moore Thyroid Clamp	72	Kevorkian Biopsy Punch Forcep	95	Lambotte Bone Holding Forceps	144
Henckel Aural Forceps	69	Irwin Retractor	35	Key Periosteal Elevator	169	Lambotte Osteotome	159
Henderson Retractor	120			Key Raspatories	157	Lambotte Raspatory	157
Henning Plaster Spreader	147	<b>J</b>		Kidney Dish	41	Landon Retractor	36
Hey Groves Bone Holding Forceps	144	Jackson Burrows Dissecting Forceps	15, 156	Kieland Obstetric Forcep	98	Landon Vaginal Retractor	102
Heymann Turbinectomy Scissors	82	Jackson Burrows Hand Retractor	156	Killian Nasal Gouge	84	Lane Bone Lever	153
Hibbs Retractor	122	Jackson Burrows Retractor	155	Killian Nasal Speculum	67	Lane Bowel Clamp	201
Hill Elevator	84	Jameson Evans Cilia Forceps	133	Kilner Alae Retractor	188	Lane Intestinal Forceps	111
Hinged Back Saw	202	Jansen (Shea) Retractor	120	Kilner Cheek Retractor	189	Lane Retractor	36
Hip Set	154	Jansen-Middleton Nasal Septum Forceps	71	Kilner Dissecting Scissors	20	Lanes Dissecting Forceps	15
Hohmann-Aldinger Bone Elevator	170	Jansen-Middleton Septum Forceps	183	Kilner Dott Mouth Gag	74	Lane Stomach Holding Forceps	110
Hohmann-Muller Spike Elevator	170	Jansen Rongeur	127	Kilner Dott Tongue Plate	75	Lane Tissue Forceps	16
Hohmann Bone Elevator	170	Jean Dissecting Forceps	15, 200	Kilner Nasal Retractor	189	Lane Twin Stomach Clamp	113
Hohmann Bone Lever	171	Jefferson Dressing Forceps	115	Kilner Needle Holder	25, 27	Lange-Hohmann Bone Elevator	171
Hohmann Retractor	172	Jefferson Forceps	115	Kilner Retractor	38, 188	Langenbeck Bone Hook	156
Hohmann Tapered Spike Retractor	172	Jefferson Retractor	120	Kilner Scissors	181	Langenbeck Elevator	169
Horsley Bone Cutter	198	Jenkins Chisel	190	Kirschner Wires (Sterile)	175	Langenbeck Retractor	36
Horsley Compound Action Bone Cutter	141	Jenkins Gouge	84	Kleinert Kutz Bone Rongeur	141	Lang Eyelid Retractor	137
Hough Aural Forceps	68	Jobson Horne Probe	63	Kleinert Kutz Skin Hooks	141, 187	Lang Lachrymal Cannula	137
Hough Instruments	61	Jobson Horne Probe Dressing (Aural)	39	Knapp Scissors	83	Lang Steel Scoop	192
House Curette	62	Joint Calcaneal Spreader	145	Kocher Artery Forceps	11	Lang Stevenson Intestinal Forceps	112
House Suction and Irrigation Tubes	65	Jones Towel Clip	30	Kocher Bone Hook	156	Laster Cheek Retractor	189
Hovell Loop	62	Joseph Double Skin Hook	187	Kocher Intestinal Forceps	111	Lateral Vaginal Retractor	102
Howarth Elevator	184	Joseph Nasal Saw	192	Kocher Langenbeck Retractor	36	Lawrence Needle Holder	25, 182
Hunter Splinter Forceps	19	Joseph Raspatory	185	Kocher Retractor	36, 38	Lawson Tait Artery Forcep	10
Hurd Pillar Retractor and Tonsil Dissector	64	Joseph Scissors	82	Kogan Endocervical Forceps	93	Lawton Plaster Spreader	147
		Judet Impactor	168	Kolbel Glenoid Retractor	179	Leads	58
		Julian Needle Holder	221	Kolbel Self Retaining Glenoid Retractor	179	Leksell Compound Action Bone Rongeur	142
		Joll Thyroid Retractor	34	Kolbel Self Retaining Glenoid Retractor Blades	179	Leksell Rongeur	129
<b>I</b>				Kolbel Soft Tissue Retractor	178	Leksell Stille Compound Action Bone Rongeur	142
IMA Rib Spreader	223	<b>K</b>		Kramer Eustachian Catheters	87	Leland-Jones Clamps	215
Infant Skull Shears	199	Keily Ovum Forceps	92	Krayenbuhl Retractor	122	Lempert Box Joint Bone Rongeur	143
Inge Type Lamina Spreader	145	Kelly Artery Forceps	11			Lempert Endaural Speculum	67
Instrument Tray	41	Kelly Proctoscope	209	<b>L</b>		Lempert Nibbling Forceps	73
Ipswich Pattern Sucker	65	Kelly Retractor Blade	37	Lack Tongue Depressor	75	Lempert Rugine	88
Iris Fixation Forceps	132	Kelsey Fry Bone Awl	192	Lahey Cholecystectomy Forceps	110	Lempert Scoop	62
Iris Forceps	132	Kelsey Fry Mallet	166	Lahey Sweet Forceps	110	Lempert Suction and Irrigation Tubes	65
Iris Scissors	24, 134, 197	Kerrison Rongeurs	130	Lake Seeker	88	Lewis Raspatory	185
Ironside Instruments	60					Lexer Osteotome	158
Irwin-Moore Tonsil Needle	88						



Ligature Scissors	22	Maingot Hysterectomy Forceps	91
Ligature Stitch Scissors	20	Maingot Intestinal Forceps	110
Lister Bandage Scissors	21	Mallet	165, 204
Lister Sinus Forceps	18	Maltz Raspatory	186
Lister Urethral Bougie	231	Martin Cartilage Forceps	164
Lister Urethral Sounds	230	Martini Bone Curette	152
Liston Bone Cutting Forceps	198	Masing Needle Holder	28, 182
Liston Box Joint Bone Cutting Forcep	140	Mason Mouth Gag	74
Liston Compound Action Bone Cutting Forcep	140	Mastoid Retractor	120
Liston Screw Joint Bone Cutting Forcep	140	Mathieu Needle Holder	26
Littler Dissecting Scissors	20	Mayo-Adson (Beckmann) Laminectomy Retractor	121
Littlewood Tissue Forceps	16	Mayo-Harrington Dressing Scissors	22
Littlewood Tissue Forceps	94	Mayo-Hegar Needle Holder	28, 200
Lloyd-Davis Rectal Occlusion Forceps	207	Mayo Dissection Scissors	197
Lloyd-Davis Rectal Scissors	208	Mayo Dressing Scissors	22
Lloyd-Davis Retractor	209	Mayo Harrington Scissors	23
Lloyd-Davis Sigmoidoscope	206	Mayo Instrument Pin	40
Lobectomy Scissors	220	Mayo Lung Forceps	226
Lockhart Mummery Fistula Director	208	Mayo Needle Holder	26
Lotion Bowl	41	Mayo Scissors	20, 23, 24
Love-Grunwald Rongeur	125	McClintock Ovum Forcep	92
Love Retractor	122	McGoey Punch	167
Lowa Tenaculum Forceps	93	McHardy Curette	192
Lowman Bone Holding Clamp	146	McIndoe Bone Cutting Forcep	140
Luc Nasal Turbinate Forceps	71	McIndoe Dissecting Forceps	15, 187, 200
Luer-Jansen Rongeur	128	McIndoe Modified Dissecting Forceps	15
Luer Box Joint Bone Rongeur	143	McIndoe Nasal Chisel	190
Luer Compound Action Bone Rongeur	143	McIndoe Raspatory	184
Luer Stille Bone Rongeur	129	McIndoe Scissors	181
Luer Stille Compound Action Bone Rongeur	142	McIndoe Scissors	21
		McIndoe Skin Hook	63
		McKissock Scissors	117
		McKissock Spade Periosteal Elevator	123
		Measuring Jug	41
		Metzenbaum Dissecting Scissors	23
		Metzenbaum Dissecting Scissors Supercut	24
		Metzenbaum Scissors	20, 22, 197
		Meyerding Hemi-Laminectomy Retractor	121
		Michel Clip Extracting Forceps	19

## M

MacDonald Dissector Double Ended	39, 169
MacEwen Curette	192
Mackay Modified Stammberger Punch	77
Mackay Rongeur	81, 125
MacPhail Needle Holder	25
Magill Intratracheal Catheter Clamps	215
Magill Suction Tubes	65

Michel Forceps	19
Michel Skin Holding Forceps	19
Micro Needle Holder	136
Miles Retractor	31
Miller Bone File	167
Miller Raspatory	186
Millin Bladder Neck Spreader	232
Millin Dissecting Spring Forceps	229
Millin Retropubic Retractor	229
Millin Vulsellum Forceps	229
Mini-Lexer Gouges	176
Mini-Lexer Osteotome and Gouge Set	176
Mini-Lexer Osteotomes	176
Mini Fine Hand Osteotomes	176
Mirror (Laryngeal)	87
Mitchell Rugine	157
Mitchell Trimmer	87, 187
Modified Speculum	100
Mole Grip Type Wrench	163
Mollison Anterior Pillar Retractor and Tonsil Enucleator	64
Mollison Retractor	64
Monel Blade	57
Monel Handle	57
Moore Femoral Head Extractor	168
Moore Hollow Osteotome	160
Morris Retractor	37
Morse-Favaloro Rib Spreader	223
Moynihan Retractor	37
Moynihan Artery Forceps	12
Moynihan Cholecystectomy Forceps	111
Moynihan Towel Clip	30
Muller Soft Tissue Retractor	171
Murphy Skids	168
Museux Vulsellum Forceps	90
Musgrove Cerumen Pick and Wool Carrier	62
Mustarde Dissecting and Suture Holding Forceps	187
Mustarde Suture Holding Forceps	183
Myles Naso-Antral Perforator	87

## N

Nasal Curette	85
Nasal Cutting Forceps	76
Naughton Morgan Needle Holder	26
Needle Handles	57
Needle Holder	25
Needle Holder and Wire Twister	221
Needle Point	57
Needles	57
Negus Aspiring Dissector	86
Negus Pusher	88
Negus Tonsil Artery Forceps	70
Nelson Lobectomy Scissor	220
Nievert Needle Holder	28
Norfolk and Norwich Retractor	35, 155
Northfield (Cairns) Retractor	121
Northfield Dressing Forceps	115
Northfield Rongeur	125, 127
Noto Uterine Polypus Forceps	92
Nott Speculum	99
Novak Curette	103

## O

Officer Biopsy Forceps	206
Officer Dissecting Forceps	206
Olivecrona Rongeur	128
Olivecrona Scissors	117
Oliver Tissue Hook	119
Olsen-Hegar Scissor/Needle Holder	29
Ombredanne Mallet	166
Optical Fibre Cables	44, 45
Organ Knife	195
Organ Knife and Saw	195
Ormerod Aural Forceps	68
Ormerod Aural Scissors	83
Orthopaedic Grasping Forceps	146
Orthopaedic Mallet	166
Orthopaedic Plier/Cutter	162, 163

Orthopaedic Pliers	163	Potts Scissors	220	Rosen Aural Speculum	66	Senn-Miller Retractor	38
Orthopaedic Ruler Stainless Steel	173	Pozzi Abdominal Retractors	34	Rosen Instruments	60	Sequestrum (Necrosis) Forcep	145
Ostrom Antrum Punch	77	Pratt Tenaculum Forceps	93	Rosen Slotted Speculum	66	Seton Pringle Intestinal Forceps	111
O'Connell Retractor	122	Price Thomas Rib Spreader	223	Ross (Papworth) Flat Sucker	227	Seymour Jones Antrum Punch Forceps	76
O'Shaughnessy Artery Clamps	214	Probe, Fish Tail Silver Plated	39	Ross (Papworth) Sump Sucker	227	Shah Intra Aural Retractor	64
		Probe, Malleable Silver Plated	39	Ross (Papworth) Ventricular Sucker	227	Shardles Towel Clip	30
		Probe, Sinus Silver	39	Ross Probe	227	Shaw Tissue Forceps	17
		Pterigoideus (Maxilla) Chisel	190	Ross Retractor	222	Shea Aural Forceps	68
		Putti Raspatory	167	Rotunda Hospital Pattern Catheter	104	Shea Speculum	66
				Rowbotham Suction Tube	65	Shroeder Bone Curette	149
<b>P</b>				Royal Cornwall Mallet	165	Sickle Knife	84
Parametrium Clamp Forceps	90			Rubber Mallet	204	Side Cutter	162
Parametrium Scissors	107			Ruskin-Liston Bone Cutting Forcep	140	Side Cutting Forceps	53
Park Anal Retractor	209			Ruskin Compound Action Bone Rongeur	143	Sieve	43, 232
Park Combined Anal Retractor	209	<b>Q</b>		Ruskin Rongeur	128	Silcock Iris Forceps	116
Parker Kerr Intestinal Forceps/Clamp	112	Quivers	58	Russian Dissecting Forceps	17	Silcock Needle Holder	136
Parker Modified Lowman Bone Holding Clamp, Single	146			Rutherford Morrison Tissue Forceps	16	Silicone Matting	42
Parker Retractor	146			Ryder Needle Holder	28	Silver Nasal Chisel	190
Partsch Gouge	160	<b>R</b>				Silver Plated Probe	204
Paterson Biopsy Forceps	77	Ragnell Davis Retractor	188			Silver Probe	204
Paton Bone Burr	157	Ramplsey Sponge Holding Forceps	18	<b>S</b>		Silver Skin Graft Knife	191
Paynes Suture Scissors	20	Ramsey Dissecting Forceps	200	Sarot Needle Holder	28	Simms Uterine Scissors	106
Payr Intestinal Clamp	112	Raspatory	201	Sawtell Tonsil Artery Forceps	70	Simon Bone Curette	149
Pederson Vaginal Speculum	100	Read Chisel	159	Scalpel Blade Remover	204	Simpson Braun Obstetric Forcep	98
Pelvic Organ Knife	194	Read Gouge	159	Scalpel Handle	40, 194	Sims Duckbill Speculum	100
Penfield Dissector	118	Read Osteotome	159	Scarf Type Clamp	146	Sims Uterine Curette	103
Pennybacker Dissecting Forceps	115	Recamier Uterine Curette	103	Schmieden (Taylor) Scissors	117	Sims Uterine Sound	108
Pennybacker Elevator	123, 169	Reduction Forcep	146	Schnitker Scalp Retractor	120	Sims Vaginal Depressor	107
Pennybacker Probe Dissector	118	Removable Flexible Chisel and Blade Set	177	Schoemaker-Ogilvie Colectomy Forceps	112	Single Hook Retractor	38
Pennybacker Rongeur	80, 126, 127	Resection Knife	194	Schroeder Uterine Vulsellum Forcep	90	Skene Tenaculum Forceps	93
Periosteal Elevator	169, 170	Retractor Suction Tube	124	Schuknecht Instruments	60	Slicing Knife	195
Peters Seigle Speculum	66	Reverdin Suture Needle	182	Schumacher Bone Elevator	171	Small Chisels	160
Petri Dish	41	Rheinstadter Flushing Curette	103	Scissors - Mayo	196	Small Gouges	160
Pilcher Nasal Speculum	67	Rib Knife	195	Scissors	181, 196, 197	Small Mallet	177
Plaster Cutter	147	Rib Shears	199	Scott Stevenson Tonsil Scissors	82	Small Osteotomes	160
Plester-Jansen Retractor	64	Riches Artery Forceps	55	Scott Tonsil Artery Forceps	70	Small Stille Type Mallet	177
Pliers for Bone Burrs	163	Ring Cutter	40	Screw Joint Bone Cutting Forcep	140	Smillie Bone Punch	167
Pliers for Wire	163	Robert Jones Rugine	157	Sellors Rib Approximator and Spreader	224	Smillie Menisectomy Knife	173
Pollock Rib Shears	199	Roberts Artery Forceps	12	Sellors Rib Spreader	224	Snellen Vectis	138
Pooley Conjunctival Scissors	134	Robins Anchoring Forceps	19	SEMB Ligature Passing Clamps	215		
Portmann Aural Scissors	83	Rochester-Mayo Needle Holder	26				
Posterior Bone Lever	172	Rochester-Pean Artery Forceps	12				
Potts Diethrich Scissors	220	Rochester Needle Holder	221				
		Ronald Edwards Rib Spreader	224				

Solid Forged Scalpel	194	Surgical Holdings Orthopaedic Mallet	166
Somer Uterus Holding Forcep	92	Suture/Dissecting Forceps	132
Sommerland Surgical Marking Pen	191	Suture Wire Cutting Scissors	164
Spackman Uterine Cannula	107	Swedish Dissector	118
Spatula Blade	57	Swedish Pattern Chisel	159
Speculum	137	Swedish Pattern Gouge	159
Spencer-Robarts Clamp	90	Swedish Pattern Laminectomy Shears	129
Spencer Wells Artery Forceps	12, 201	Swedish Pattern Osteotome	159
Spinal Chisel	203	Sweet Scissors	117
Spinal Curette	149	Syme Aneurysm Needle	40
Spinal Saw	202	Syme Periosteal Elevator	184
Sponge Holder	210	Syme Tonsil Dissector	86
Spring Bag Clip	30, 138	Sypert Bone Curette	151
Spring Clip	30		
Stammberger Rhinoforcep Antrium Punch	77	<b>T</b>	
Stamms Box Joint Bone Cutter	141	Tarsal Cyst Forceps	133
Stanford Cade Insufflator	88	Teale Uterine Vulsellum Forcep	90
Stanley Boyd Curette	152	Thomas Strabismus Scissors	21, 134
St Bartholomew's Ethmoid Punch	78	Thompson Type Raspatory	167
St Bart's Hook	63	Thompson Walker Bladder Retractor	229
St Bart's Rongeur	80, 126	Thudichum Nasal Speculum	67
St Clair Thompson Dissector	86	Thyroid Scissors	83
St Clair Thompson Nasal Speculum	67	Tibbs Arterial Cannula	227
St Clair Thomson Adenoid Curette	85	Tilley Antrum Burrs	87
Steinmann Pin Cap with Screw	174	Tilley Dressing Forceps	72, 116
Steinmann Pins	174	Tilley Henckel Ethmoid Punch	77
Stevens Tenotomy Scissors	24, 181	Tilley Nasal Gouge	84
Stille Compound Action Bone Rongeur	142	Tilley Septum Gouge	190
Stille Type Plaster Shears	147	Tilley Tonsil Scissors	82
St Mark's Hospital Pattern Retractor	101	Tischler Morgan Biopsy Forcep	95
St Mark's Rectal Dilator	208	Tischler Morgan Biopsy Punch Forcep	95
St Martin Corneal Suturing Forceps	133	Toffee Hammer	166
St Martin Micro Corneal Suturing Forceps	133	Tongue Depressor	75
Stookey Rongeur	127	Tongue Retractor	188
Strabismus Scissors	24, 134, 197	Tooke Knife	138
Stratte Needle Holder	221	Tooth Forceps	51, 52
Struycken Cutting Forceps	69	Tooth Forceps for Children	52
St Thomas Bone Holding Forceps	145	Top and Side Cutter	162
Surgical Holdings Mallet	166	Top Cutter	162

Top Cutting Forceps	53
Tracheal Double Hook	63
Tracheal Hook	63
Tracheal Single Hook Retractor	63
Trautmann Myringotome	85
Travers Retractor	35, 155
Trethowan Bone Lever	153, 172
Treves Dissecting Forceps	15, 200
Trotter Rongeur	127
Trousseau Tracheal Dilator	73
Tubing Mount	88
Tubing Scissors	21
Tudor Edwards Artery Clamps	214
Tudor Edwards Periosteal Elevator	170, 227
Tudor Edwards Retractor	222
Tudor Edwards Rib Shears	226
Tudor Edwards Rib Spreader	225
Tuffier Rib Spreader	225
Tumarkin Atticotomy Elevator	84
Tumarkin Speculum	66
Turner Warwick Diathermy Scissors	55
Turner Warwick Needleholder with Tungsten Carbide Jaws	32
Turner Warwick Retractor Blades	32, 33
Turner Warwick Universal Self Retaining Retractor	32
<b>U</b>	
Umbilical Dilator	108
Umbilical Scissors	106
Unna Comedo Expressor Double Ended Curette	192
Uterine Scissors	106
Utility Scissors	21
<b>V</b>	
Van Doren Biopsy Forceps	96
Van Doren Cervical Biopsy Punch Forcep	97
Vannas Scissors	135
Vant Episiotomy Scissors	106
Vant Uterine Polypus Forcep	92

Vehmhren Rib Holder and Costotome	225
Verbrugge Bone Holding Forceps	146
Vertebrae/Bone Chisel	203
Vertebrae Chisel	203
Volkman Bone Curette	150
Volkman Bone Scoop	152
Volkman Retractor	38

## W

Wagner Bone Elevator	171
Wallace Modified Plester Retractor	64
Wallich Bone Curette	150
Walsham Septum Forceps	71
Walsham Septum Straightening Forceps	183
Walton Bladder Retractor	229
Walton Rectal Biopsy Forceps	206
Ward (East Grinstead) Osteotome	190
Ward Bone Cutting Forceps	141, 183
Warwick-James Elevator	47
Watson-Jones Bone Lever	153
Watson Cheyne Dissector	39, 118
Watson Skin Graft Knife	191
Waugh Dissecting Forceps	15, 187
Weil-Blakesley Rongeur	81
Weitlander Retractor	35
Wells Rib Spreader	225
Wertheim Parametrium Forcep	93
Wertheim Retractor	101
Westcott Scissors	135
West Retractor	35, 155
Wheeler Tonsil Scissors	82
Whitlow Retractor	102
Wilde Dressing Forceps	72
Wilde Entropian Forceps	133
Willet Martel Forceps	94
Williger Bone Curette	150
Wilms Rongeur	127
Wilson Bone Nibbling Forceps	73

Wilson Hey Artery Forceps	55
Wilson Tonsil Scissors	83
Winsbury White Urethral Bougie	230
Winter Elevator	47
Winterton Vaginal Speculum	100
Wire Cutting Pliers	161, 162
Wire Twister Biomet Type	164
Wittner Cervical Biopsy Punch Forcep	97
Woakes Eustachian Catheters	87
Wolf Plaster Spreader	147
Wood Tonsil Scissors	82
Wrigley Obstetric Forcep	98
Wyndham Powell Urethral Bougie	231

**Y**









Yankauer Suction Tube	113
Yeoman Basket	206

**Z**

Zachary Cope Anastomosis Clamp	113
Zoellner Suction Tube	65



## Instrument Sales

-  Surgical Holdings Instruments
-  Symmetry Surgical
-  Hermann Laparoscopic
-  Bissinger Bipolar
-  Light Leads
-  DIN Baskets & Containers
-  Sterile Packed K-Wires
-  Custom-made Instruments

## Refurbish & Repair

-  Surgical Instruments
-  Laparoscopic Instrumentation
-  Electrosurgery Devices
-  Rigid Endoscopes



**Surgical Holdings** Parkside Centre, Temple Farm Ind. Est., Southend-on-Sea, Essex, SS2 5SJ  
E. [info@surgicalholdings.co.uk](mailto:info@surgicalholdings.co.uk) T. +44 (0)1702 602050 F. +44 (0)1702 460006  
[surgicalholdings.co.uk](http://surgicalholdings.co.uk)

