

Jacobson Micro Scissors

Round handle, 1 blade with bead tip, Short fine blades

- 1803221 25° angle, 18cm
- 1803222 45° angle, 18cm
- 1803223 60° angle, 18cm
- 1803224 90° angle, 17.8cm
- 1803225 125° angle, 17.8cm



Potts Style Scissors

Bayonet flat handle, 12mm blades

- 1803302 45° angle, 19cm
- 1803305 125° angle, 18.5cm
- 1803310 125° reverse angle cutting blades (left handed), 18.5cm
- 1803312 45° angle, 1 blade with bead tip, 19cm
- 1803315 125° angle, 1 blade with bead tip, 18.5cm



Jacobson Vannas Micro Scissors

1803031 17cm

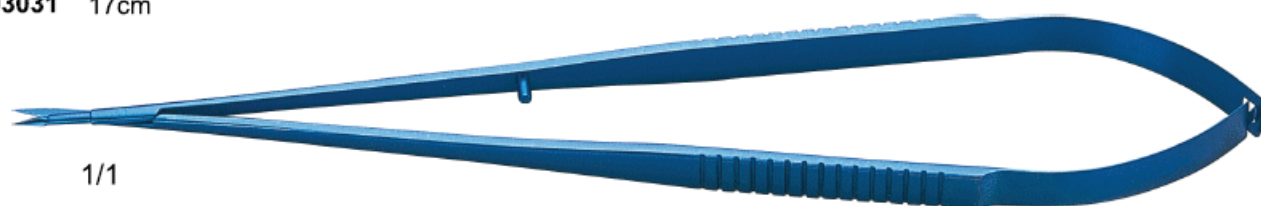

Scissors

Yasargil Micro Scissors

Bayonet flat handle

- 1803341** Straight, 13mm blades, 18.5cm
- 1803341S** Straight, Serrated upper blade, 13mm blades, 18.5cm

- 1803342** Curved, 13mm blades, 18.5cm
- 1803342S** Curved, Serrated upper blade, 13mm blades, 18.5cm

- 1803343** Straight, 14mm blades, 20cm
- 1803343S** Straight, Serrated upper blade, 14mm blades, 20cm

- 1803344** Curved, 14mm blades, 20cm
- 1803344S** Curved, Serrated upper blade, 14mm blades, 20cm

- 1803345** Straight, 15mm blades, 23cm
- 1803345S** Straight, Serrated upper blade, 15mm blades, 23cm

- 1803346** Upwards Curved, 15mm blades, 23cm
- 1803346S** Upwards Curved, Serrated upper blade, 15mm blades, 23cm

- 1803347** Downwards Curved, 15mm blades, 23cm
- 1803347S** Downwards Curved, Serrated upper blade, 15mm blades, 23cm

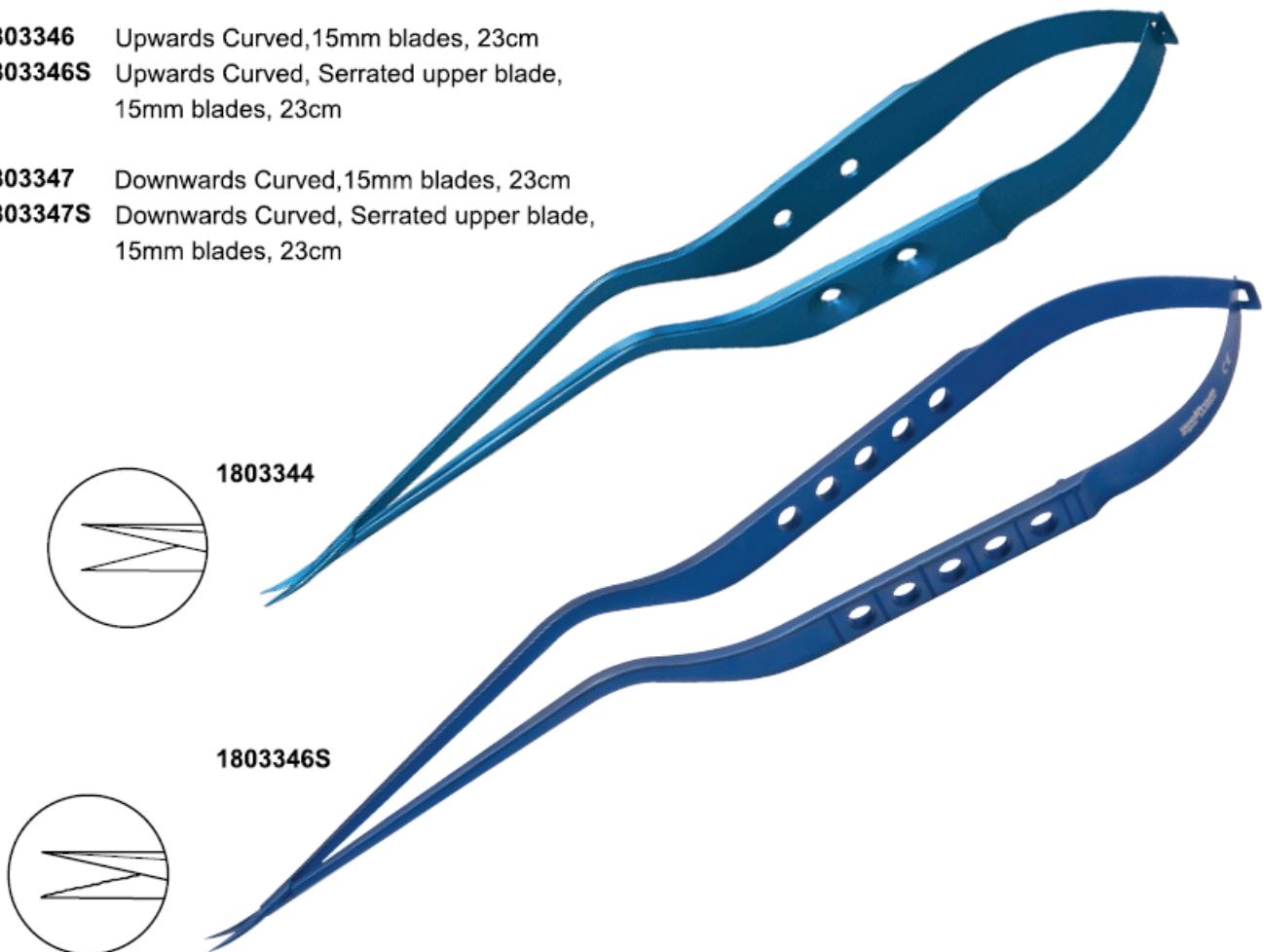

Malis Bayonet Scissors

Flat handle, 23cm

1803351 Straight, Regular tips

1803351S Straight, Regular tips,
Serrated upper blade

1803352 Straight, Fine tips

1803352S Straight, Fine tips,
Serrated upper blade

1803353 Straight, Fine tenotomy tips

1803353S Straight, Fine tenotomy tips,
Serrated upper blade

1803354 Curved up, Regular tips

1803354S Curved up, Regular tips,
Serrated upper blade

1803355 Curved up, Fine tips

1803355S Curved up, Fine tips,
Serrated upper blade

1803356 Curved down, Regular tips

1803356S Curved down, Regular tips,
Serrated upper blade

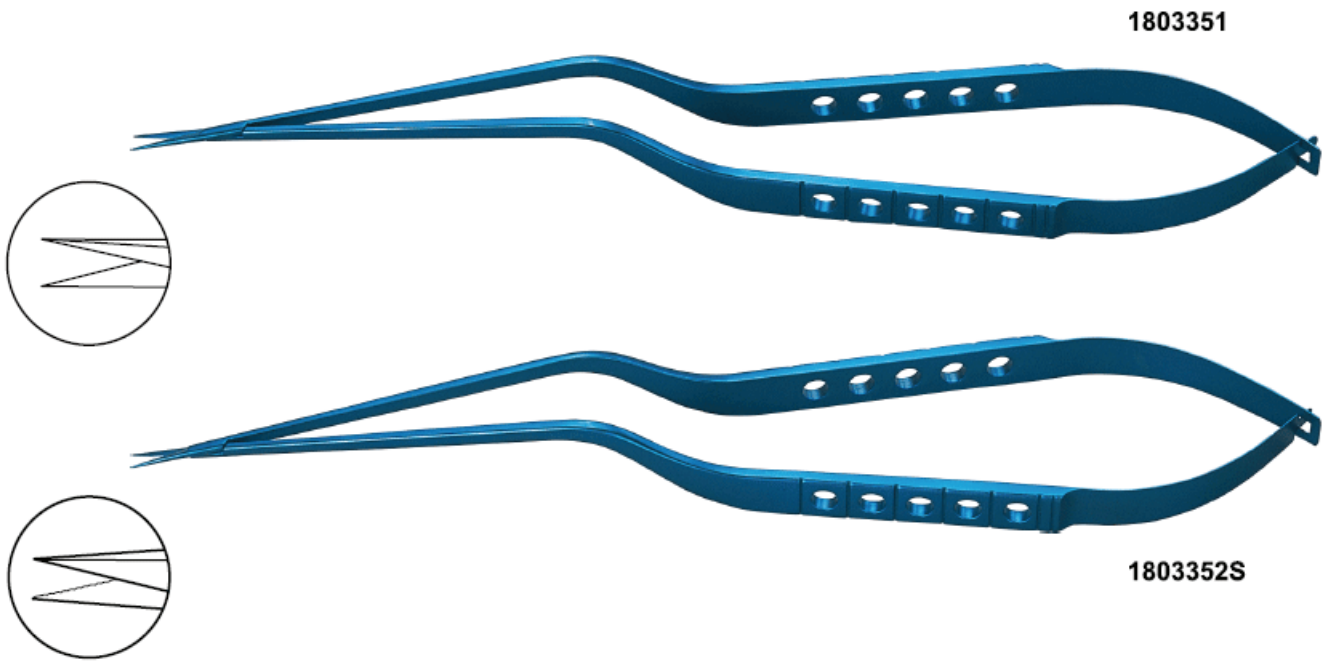

Micro Bayonet Scissors

1803361 Straight, Regular tips, 25.7cm

1803361S Straight, Regular tips,
Serrated upper blade, 25.7cm

1803362 Curved, Regular tips, 25.7cm

1803362S Curved, Regular tips,
Serrated upper blade, 25.7cm

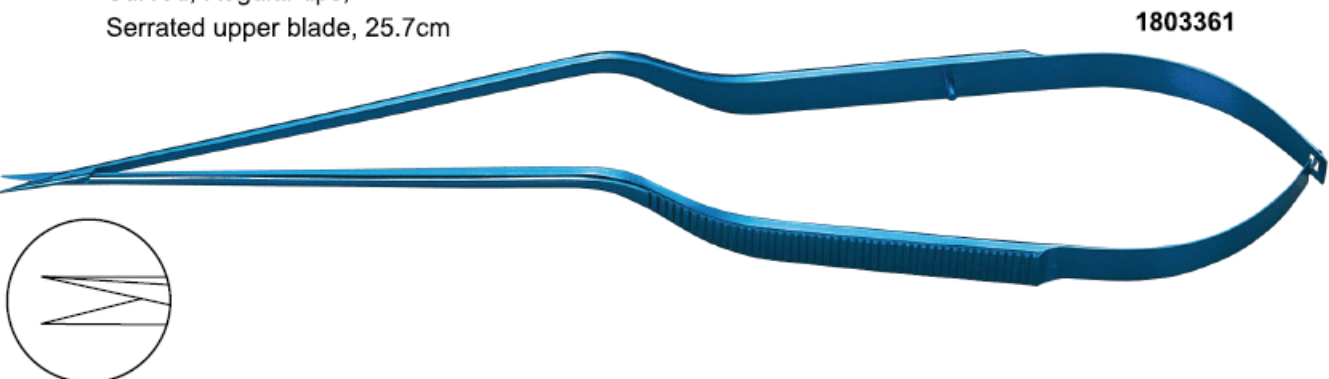

Scissors

Micro Bayonet Scissors

Flat handle, Bayonet style

- 1803371** 5mm blades, Straight, 18.5cm
- 1803372** 5mm blades, Upwards, curved, 18.5cm
- 1803381** 5mm blades, Straight, 22.5cm
- 1803382** 5mm blades, Upwards curved, 22.5cm

1803381



1803382



Malis Bayonet Scissors

Round handle, 23cm

- 1803500** Straight, Regular tips
- 1803500S** Straight, Regular tips, Serrated upper blade
- 1803501** Curved up, Regular tips
- 1803501S** Curved up, Regular tips, Serrated upper blade
- 1803502** Straight, Fine tenotomy tips
- 1803502S** Straight, Fine tenotomy tips, Serrated upper blade

1803500



1803501S

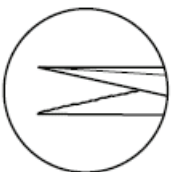

Resano Scissors

With 3 articulations

1800924 24cm

1800928 28cm



Scissors

- 1800930 Plastic-Jabaley Scissors, Straight,12cm
- 1800932 Plastic-Jabaley Scissors, Curved,12cm
- 1800942 Baby Metzenbaum Scissors, Straight,12.5cm
- 1800944 Baby Metzenbaum Scissors, Curved,12.5cm
- 1800947 Metzenbaum Scissors, Straight,18cm
- 1800948 Metzenbaum Scissors, Curved,18cm
- 1800949 Metzenbaum Scissors, Straight, 20cm
- 1800950 Metzenbaum Scissors, Curved, 20cm
- 1800956 Metzenbaum Scissors, Curved, 30.5cm

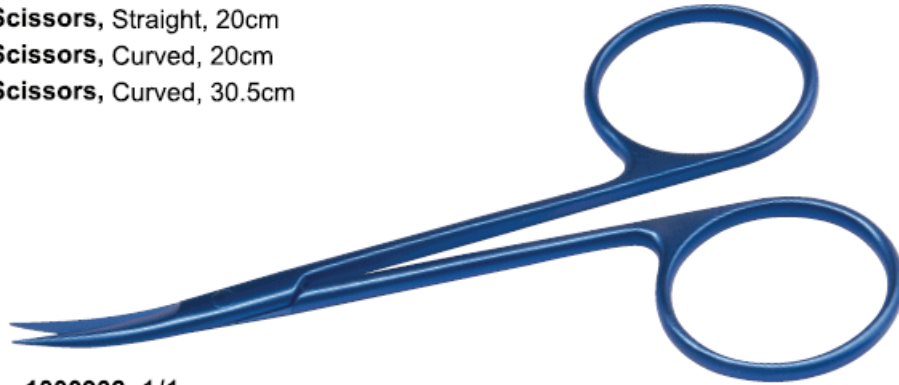

1800932 1/1



1800944 1/1

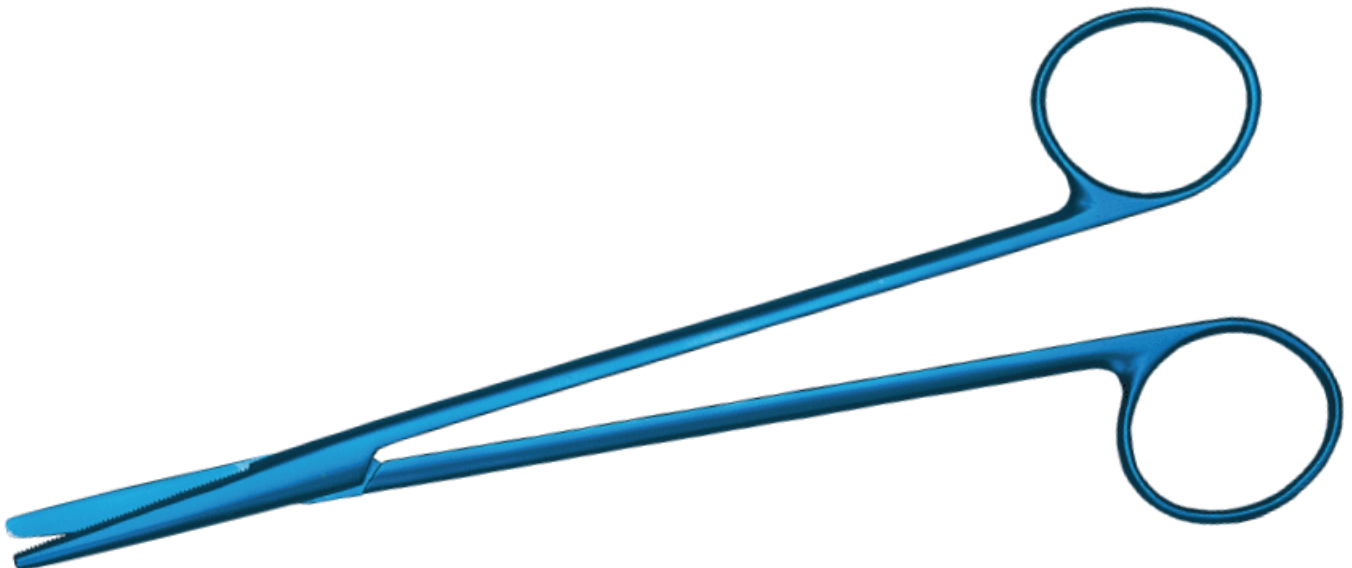

1800947 1/1

Scissors

- 1800962 Mayo Harrington Scissors**
Straight, 20cm
- 1800963 Mayo Harrington Scissors**
Straight, 23cm
- 1800966 Mayo Harrington Scissors**
Curved, 20cm
- 1800972 Mayo Harrington Scissors**
Curved, 30.5cm

1800962 1/1

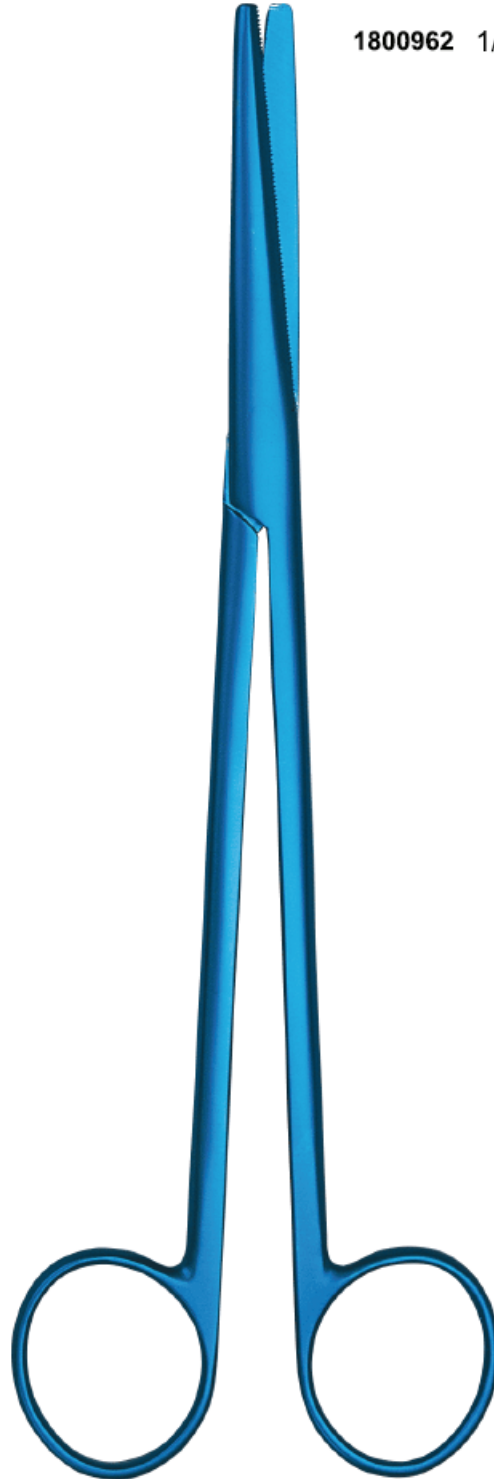

Yasargil Micro Ligature Guide

- 1808401 Slightly curved, 18.5cm
- 1808402 Curved, 18.5cm
- 1808403 90° angled, 18.5cm
- 1808404 135° angled, 18.5cm

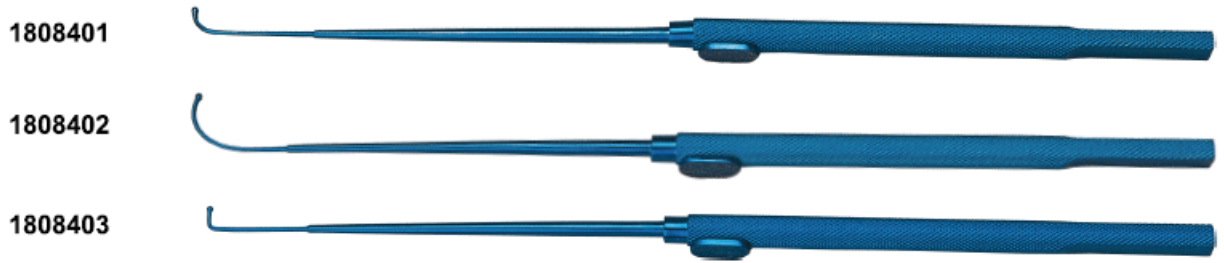

- 1808408 **Jacobson Micro Vessel Knife**, 18.5cm



Yasargil Micro Raspatory

- 1808409 Angled, 18.5cm
- 1808410 Round tip, 18.5cm
- 1808411 Slightly curved, 18.5cm
- 1808412 Curved, 18.5cm

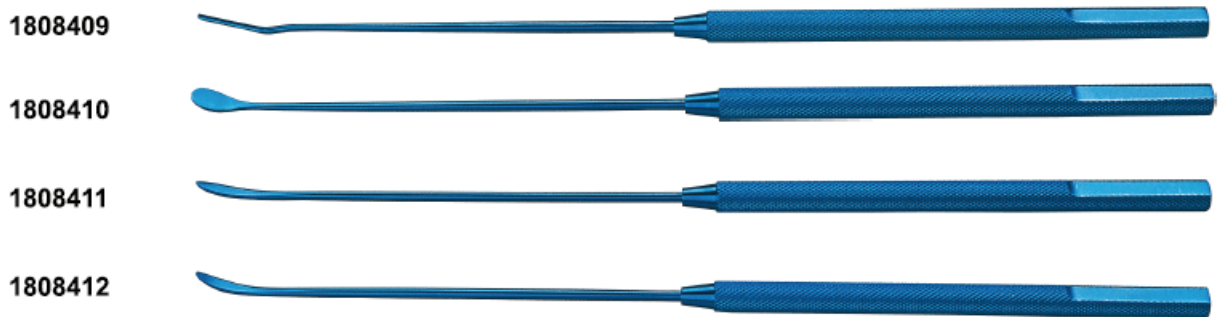

- 1808413 **Yasargil Micro Dissector**, 18.5cm



- 1808414 **Jacobson Micro Probe**, 18.5cm



Dissectors

1808416 **Jacobson Micro Suture Pusher and Knot Tier**,18.5cm



Krayenbuhl Micro Nerve and Vessel Hook

1808418 1.0mm diameter, Hook depth 3mm, Probe pointed small,18.5cm

1808419 1.0mm diameter, Hook depth 3.8mm, Probe pointed large,18.5cm

1808420 Without probe pointed small, Hook depth 2.5mm,18.5cm

1808421 Without probe pointed large, Hook depth 4mm,18.5cm



1808422 **Micro Hooks**,18cm



1808431 **Curette**, 3mm diameter, Straight, 21cm



Micro Vessel Knife

1808700 Bayonet style, Sharp tip,18.5cm

1808701 Bayonet style, Blunt tip,18.5cm

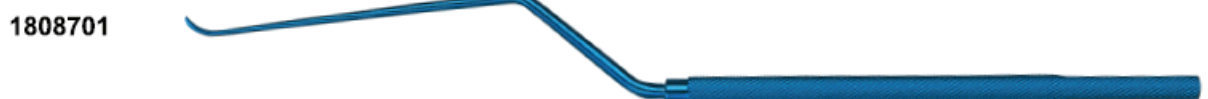
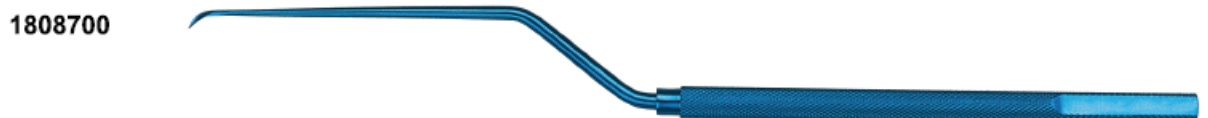

Yasargil Micro Arachnoidea Knife

- 1808702 Upwards curved, 18.5cm
- 1808703 Downwards curved, 18.5cm
- 1808712 Upwards curved, 21.5cm
- 1808713 Downwards curved, 21.5cm

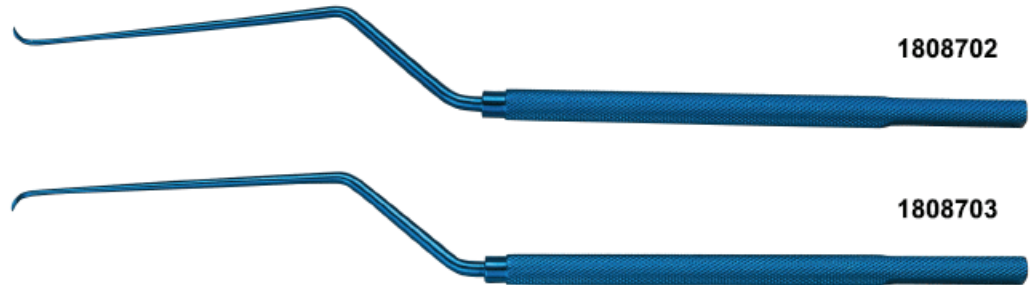

1808715 Bending Hypophysis Enucleator, 22cm



Yasargil Micro Raspatory

Bayonet style

- 1808704 Downwards curved, 18.5cm
- 1808705 Upwards curved, 18.5cm
- 1808706 Slight curved, 18.5cm

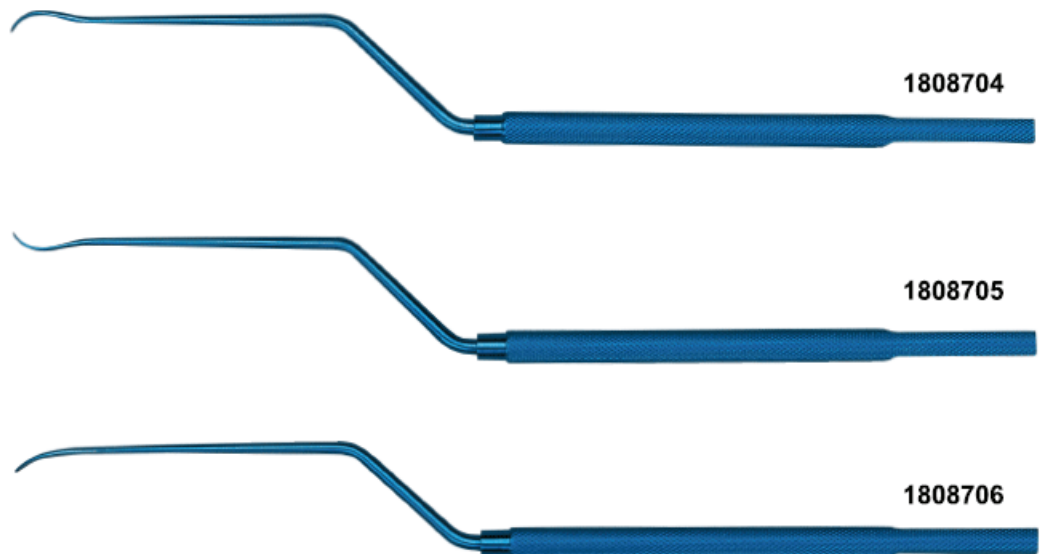

Dissectors

Bayonet Dissector

1808716 1.15mm wide tip, Small, 23cm

1808717 1.7mm wide tip, Medium, 23cm

1808718 2.1mm wide tip, Large, 23cm

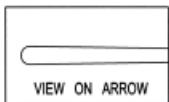
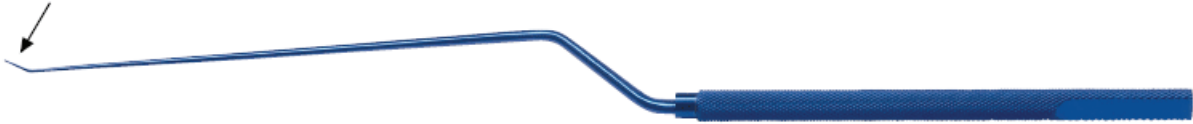

1808716

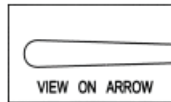

1808717

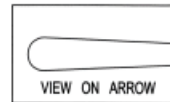

1808718

Bayonet Elevator

1808719 Oval tip, 2.75mm wide, 22.5cm

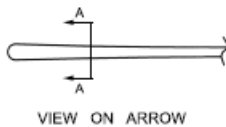

SECTION A-A

Nerve Hook

1808720 Bulbous tip, 23cm

1808721 Angle 90°, 0.5mm tip, 23cm

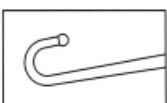

1808720

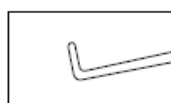

1808721

Curette

Vascular Dilator

Bayonet Curette

- 1808722** Angled up 90°, 3.0mm diameter, 25.5cm
- 1808723** Angled down 90°, 3.0mm diameter, 25.5cm
- 1808724** Angled up 45°, 2.25mm diameter, 25.5cm
- 1808725** Angled up 90°, 3.0mm diameter, 28cm
- 1808726** Angled down 40°, 3.0mm diameter, 28cm
- 1808727** Angled up 45°, 2.25mm diameter, 28cm



Garrett Vascular Dilator

Malleable shaft

- 1808748A** 0.5mm, 14cm
- 1808748B** 1.25mm, 14cm
- 1808748C** 1.75mm, 14cm
- 1808748D** 2.0mm, 14cm

- 1808749A** 0.5mm, 21cm
- 1808749B** 1.25mm, 21cm
- 1808749C** 1.75mm, 21cm
- 1808749D** 2.0mm, 21cm

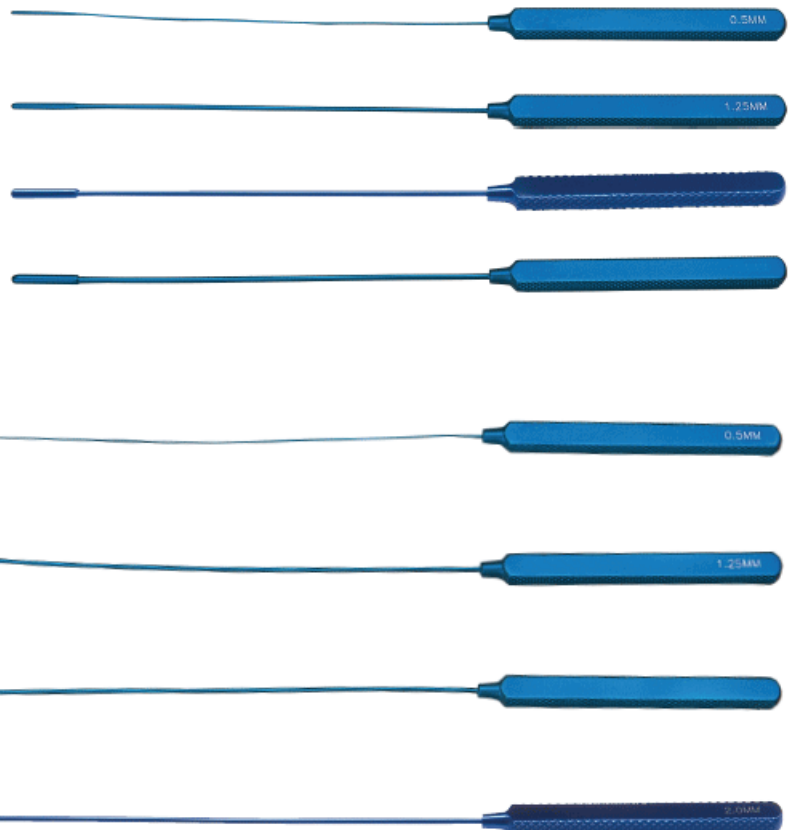

Vascular Hook

Retractor

Carpentier Vascular Hook

1808845 Angle 45°

1808890 Angle 90°

1808925 Angle 125°

1808845



1808890



1808925



I.M.A Epicardial Retractor

1874047 47mm

1874063 54mm



1874063 1/1

1822200 Wood Double Ended Retractors

Blade A: 28mm D × 20mm W,

Blade B: 40mm D × 20mm W,

Overall length 315mm

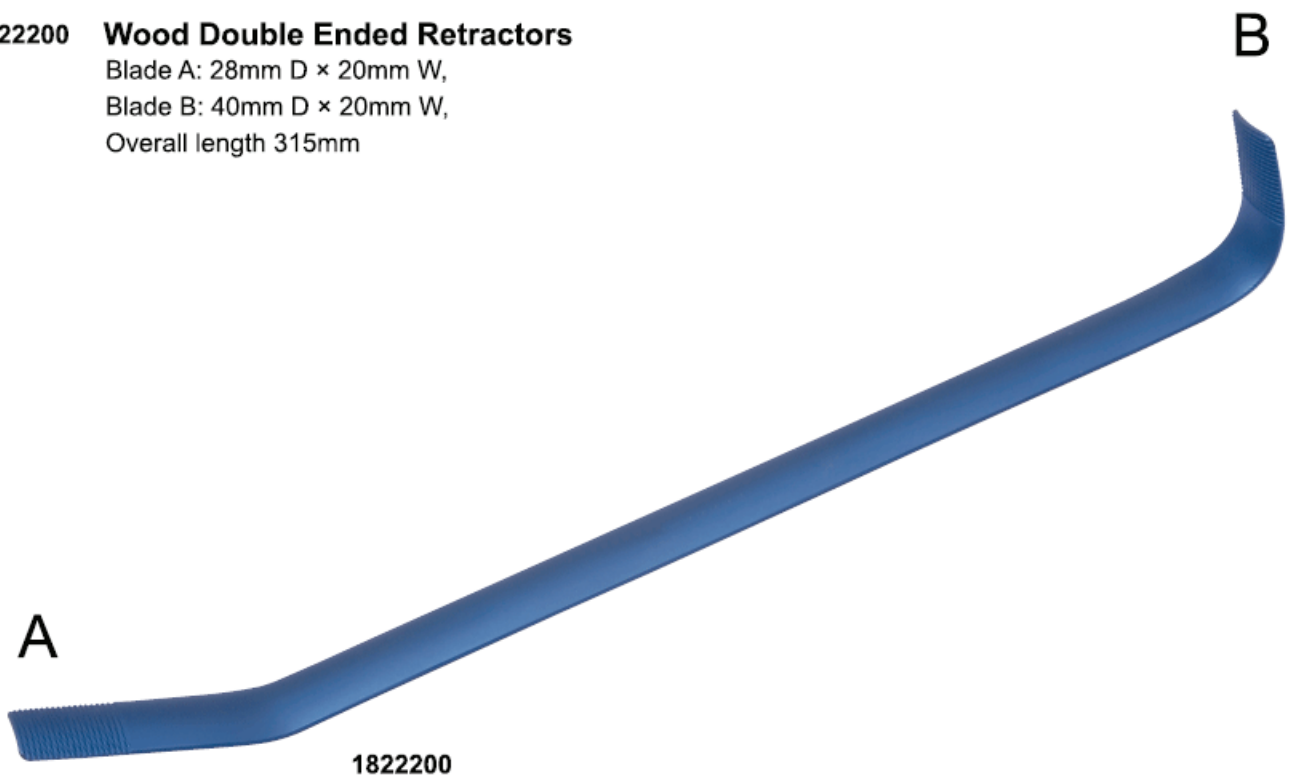

1822200

Retractor

Valve Mitral Retractor

- 1822236 Large, Platypus, 36mm blade width, 27cm
- 1822221 Medium, Platypus, 23mm blade width, 25.5cm
- 1822231 Small, Platypus, 23mm blade width, 23.5cm

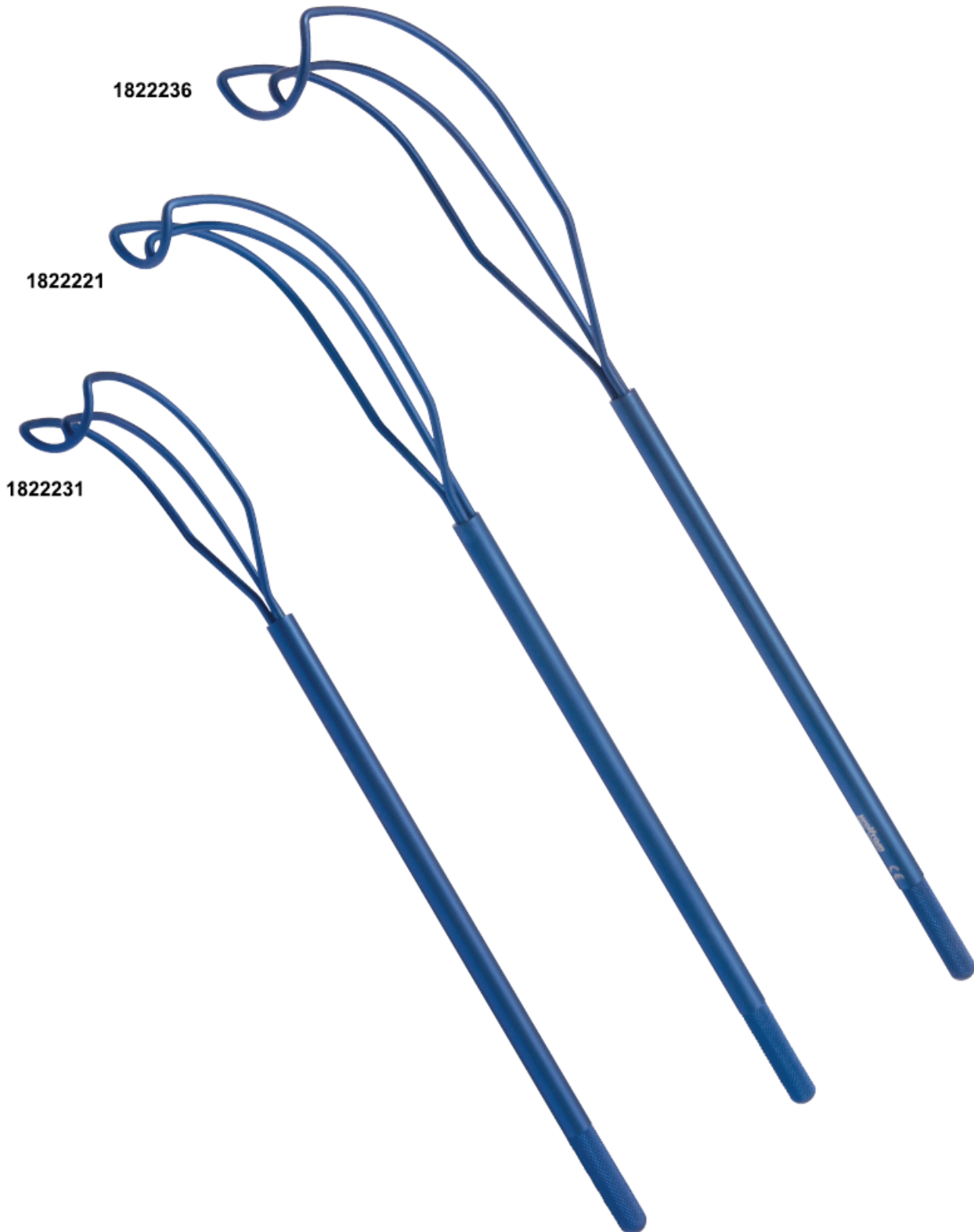

Retractor

- 1874043 Pediatric Sternal Retractor**
With interchangeable blades (2 pair), Arm length 52mm

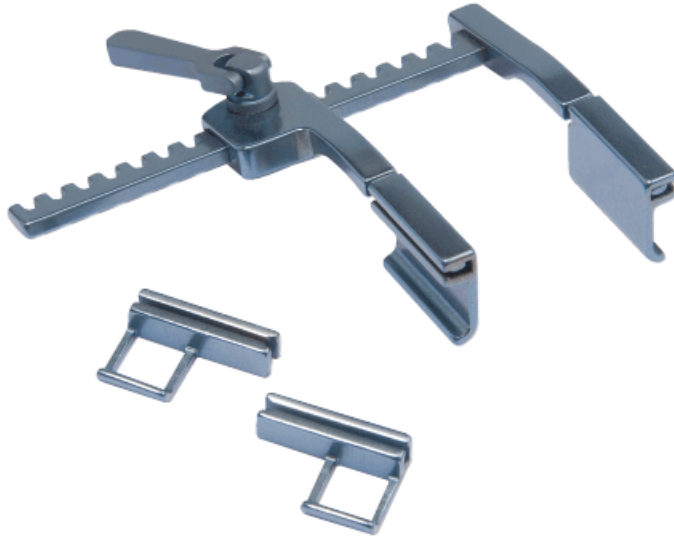

- 1874083 Finochietto Sternal Retractor**
Arm length 52mm



Retractor

1874065 Sternal Retractor

Blades 12mm D × 25mm W,
Arm length 83mm

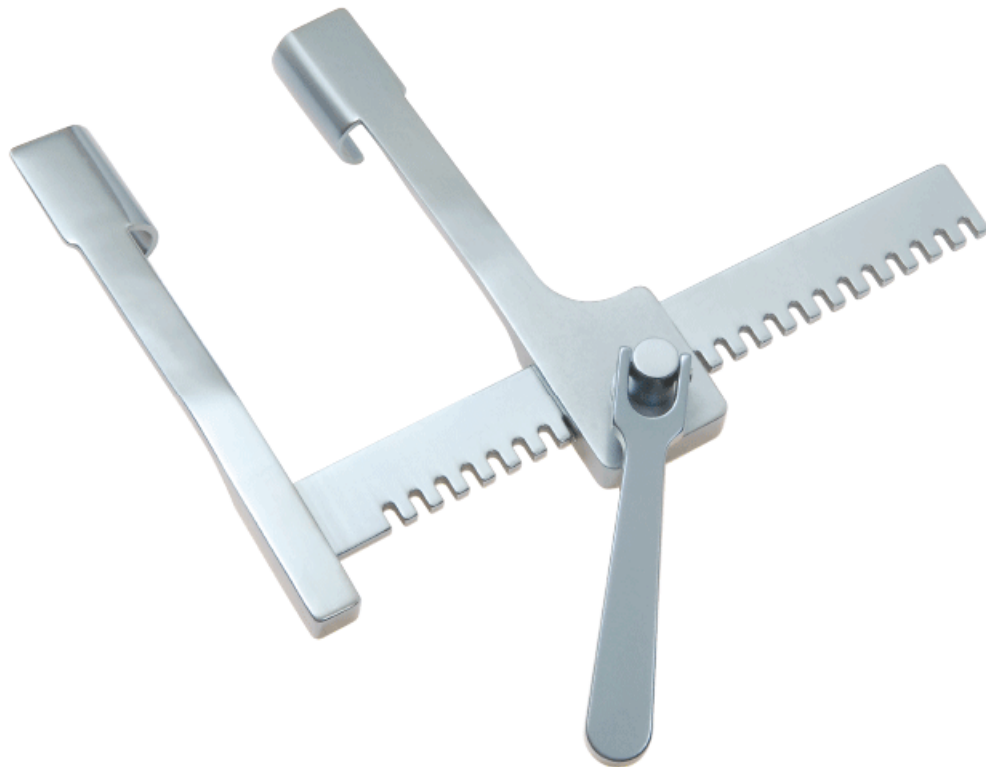

1874028 Haight-Finochietto Rib Retractor

Blades 30mm D × 32mm W,
Arm length 83mm

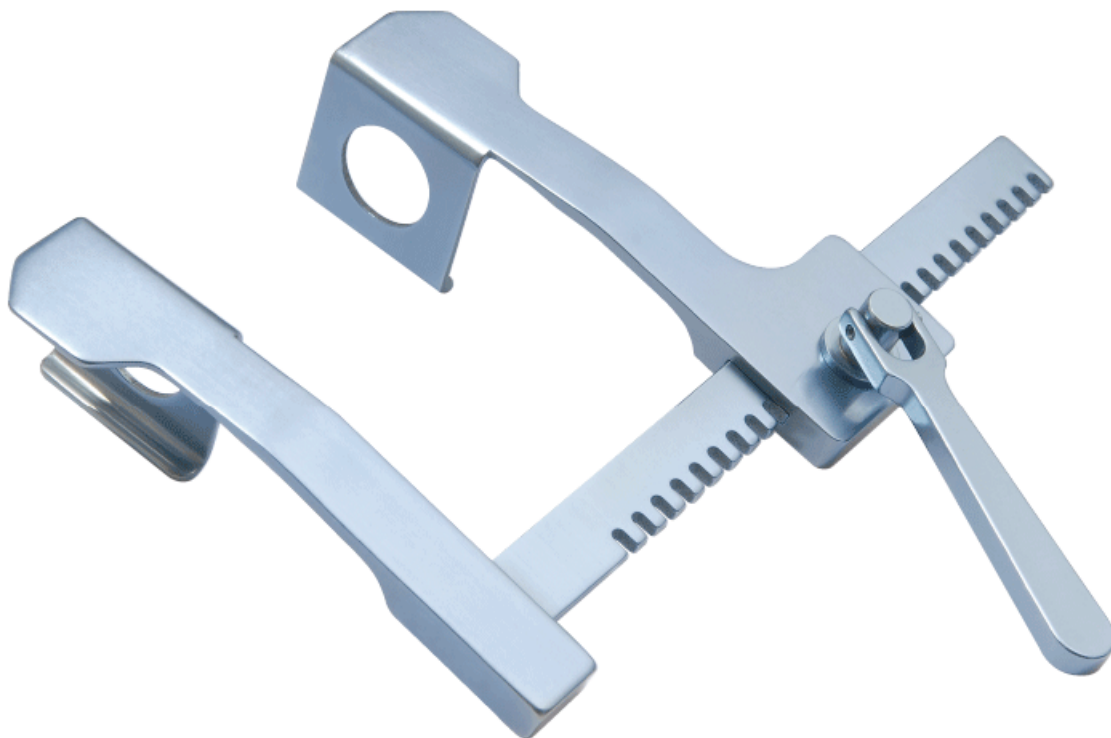

Retractor

More Sternal Retractor

1874066 Child size

Total opening	160mm
Blade width	19mm
Blade depth	19mm
Arm length	156mm

1874067 Adult size

Total opening	200mm
Blade width	28mm
Blade depth	25mm
Arm length	200mm

1874090 Adult size

Total opening	200mm
Blade width	28mm
Blade depth	38mm
Arm length	200mm

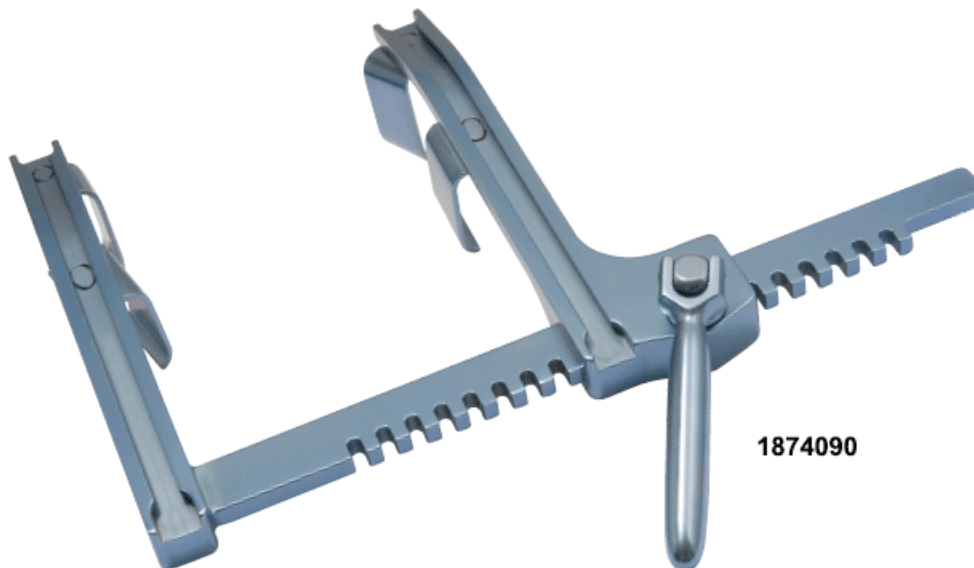
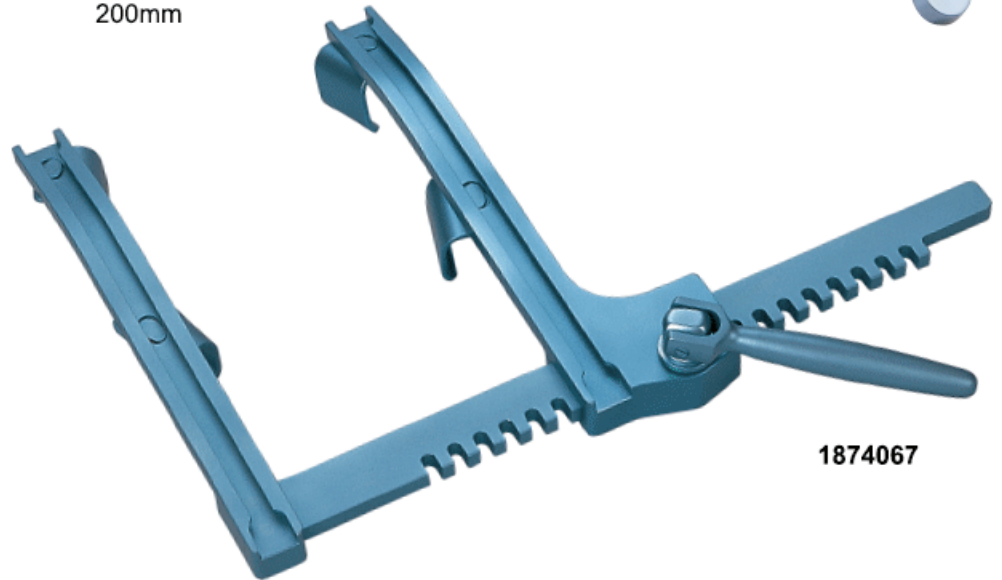
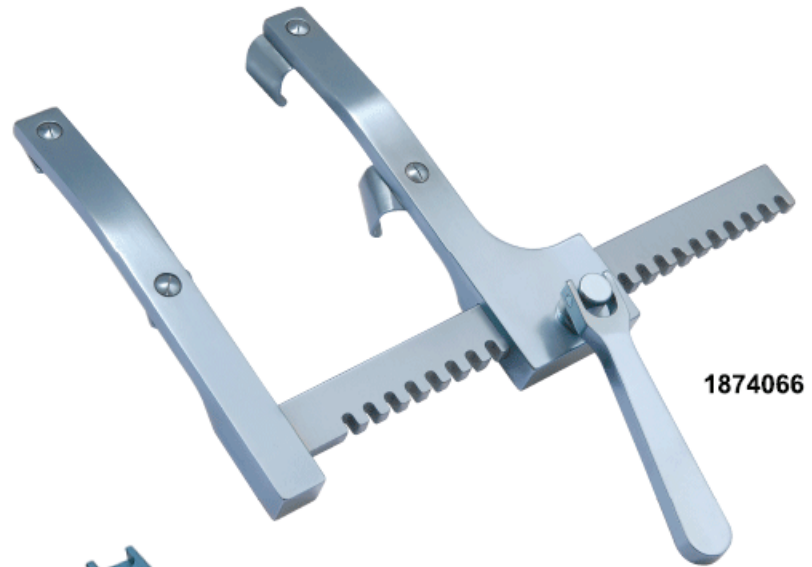

Retractor

1874170 Dubost Thoracic Retractor

Arm length 185mm, Curved, with interchangeable blades (3 pair)

Consists of:

74170-30 Small blade

74170-40 Medium blade

74170-50 Medium blade

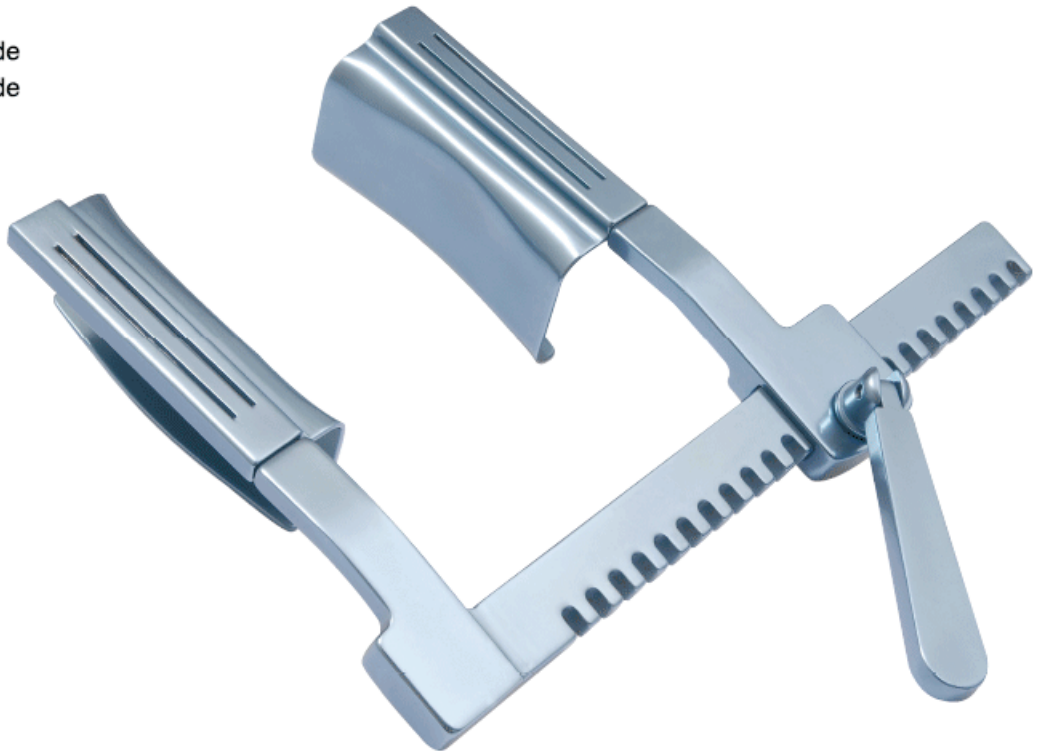

74170-30

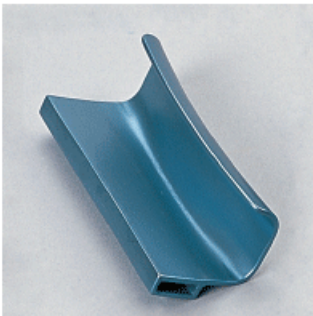

74170-40

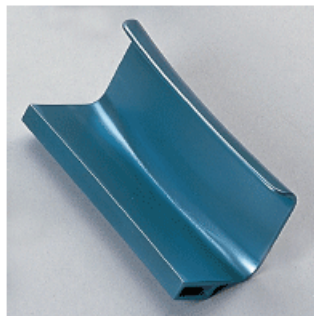

74170-50

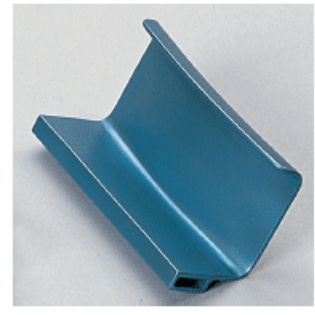
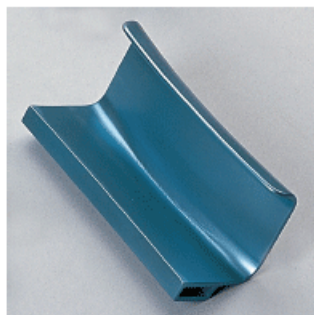
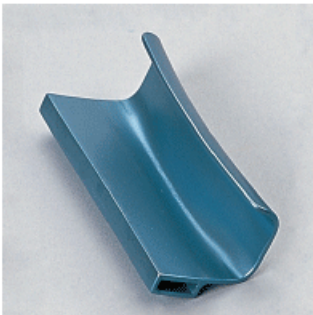
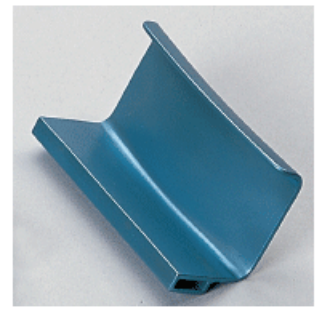

Retractor

1874211 **Carpentier Mitral Valve Retractor**

Arm length is 200mm, Curved

Consists of:

- 74211-15** 15mm malleable narrow blade
- 74211-25** 25mm malleable wide blade
- 74255-00** Median blade with slider

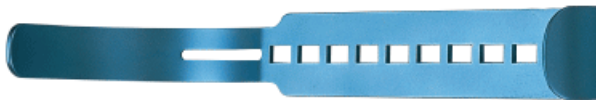
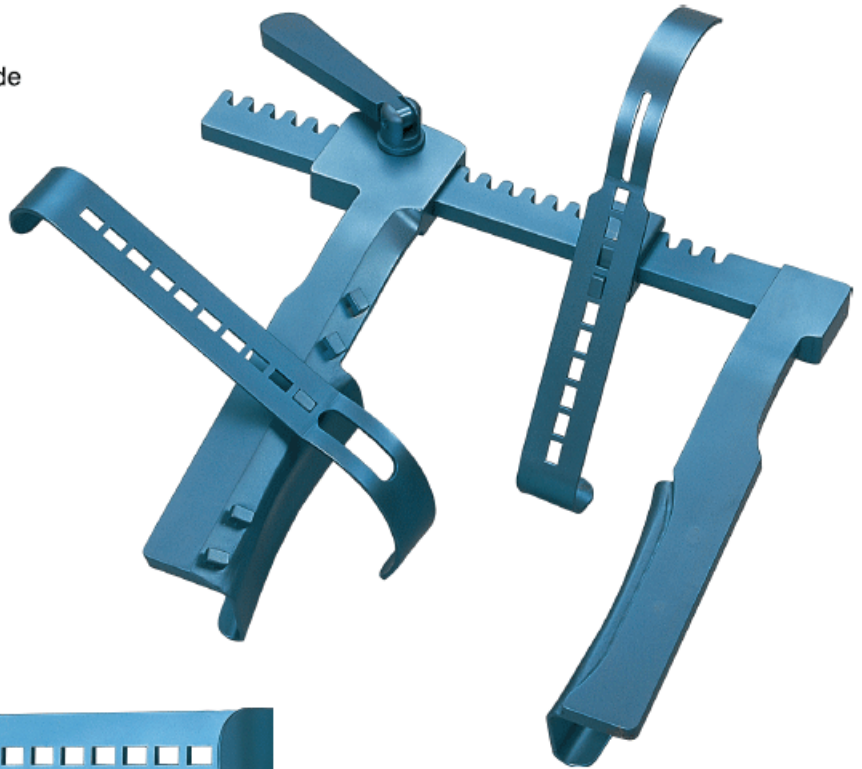

74211-15



74211-25



74255-00

Retractor

1874252 Sternal-IMA Retractor

Arm length 170mm

Consists of:

- 74252-20 20mm blades
- 74252-25 25mm blades
- 74252-28 28mm hooks
- 74252-32 32mm hooks
- 74252-38 38mm hooks

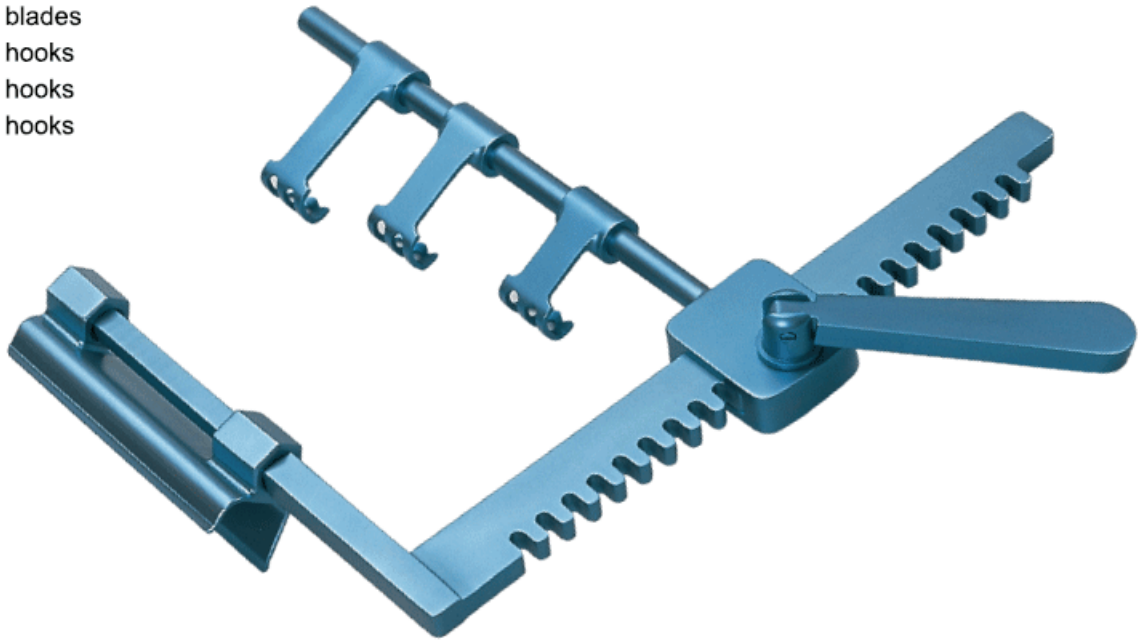

74252-20

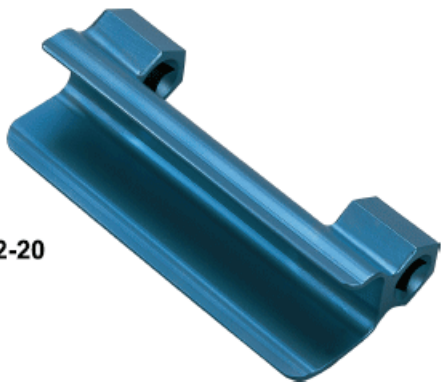

74252-28



74252-32

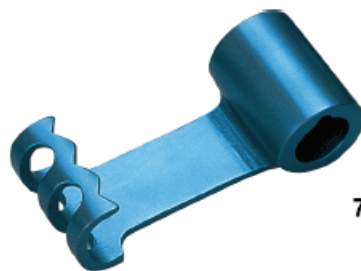

74252-25



74252-38

