



Thoracic

Artery Clamps	212
Clamps	214
Bulldog Clamps	219
Scissors	220
Needle Holders	221
Retractors	222
Rib Spreaders	223
Rib Shears	226
Lung Forceps	226
Elevators	227
Miscellaneous	227

Artery Clamps

An Overview On

Atraumatic Jaws

Also known as non-traumatic, atraumatic jaws will be mainly found in delicate surgery areas such as vascular and cardiothoracic. The design is such, that the surface area gripped is reduced, ensuring less trauma without the loss of grip.

Atraumatic jaws are available as straight or curved.

Atraumatic Jaw, Straight



Atraumatic Jaw, Curved



Cooley Artery Clamps

Box joint, atraumatic, curved

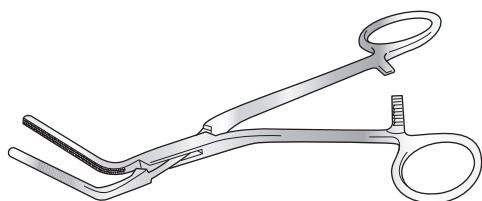

Code	Description
SC-GI/071	160mm long
SC-GI/072	200mm long

Large, curved 60°

Code	Description
SC-GI/073	150mm long

Large, strongly curved 90°

Code	Description
SC-GI/074	140mm long

Curved 30°

Code	Description
SC-GI/075	160mm long

DeBakey Bainbridge Clamps

Box joint, atraumatic, haemostatic

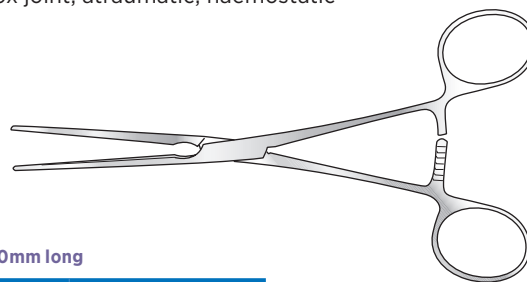

180mm long

Code	Description
SC-GI/078	Straight
SC-GI/077	Curved

DeBakey Bainbridge Clamps

Box joint, atraumatic

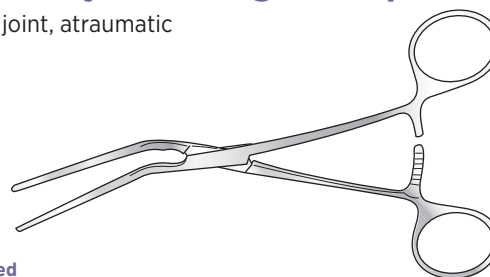

Curved

Code	Description
SC-GI/079	165mm long

DeBakey Bainbridge Clamps

Box joint, atraumatic, haemostatic

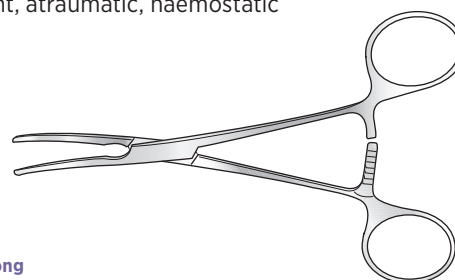

155mm long

Code	Description
SC-GI/105	Curved
SC-GI/106	Straight

DeBakey Clamps

Box joint, atraumatic

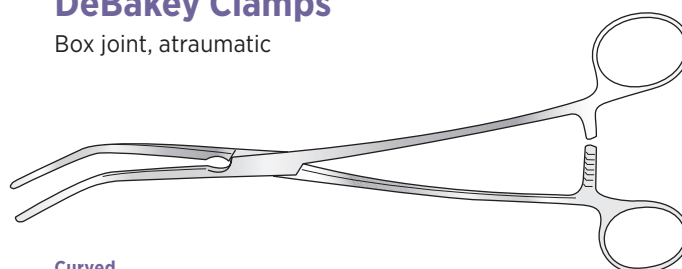

Curved

Code	Description
SC-GI/086	230mm long

DeBakey Clamps

Box joint, atraumatic

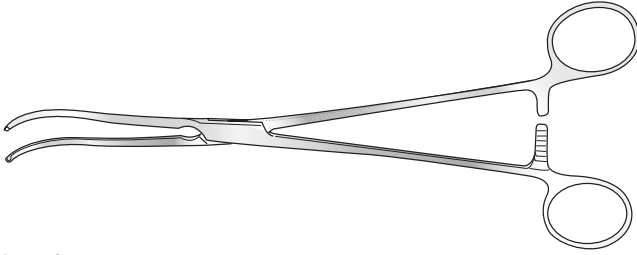

Curved

Code	Description
SC-GI/088	230mm long
SC-GI/089	240mm long
SC-GI/090	245mm long

DeBakey Clamps

Box joint, atraumatic

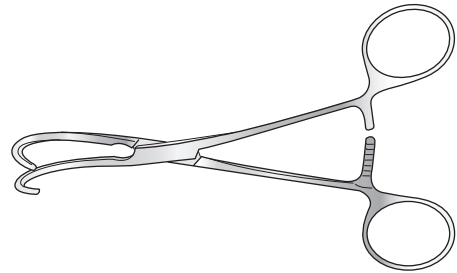

Curved

Code	Description
SC-GI/094	150mm long

DeBakey Clamps

Box joint, atraumatic

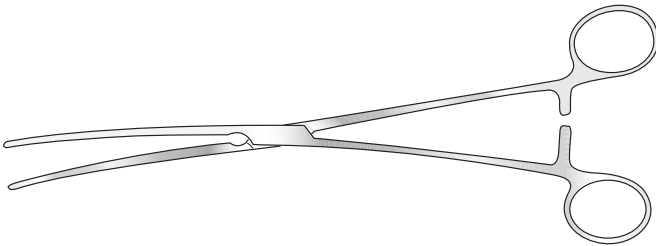

Curved

Code	Description
SC-GI/091	250mm long
SC-GI/092	270mm long
SC-GI/093	280mm long

DeBakey Clamps

Box joint, atraumatic

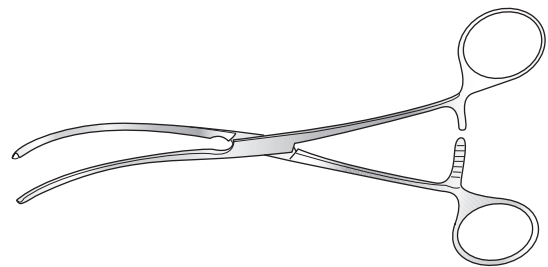

Curved

Code	Description
SC-GI/096	180mm long
SC-GI/097	203mm long

DeBakey Clamps

Box joint, atraumatic, straight

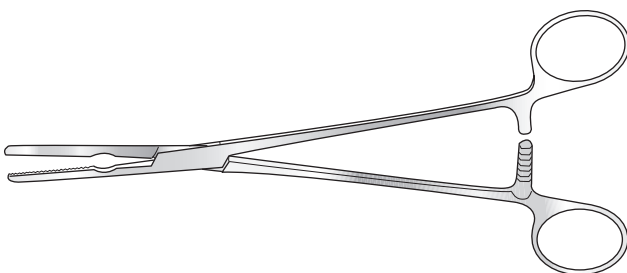

Curved

Code	Description
SC-GI/100	160mm long
SC-GI/104	165mm long
SC-GI/101	203mm long
SC-GI/098	215mm long
SC-GI/102	220mm long
SC-GI/103	230mm long
SC-GI/099	245mm long

DeBakey Clamps

Box joint, atraumatic

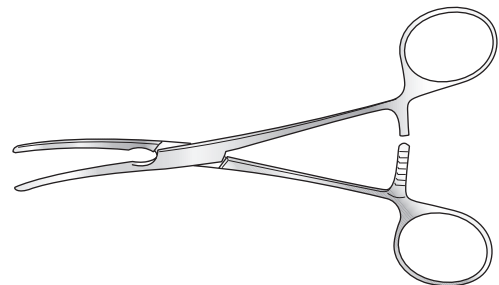

Curved

Code	Description
SC-GI/080	165mm long
SC-GI/081	190mm long
SC-GI/082	203mm long
SC-GI/083	215mm long
SC-GI/084	220mm long

Clamps

Duval Lung Grasping Clamps

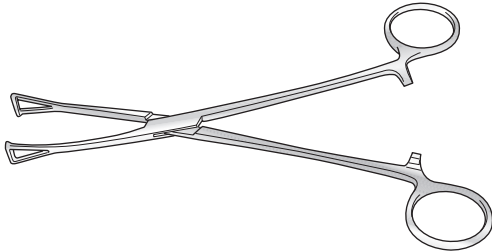

Code	Description
SC-THO/033	185mm long

Tudor Edwards Artery Clamps

Curved, serrated jaws, screw joint, satin finish

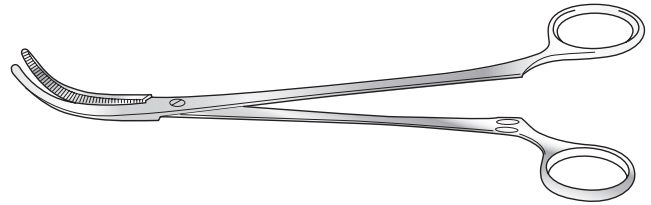

Code	Description
SC-THO/015	230mm long

Babcock Lung Grasping Clamps

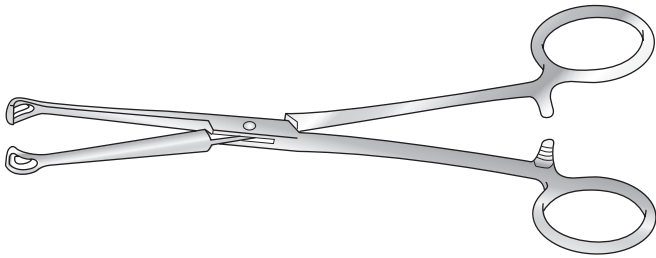

Code	Description
SC-THO/034	245mm long

O'Shaughnessy Artery Clamps

Right angled serrated jaw

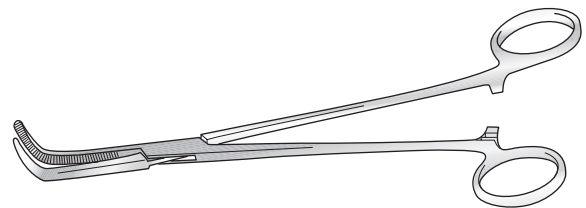

Code	Description
SC-THO/036a	150mm long
SC-THO/036b	180mm long
SC-THO/036c	200mm long
SC-THO/036d	230mm long

Surgical Holdings now offer a VATS range of instruments through Reuchlen

Order now by emailing info@surgicalholdings.co.uk



DeBakey Atraumatic Dissecting Clamps

Straight, atraumatic jaws

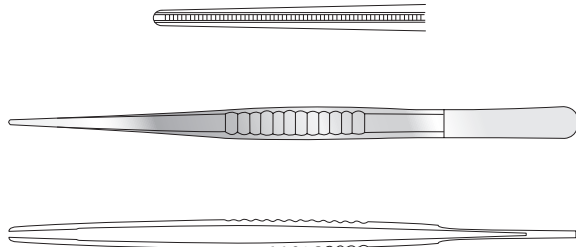

1.5mm

Code	Description
SC-GI/238a	150mm long
SC-GI/240a	240mm long

2.5mm

Code	Description
SC-GI/238b	150mm long
SC-GI/240b	240mm long

2mm

Code	Description
SC-GI/238	150mm long
SC-GI/241	180mm long

2.8mm

Code	Description
SC-GI/238c	150mm long
SC-GI/240c	240mm long
SC-GI/241c	180mm long

Magill Intratracheal Catheter Clamps

Screw joint

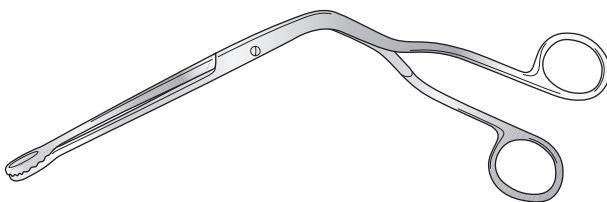

Code	Description
SC-THO/032	Infant, 160mm long
SC-THO/032a	Child, 190mm long
SC-THO/032b	Adult, 230mm long

SEMB Ligature Passing Clamps

240mm long

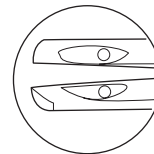
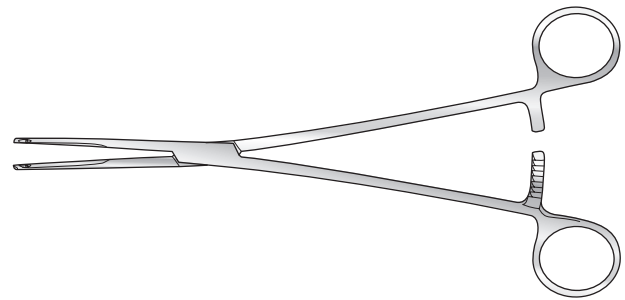

Code	Description
SC-THO/044	Slightly curved
SC-THO/045	Fully curved

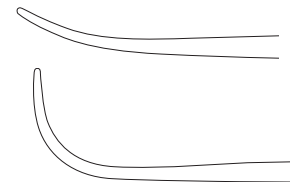

Lambert-Kay Clamp

Atraumatic

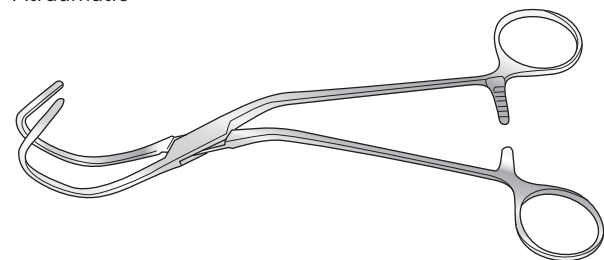

Code	Description
SC-THO/029a	Curved, 220mm long
SC-THO/029b	Straight, 215mm long
SC-THO/029c	Straight, 200mm long

Leland-Jones Clamp

Atraumatic, hemostatic

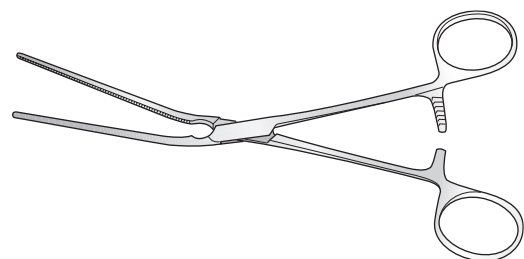

Code	Description
SC-THO/023a	Curved, 190mm long
SC-THO/023b	Straight, 195mm long

Clamps

DeBakey Clamp

Straight jaws, ring handle

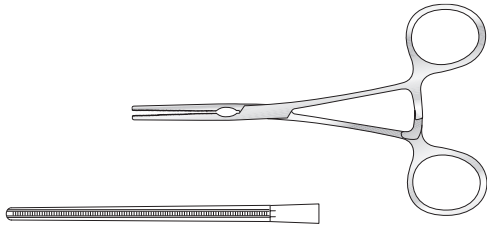

Code	Description
SC-THO/048	137mm long

DeBakey Clamp

'S' shaped curved jaws, curved shaft, ring handle

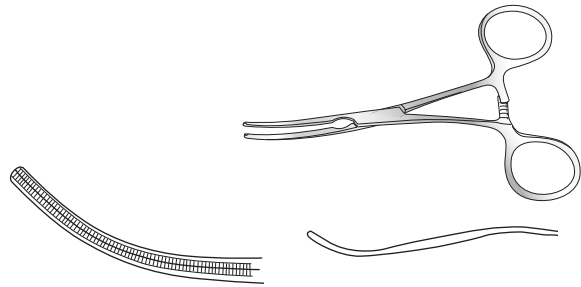

Code	Description
SC-THO/049	127mm long

DeBakey "S" Shaped Clamp

300mm long

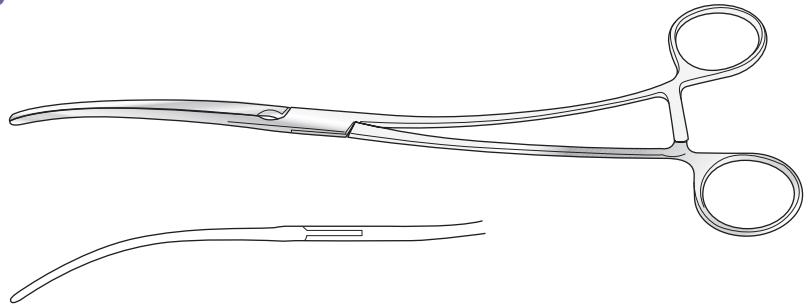

Code	Description
SC-THO/096	115mm jaws

DeBakey Atraumatic Clamp

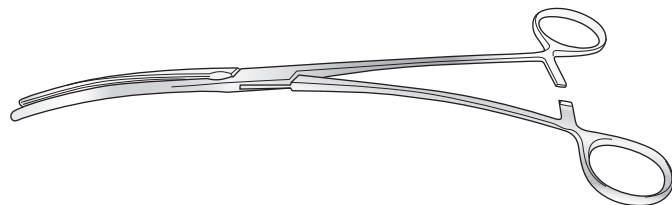

Code	Description
SC-THO/090	110mm jaw, 300mm long
SC-THO/092	95mm jaw, 250mm long

DeBakey Atraumatic Clamp

Right-angled, 40mm jaw

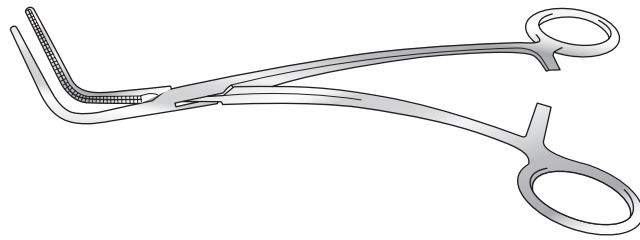

Code	Description
SC-THQ/044a	220mm long

DeBakey Atraumatic Clamp

Right-angled, 50mm jaw

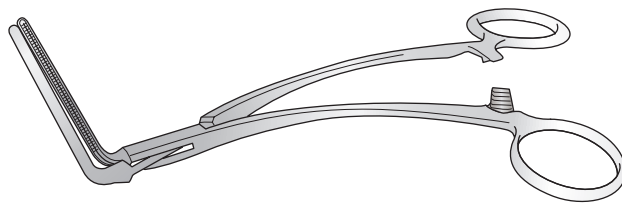

Code	Description
SC-THQ/045	200mm long

DeBakey Atraumatic Clamp

Right-angled, 65mm jaw

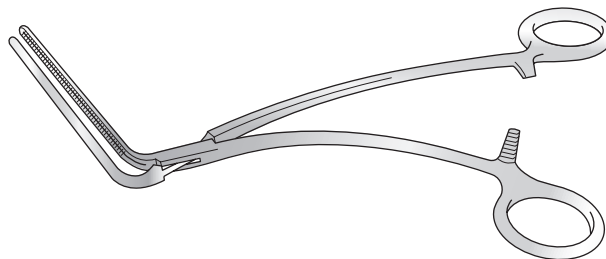

Code	Description
SC-THQ/046	215mm long

DeBakey Atraumatic Clamp

Right-angled, 100mm jaw

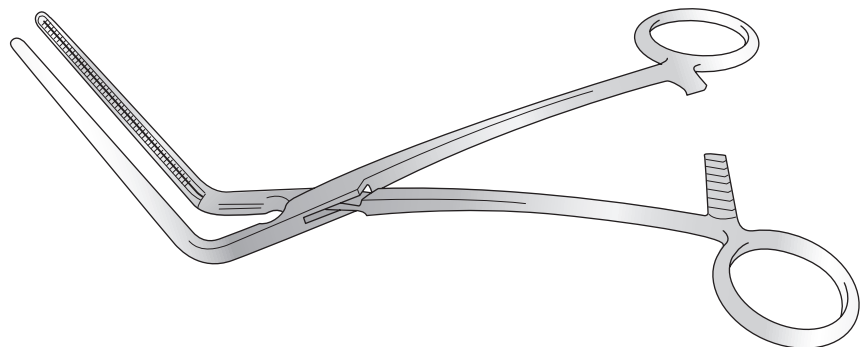

Code	Description
SC-THQ/047	280mm long

Clamps

DeBakey Coarctation Clamp

Angled, 225mm long

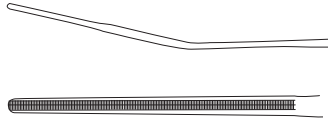

Code
SC-THO/052

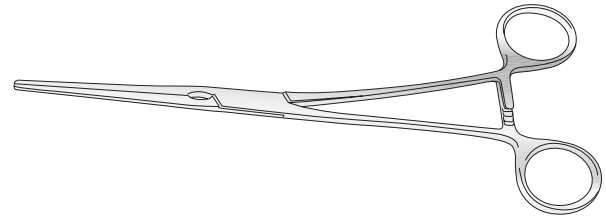

DeBakey Multipurpose Clamp

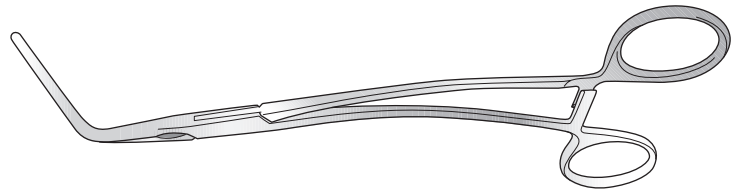
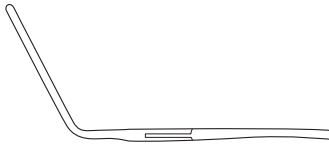

Code	Description
SC-THO/095	85mm jaw, 230mm long
SC-THO/064	100mm jaw, 280mm long

DeBakey Multipurpose Clamp

Obtuse angled 60°, 280mm long

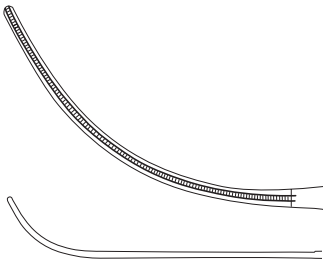

Code
SC-THO/053

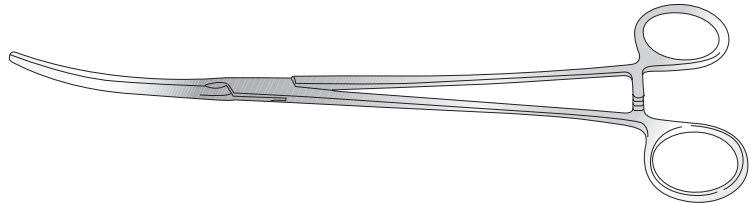

DeBakey 45° Paediatric Clamp

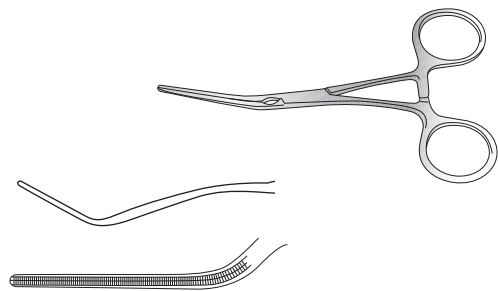

Code	Description
SC-THO/050	130mm long

DeBakey 90° Paediatric Clamp

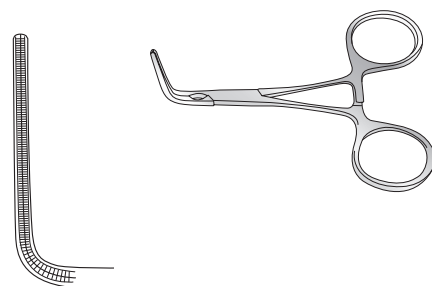

Code	Description
SC-THO/051	105mm long

Dieffenbach Bulldog Clamp

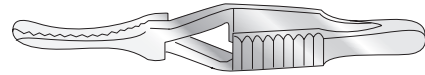
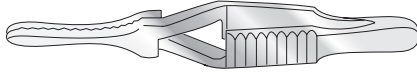

Straight, serrated

Code	Description
SC-GI/112	1.2mm fine jaw, 40mm long
SC-GI/113	1.2mm fine jaw, 45mm long
SC-GI/108	1.8mm jaw, 30mm long
SC-GI/109	1.8mm jaw, 35mm long
SC-GI/110	2.5mm jaw, 40mm long
SC-GI/111	2.5mm jaw, 45mm long
SC-GI/107	6mm heavy jaw, 60mm long
SC-GI/455	20mm jaw, 75mm long
SC-GI/455a	30mm jaw, 85mm long
SC-GI/455b	45mm jaw, 105mm long
SC-GI/455c	65mm jaw, 120mm long

Straight, plain

Code	Description
SC-GI/129	1.2mm fine jaw, 40mm long
SC-GI/131	1.2mm fine jaw, 45mm long
SC-GI/121	1.8mm jaw, 30mm long
SC-GI/123	1.8mm jaw, 35mm long
SC-GI/125	2.5mm jaw, 40mm long
SC-GI/127	2.5mm jaw, 45mm long

Curved, serrated

Code	Description
SC-GI/119	1.2mm fine jaw, 40mm long
SC-GI/120	1.2mm fine jaw, 45mm long
SC-GI/115	1.8mm jaw, 30mm long
SC-GI/116	1.8mm jaw, 35mm long
SC-GI/117	2.5mm jaw, 40mm long
SC-GI/118	2.5mm jaw, 45mm long
SC-GI/114	6mm heavy jaw, 60mm long
SC-GI/456	20mm jaw, 75mm long
SC-GI/456a	30mm jaw, 85mm long
SC-GI/456b	45mm jaw, 105mm long
SC-GI/456c	65mm jaw, 120mm long

Curved, plain

Code	Description
SC-GI/130	1.2mm fine jaw, 40mm long
SC-GI/132	1.2mm fine jaw, 45mm long
SC-GI/122	1.8mm jaw, 30mm long
SC-GI/124	1.8mm jaw, 35mm long
SC-GI/126	2.5mm jaw, 40mm long
SC-GI/128	2.5mm jaw, 45mm long

Blalock Bulldog Clamp

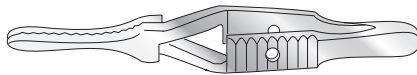

Serrated, with hole in handle

Straight

Code	Description
SC-GI/480	11mm jaw, 38mm long
SC-GI/482	14mm jaw, 48mm long
SC-GI/493	17mm jaw, 60mm long
SC-GI/481	27mm jaw, 70mm long

Curved

Code	Description
SC-GI/478	11mm jaw, 38mm long
SC-GI/479	14mm jaw, 48mm long
SC-GI/491	17mm jaw, 60mm long
SC-GI/492	27mm jaw, 70mm long

Diethrich Bulldog Clamp

Angled 12mm jaw

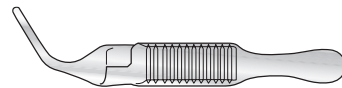

Code	Description
SC-JD-GI/8097	44mm long

Plain, with hole in handle

Straight

Code	Description
SC-GI/486	11mm jaw, 38mm long
SC-GI/487	14mm jaw, 48mm long
SC-GI/488	17mm jaw, 60mm long
SC-GI/489	27mm jaw, 70mm long

Curved

Code	Description
SC-GI/483	11mm jaw, 38mm long
SC-GI/484	14mm jaw, 48mm long
SC-GI/485	17mm jaw, 60mm long
SC-GI/490	27mm jaw, 70mm long

Scissors

i FOR INFORMATION ON BLACK AND GOLD BOWS SEE PAGE 23

Potts Scissors

Satin finish, 190mm long

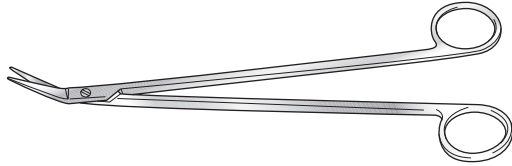

Code	Description
SC-THO/019	Angled on flat 45°
SC-THO/020a	Angled to side 45°
SC-THO/020b	Acute angle to side

Potts Diethrich Scissors

Supercut, 190mm long

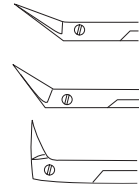
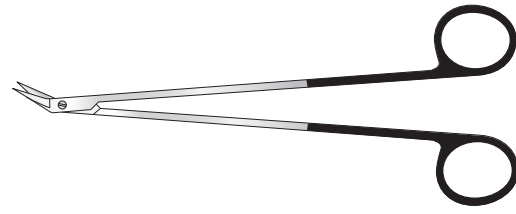

Code	Description
SC-THO/078	25° angled on side
SC-THO/079	45° angled on side
SC-THO/080	90° angled on side

Diethrich Circumflex Artery Scissors

Supercut, 175mm long

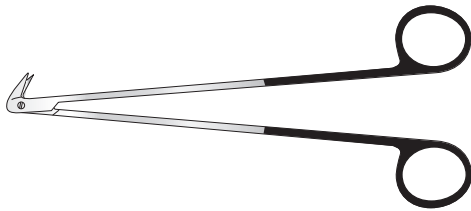

Code	Description
SC-THO/077	125° angled on side

Boyd Scissor

Supercut, slight curve

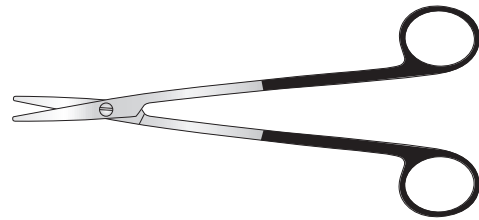

Code	Description
SC-THO/047	180mm long

Lobectomy Scissors

Curved on flat

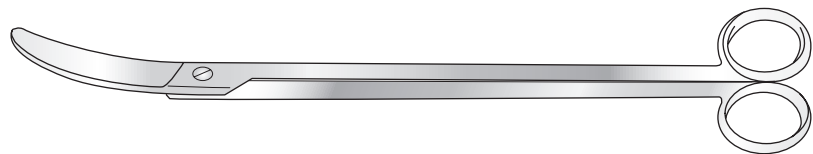

Code	Description
SC-THO/001b	305mm long

Nelson Lobectomy Scissor

Tungsten carbide, curved on flat, 230mm long

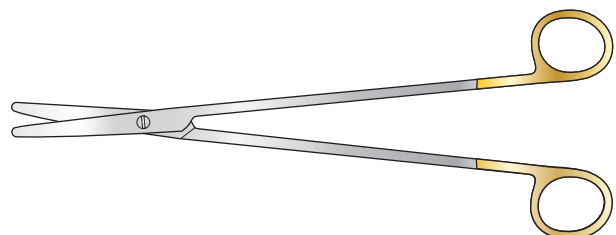

Code
SC-THO/057



FOR INFORMATION ON
BLACK AND GOLD BOWS
SEE PAGE 23

Needle Holders

Needle Holder and Wire Twister

For sternum wire, left-handed, 300mm long

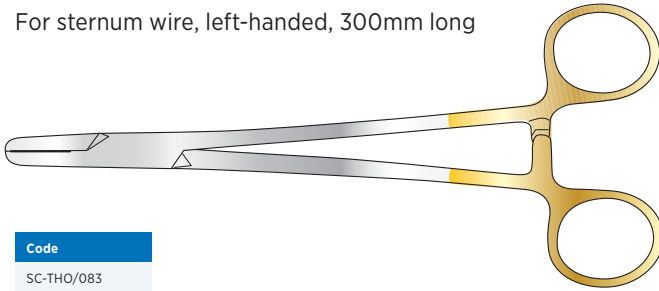

Code

SC-THO/083

Julian Needle Holder

Light, delicate model, with tungsten carbide jaws
220mm long

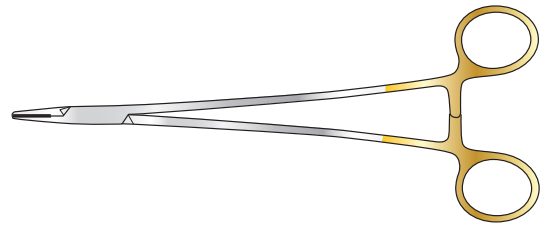

Code Description

SC-THO/081	
SC-THO/081a	Left-handed

Rochester Needle Holder

Light, delicate model, with tungsten carbide jaws
190mm long

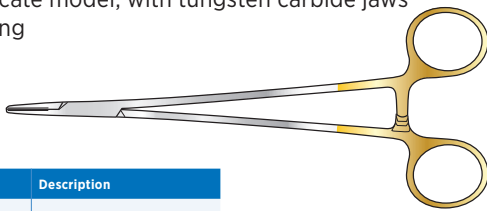

Code Description

SC-THO/082	
SC-THO/082a	Left-handed

DeBakey Needle Holder

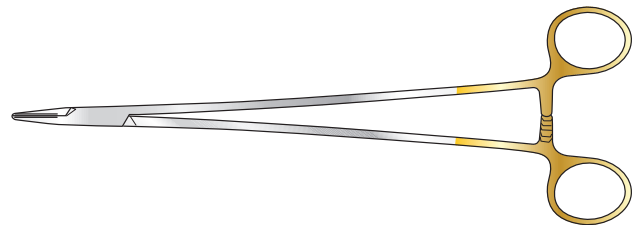

Stratte Needle Holder

210mm long

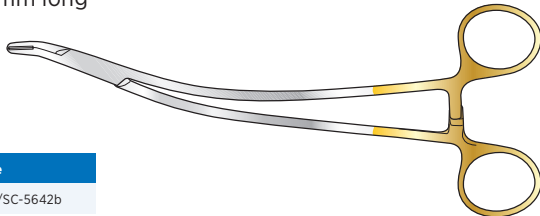

Code

THO/SC-5642b

Code Description

THO/SC-5642a	250mm long
SC-GI/502A	165mm very delicate
SC-GI/502	180mm tungsten carbide
SH003944	260mm long straight with tungsten carbide inserts
SC-5642A	240mm long
SC-GI/036BM	Tungsten carbide delicate 230mm long
SC-GI/037BM	Tungsten carbide delicate 250mm long
SC-GI/038BM	Tungsten carbide delicate 305mm long

Castroviejo Needle Holder

Code	Description
SC-OP/021	140mm long, with catch
SC-OP/020	140mm long, without catch

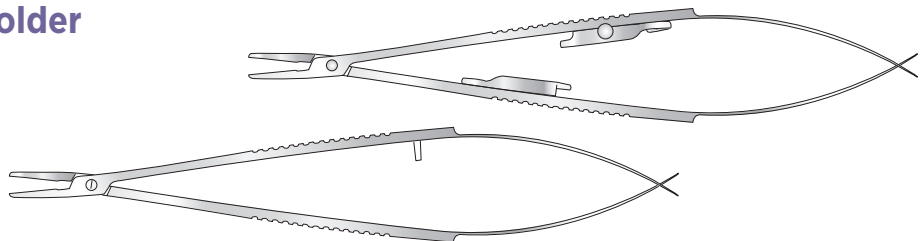

Diamond dust jaws

Code	Description
SC-THO/060	180mm long, without catch
SC-THO/061	200mm long, without catch
SC-THO/062	215mm long, without catch



ALSO AVAILABLE WITH CATCH - ADD SUFFIX CTH TO CODE

Tungsten carbide jaws

Code	Description
SC-THO/058a	180mm long
SC-THO/058	200mm long
SC-THO/059	215mm long

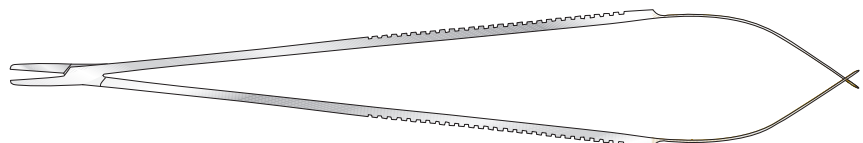

ALSO AVAILABLE WITH CATCH - ADD SUFFIX CTH TO CODE

Retractors

Blanco Valve Leaflet Retractor

280mm long



Code
SC-THO/041

Harrington Splanchnic Retractor

Small size, end of blade
38mm wide x 127mm deep
satin finish handle

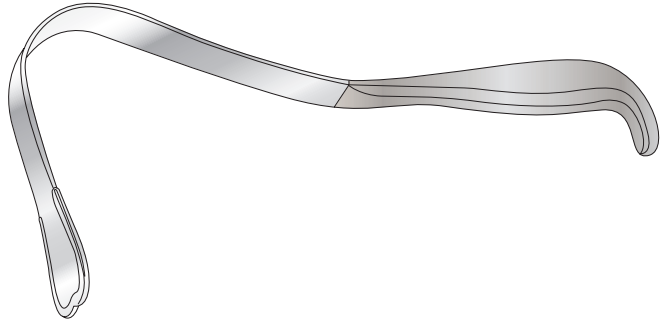

Code	Description
SC-THO/011	320mm long

Brocks Erecton Spinal Back End Retractor

215mm long

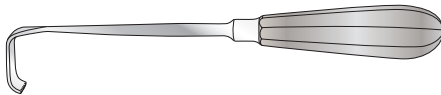

Code	Description
SC-THO/054	13 x 28mm

Cleland Valve Leaflet Retractor

250mm long



Code
SC-THO/097

Ross Retractor

250mm long

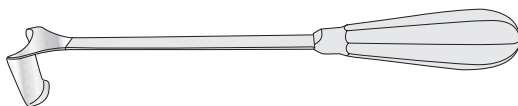

Code	Description	Code	Description
SC-THO/089	16mm x 15mm blade	SC-THO/089c	27mm x 13mm blade
SC-THO/089a	23mm x 13mm blade	SC-THO/089d	27mm x 27mm blade
SC-THO/089b	24mm x 16mm blade	SC-THO/089e	25mm x 38mm blade

Tudor Edwards Retractor

25mm Wide

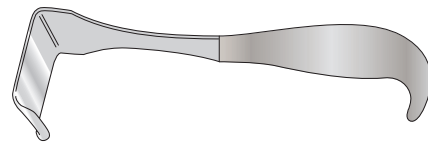

Code	Description
SC-THO/013	205mm long

Allison Lung Retractor

Satin finish handle

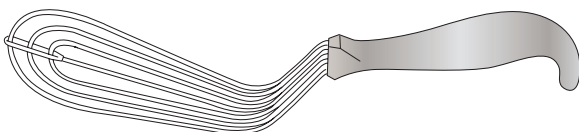

Code	Description
SC-THO/012a	Infant
SC-THO/012b	Child, 280mm blade
SC-THO/012c	Adult, 300mm blade

Coolley Atrial Retractor

260mm overall length

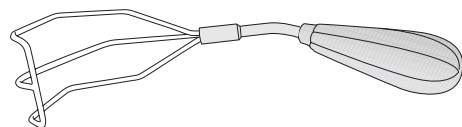

Code	Description
SC-THO/046	Right
SC-THO/046a	Left

Finochietto Rib Spreader

Straight arms, 20mm square blades

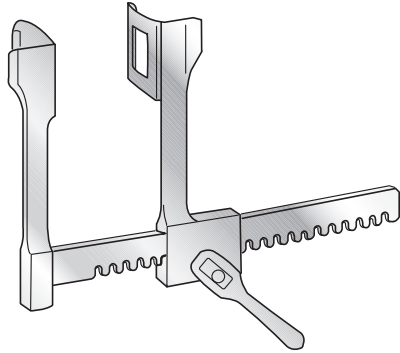

Code	Description
SC-THO/006	Infant, maximum opening 80mm x 60mm long
SC-THO/037	Adult, maximum opening 200mm, blades 44 x 65mm

Morse-Favaloro Rib Spreader

Curved arms, 275mm long

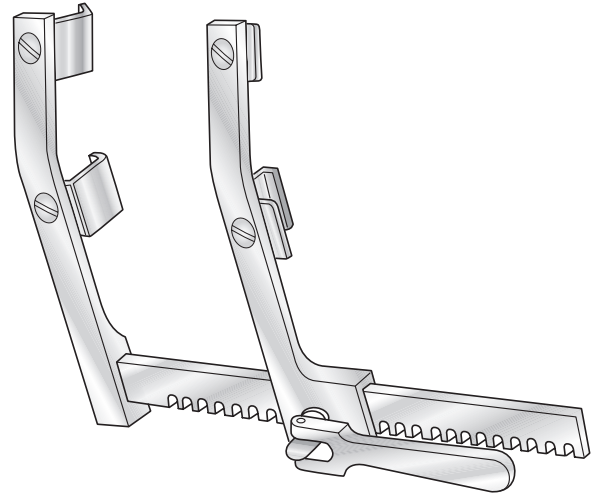

Code	Description
SC-THO/103	Swivel blades 215mm long
SC-THO/103a	Swivel blades 185mm long

IMA Rib Spreader

Converts left or right

Code	Description
SC-THO/102	Standard frame only
SC-THO/102a	Ministernotomy frame only
SC-THO/102b	Complete, standard, 1 x frame, 1 x 100mm long x 20mm wide U shaped blade, 1 x claw blades 28mm and 32mm deep
SC-THO/102c	Complete, ministernotomy, 1 x frame, 1 x 30mm long x 20mm wide U shaped blade, 1 x claw blades 43mm and 50mm deep

Claw blade only

Code	Description
SC-THO/102d	28mm deep
SC-THO/102e	32mm deep
SC-THO/102f	38mm deep
SC-THO/102g	43mm deep
SC-THO/102h	50mm deep

U shaped blade only

Code	Description
SC-THO/102i	100mm long x 20mm wide
SC-THO/102j	100mm long x 25mm wide
SC-THO/102k	30mm long x 20mm wide

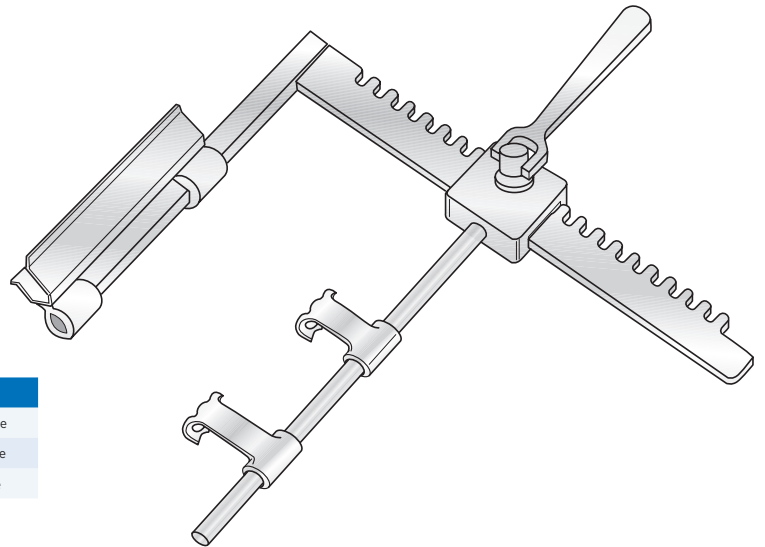

Price Thomas Rib Spreader

Code	Description
SC-THO/99	Complete with 3 pairs of blades, key, 250, 215, 68mm
SC-THO/99a	Blade only, 50mm x 38mm, pair
SC-THO/99b	Blade only, 50mm x 45mm, pair
SC-THO/99c	Blade only, 50mm x 65mm, pair
SC-THO/99d	Nut and bolt for blade only
SC-THO/99e	Frame only
SC-THO/99f	Key only

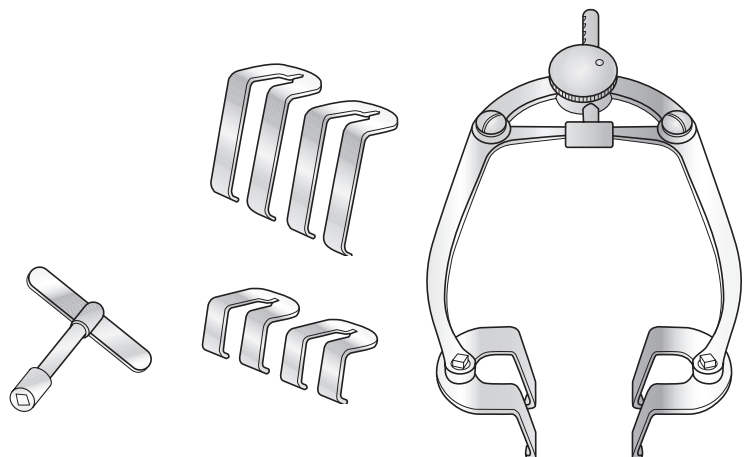

Rib Spreaders

Sellors Rib Spreader

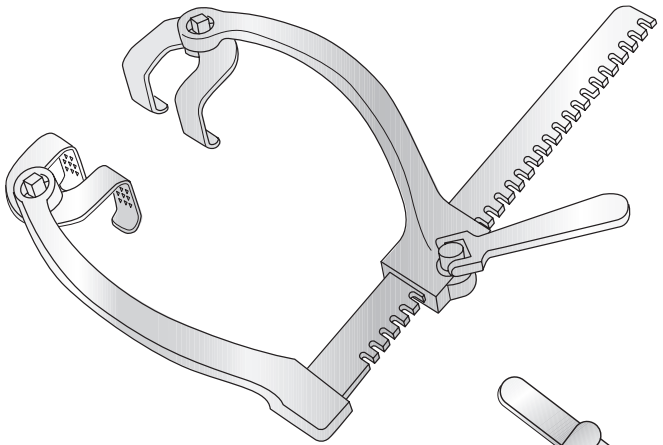

Code	Description
SC-THO/100	Complete with 3 pairs of blades, key,
SC-THO/100a	Blade only, 50mm x 38mm, pair
SC-THO/100b	Blade only, 50mm x 45mm, pair
SC-THO/100c	Blade only, 50mm x 65mm, pair
SC-THO/100d	Frame only
SC-THO/100e	Nut and bolt for blade only
SC-THO/100f	Key only

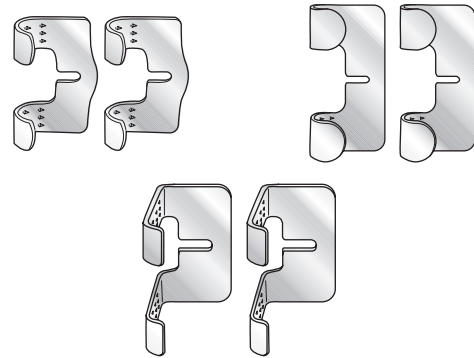

Harefield sternal blade only, pair

Code	Description
SC-THO/100g	70 x 30mm
SC-THO/100h	120 x 30mm

Harefield scapula blade only, pair

Code	Description
SC-THO/100i	75 x 70mm

Ronald Edwards Rib Spreader

Curved arms, fenestrated

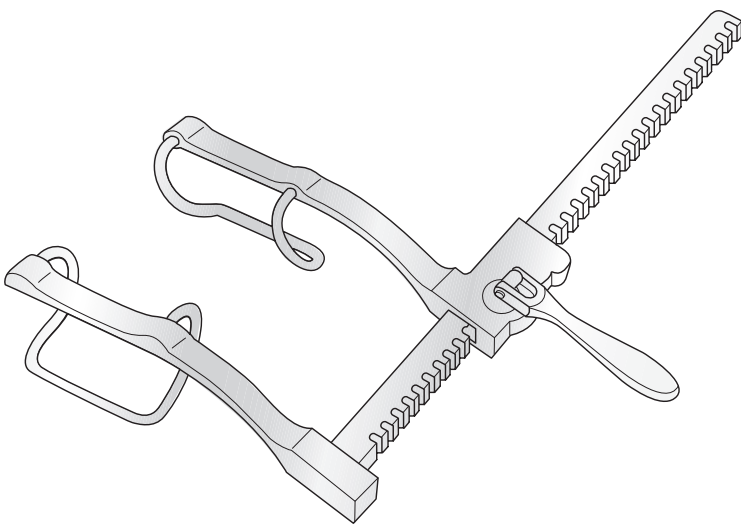

Code	Description
SC-THO/104	Infant, 100mm, 25mm x 30mm blades
SC-SH-5158	Child, 150mm, 30mm x 50mm blades
SC-SH-5720	Adult, 245mm, 65mm x 75mm blades

Bailey Rib Approximator and Spreader

Combined, satin finish

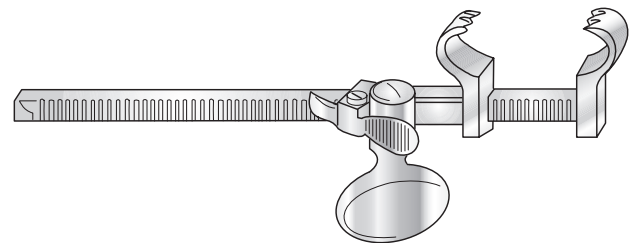

Code	Description
SC-THO/003	160mm long

Sellors Rib Approximator and Spreader

Combined action, satin finish

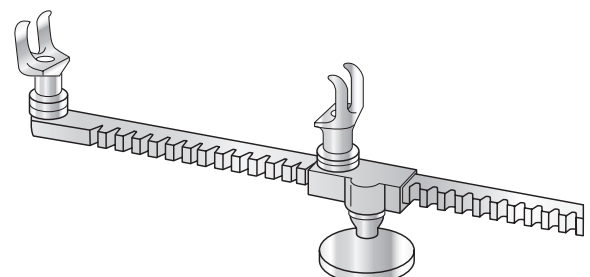

Code	Description
SC-THO/002	195mm long

Cooley Rib Spreader

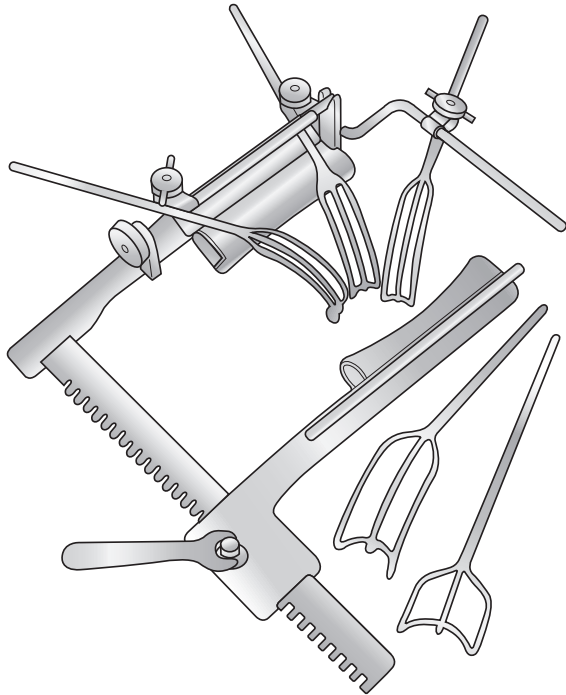

Code	Description
SC-43950-50	Adult, 40mm x 110mm blades, complete with cosgrove mounting bars
SC-43950-90	Adult, 40mm x 110mm blades, complete with cosgrove mitral valve retractor attachment, 5 x blades, 3 x clamp, 1 x side arm

Wells Rib Spreader

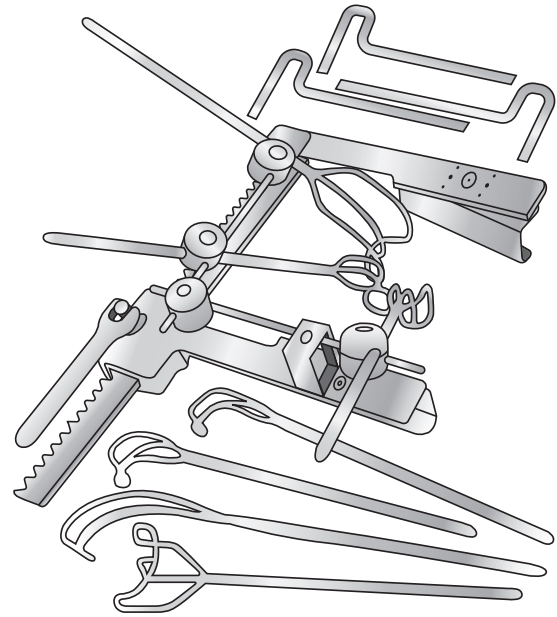

Code	Description
SC-44080-65	Small rake retractor on shaft
SC-44080-80	Frame only, 90mm wide x 25mm deep blades
SC-44080-90	Complete, frame, pillar clamp, 4 x ball clamps, 2 x mounting bars, hex keys, 1 x tricuspid rake ret, 2 x small, medium and large rake ret

Tudor Edwards Rib Spreader

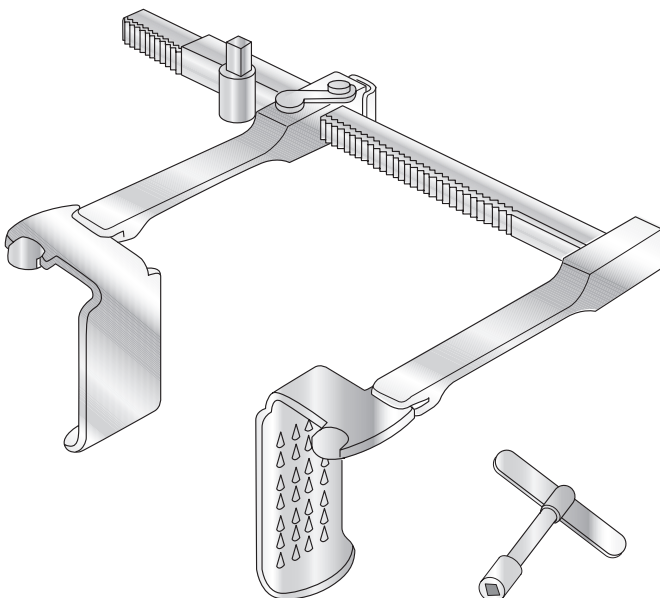

Code	Description
SC-THO/101	Complete, 2 of each blade, plus key
SC-THO/101a	25mm blade only, pair
SC-THO/101b	50mm blade only, pair
SC-THO/101c	75mm blade only, pair

Tuffier Rib Spreader

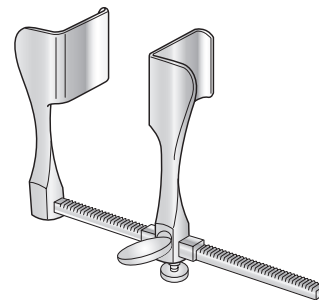

Code	Description
SC-THO/005	Blades 25mm deep x 19mm wide

Vehmehren Rib Holder and Costotome

Satin finish handles

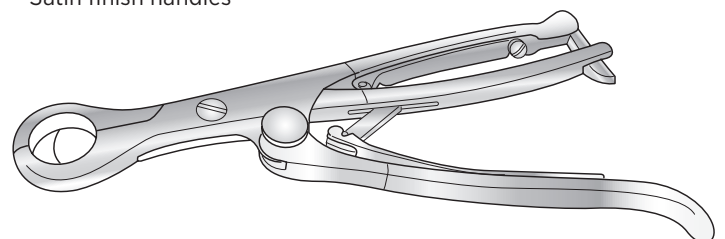

Code	Description
SC-THO/010	240mm long

Rib Shears and Lung Forceps

Giertz Rib Shears

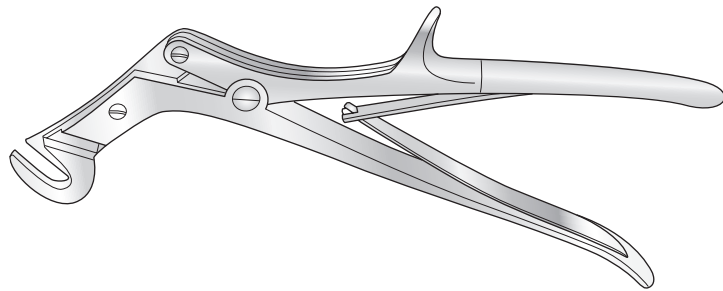

Code	Description
SC-THO/041	270mm long

Tudor Edwards Rib Shears

Compound action, anterior

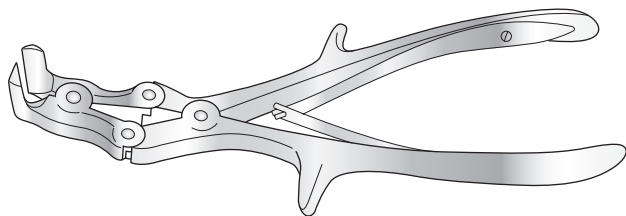

Code	Description
SC-THO/042	235mm long

Mayo Lung Forceps

Fenestrated, semi-circular jaw, satin finish

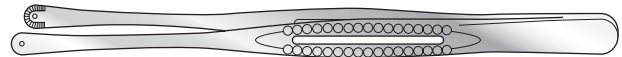

Code	Description
SC-THO/014	230mm long

Special Care Needed For Your Thoracic Instruments

Staining



Beware of the use of Saline during surgery. This can be very damaging to any instrument if not immediately rinsed after surgery. Saline is highly corrosive. The image shows damage to the passive surface of an instrument.

Rusting



Due to the nature of their use, Thoracic Retractors can tarnish or present rust easily. These retractors can be fully refurbished and passivated by Surgical Holdings.

Tudor Edwards Periosteal Elevator

First rib, 175mm long

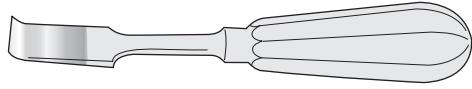

Code	Description
SC-THO/009b	18mm wide

Doyen Periosteal Elevator

Satin finish handle

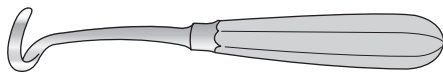

165mm long

Code	Description
SC-OR/N031	Right
SC-OR/N032	Left

180mm long

Code	Description
SC-OR/256	Right
SC-OR/255	Left

Blalock Hook

249mm long



Code	Description
SC-THO/042	45° angle, 5mm tip
SC-THO/043b	90° angle, 5mm tip

Ross (Papworth) Ventricular Sucker

33mm long

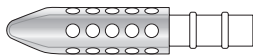

Code	Description
SC-THO/PAP001	Bullet

Ross (Papworth) Sump Sucker

42mm long

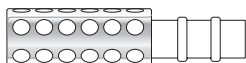

Code	Description
SC-THO/PAP002	Round end

Ross (Papworth) Flat Sucker

42mm long

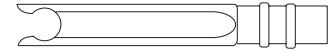
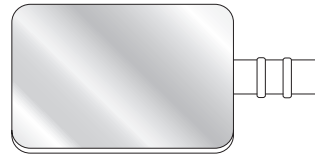

Code
SC-THO/PAP003

Ross Probe

200mm long

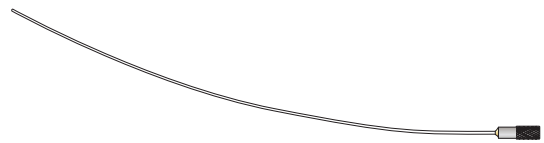

Code	Description
SC-THO/055	1mm
SC-THO/055a	1.5mm

Tibbs Arterial Cannula

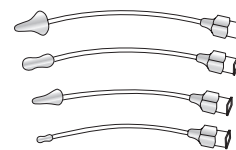

GU pattern

Code	Description	Code	Description
SC-TIB/001	Set of four	SC-TIB/006	Large cone
SC-TIB/002	Large cone	SC-TIB/007	Large olive
SC-TIB/003	Large olive	SC-TIB/008	Small cone
SC-TIB/004	Small cone	SC-TIB/009	Small olive
SC-TIB/005	Small olive	SC-TIB/010	Set of four